

Σ -mini Series SGMM/SGDF USER'S MANUAL

AC Servomotors and Driver

SGMM Servomotor
SGDF Servopack



Safety Information

The following conventions are used to indicate precautions in this manual. Failure to heed precautions provided in this manual may result in serious or possibly even fatal injury or damage to the products or to related equipment and systems.



Indicates precautions that, if not heeded, could result in loss of life or serious injury.



Indicates precautions that, if not heeded, could result in relatively serious or minor injury, damage to the product, or faulty operations.

In some instances, items described in  may also result in a serious accident.

Visual Aids

The following aids are used to indicate certain types of information for easier reference.



Indicates references for additional information.



Indicates definitions of difficult terms that have not been previously explained in this manual.

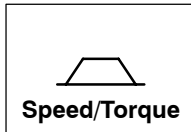

Indicates information that is applicable only to Servopacks for speed/torque control (Model SGDF-□□CS).

If neither this icon nor the following icon appears, the description is applicable to both types of Servopack.



Indicates information that is applicable only to Servopacks for position control (Model SGDF-□□CP).

If neither this icon nor the previous icon appears, the description is applicable to both types of Servopack.

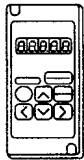

Indicates information explaining the operating procedure using Hand-held Digital Operator (Model JUSP-OP02A-3).

CONTENTS

Safety Precautions	xi
CHAPTER 1 BASIC OPERATION	1-1
1.1 Precautions	1-2
1.2 Installation	1-4
1.2.1 Checking on Delivery	1-4
1.2.2 Installing the Servomotor	1-6
1.2.3 Installing the Servopack	1-9
1.2.4 Power Loss	1-11
1.3 Connection and Wiring	1-12
1.3.1 Connecting to Peripheral Devices	1-12
1.3.2 Main Circuit Wiring and Power ON Sequence	1-14
1.3.3 Examples of Connecting Host Controllers	1-16
1.4 Conducting a Test Run	1-23
1.4.1 Test Run in Two Steps	1-23
1.4.2 Step 1: Test Run for Servomotor without Load	1-24
1.4.3 Step 2: Test Run with the Servomotor Connected to the Machine	1-28
1.4.4 Supplementary Information on Test Run	1-29
1.4.5 Minimum Parameters and Input Signals	1-30
CHAPTER 2 APPLICATIONS	2-1
2.1 Setting Parameters According to Machine Characteristics	2-4
2.1.1 Changing Motor Rotation Direction	2-4
2.1.2 Torque Limit	2-5
2.2 Setting Parameters According to Host Controller	2-9
2.2.1 Speed References	2-9
2.2.2 Position References	2-13
2.2.3 Encoder Output	2-17
2.2.4 Contact I/O	2-21
2.2.5 Electronic Gear	2-24
2.2.6 Contact Input Speed Control	2-28
2.2.7 Torque Control	2-32
2.2.8 Reference Pulse Inhibit Function (INHIBIT)	2-36
2.2.9 Reference Pulse Input Filter Selection Function	2-37
2.3 Setting Up the Σ -Series Servopack	2-38
2.3.1 Parameters	2-38
2.3.2 Jog Speed	2-39
2.4 Setting Stop Mode	2-40
2.4.1 Offset Adjustment	2-40
2.4.2 Zero-clamp	2-41
2.4.3 Holding Brake	2-43
2.5 Running the Motor Smoothly	2-46
2.5.1 Soft Start Function	2-46
2.5.2 Smoothing	2-47

CONTENTS

2.5.3	Gain Adjustment	2-47
2.5.4	Offset Adjustment	2-48
2.5.5	Torque Reference Filter Time Constant	2-48
2.6	Minimizing Positioning Time	2-49
2.6.1	Autotuning	2-49
2.6.2	Servo Gain	2-49
2.6.3	Feed-forward Control	2-51
2.6.4	Proportional Control	2-51
2.6.5	Setting Speed Bias	2-52
2.6.6	Mode Switch	2-53
2.6.7	Speed Loop Compensation	2-58
2.7	Designing a Protective Sequence	2-60
2.7.1	Servo Alarm Output	2-60
2.7.2	Servo ON Input Signal	2-62
2.7.3	Positioning Complete Output	2-63
2.7.4	Speed Coincidence Output	2-64
2.7.5	Running Output Signal	2-65
2.8	Special Wiring	2-67
2.8.1	Wiring Precautions	2-67
2.8.2	Wiring for Noise Control	2-69
2.8.3	Using More Than One Servo Drive	2-73
2.8.4	Connector Terminal Layouts	2-74
CHAPTER 3 USING THE DIGITAL OPERATOR		3-1
3.1	Basic Operations	3-2
3.1.1	Connecting the Digital Operator	3-2
3.1.2	Resetting Servo Alarms	3-3
3.1.3	Basic Functions and Mode Selection	3-4
3.1.4	Operation in Status Display Mode	3-5
3.1.5	Operation in Parameter Setting Mode	3-7
3.1.6	Operation in Monitor Mode	3-9
3.2	Applications	3-13
3.2.1	Operation in Alarm Traceback Mode	3-13
3.2.2	Operation Using the Digital Operator	3-15
3.2.3	Autotuning	3-16
3.2.4	Reference Offset Automatic Adjustment	3-21
3.2.5	Reference Offset Manual Adjustment	3-22
3.2.6	Clearing Alarm Traceback Data	3-25
3.2.7	Checking Motor Type	3-26
3.2.8	Checking Software Version	3-26
CHAPTER 4 SERVO SELECTION AND DATA SHEETS		4-1
4.1	Selecting a Servo Drive	4-3
4.1.1	Selecting a Servomotor	4-3

CONTENTS

4.1.2	Selecting a Servopack	4-9
4.2	Servomotor Ratings and Characteristics	4-11
4.2.1	Ratings and Specifications	4-11
4.2.2	Mechanical Characteristics	4-16
4.3	Servopack Ratings and Characteristics	4-18
4.3.1	Ratings and Specifications	4-18
4.3.2	Overload Characteristics	4-25
4.3.3	Starting Time and Stopping Time	4-26
4.3.4	Overhanging Loads	4-26
4.3.5	In-rush Current and Power Loss	4-27
4.4	Servo Drive Dimensional Drawings	4-28
4.4.1	Servomotor Dimensional Drawings	4-28
4.4.2	Servomotor Dimensional Drawings: European Safety Standards	4-37
4.4.3	Servopack Dimensional Drawings	4-45
4.4.4	Digital Operator Dimensional Drawings	4-46
4.5	Selecting Peripheral Devices	4-47
4.5.1	Selecting Peripheral Devices	4-47
4.6	Specifications and Dimensional Drawings of Peripheral Devices	4-50
4.6.1	Cable Specifications and Peripheral Devices	4-50
4.6.2	Motor Cables	4-51
4.6.3	Encoder Cables	4-54
4.6.4	Connector Kits	4-56
4.6.5	Cable with CN1 Connector at One End Only	4-61
4.6.6	Circuit Breaker	4-61
4.6.7	Noise Filter	4-62
4.6.8	Magnetic Contactor	4-62
4.6.9	Surge Suppressor	4-64
4.6.10	Variable Resistor for Speed Setting	4-64
4.6.11	Encoder Signal Converter Unit	4-65
4.6.12	Cables for Connecting PC and Servopack	4-67
CHAPTER 5	INSPECTION AND MAINTENANCE	5-1
5.1	Servo Drive Inspection and Maintenance	5-2
5.1.1	Servomotors	5-2
5.1.2	Servopack	5-3
5.2	Error Diagnosis and Troubleshooting	5-4
5.2.1	Troubleshooting Problems with Alarm Display	5-4
5.2.2	Troubleshooting Problems With No Alarm Display	5-13
5.2.3	Servopack Connection Diagrams	5-15
CHAPTER 6	EMC DIRECTIVE MEASURES	6-1
6.1	Servo Drive Inspection and Maintenance	6-2
6.1.1	What are EN Standards?	6-2
6.1.2	What is the CE Marking?	6-2

CONTENTS

6.1.3	EMC Directive	6-2
6.1.4	TÜV Certification Body Authorized by EU	6-3
6.2	Measures to Satisfy the EMC Directive	6-4
6.2.1	Applicable Servomotors	6-4
6.2.2	Applicable Noise Filter	6-4
6.2.3	Applicable Power Supply	6-4
6.2.4	Motor Cables	6-4
6.2.5	Encoder Cables	6-5
6.2.6	Control I/O	6-7
6.2.7	Digital Operator and Monitoring by Personal Computer	6-7
6.2.8	Cable Core	6-7
6.2.9	Wiring Examples	6-8

APPENDICES

A	Servo Adjustment	A-1
A.1	Σ -Series AC Servopack Gain Adjustment	A-2
A.1.1	Σ -Series AC Servopacks and Gain Adjustment Methods	A-2
A.1.2	Basic Rules for Gain Adjustment	A-3
A.2	Adjusting a Speed-control Servopack	A-4
A.2.1	Adjusting Using Autotuning	A-4
A.2.2	Manual Adjustment	A-5
A.3	Adjusting a Position-control Servopack	A-8
A.3.1	Adjusting Using Autotuning	A-8
A.3.2	Manual Adjustment	A-9
A.4	Gain Setting References	A-13
A.4.1	Guidelines for Gain Settings According to Load Inertia Ratio	A-13
B	List of I/O Signals	B-1
C	List of Parameters	C-1
D	List of Alarm Displays	D-1

INDEX	Index 1
--------------------	----------------

Overview

About this Manual

This manual provides the following information for users of Σ -Series Servomotors and Servo Drives.

- An overview of Servo Systems for first-time users.
- Checking the product on delivery and basic applications of the Servo.
- Servo applications.
- Selecting an appropriate Servo for your needs and placing an order.
- Inspection and maintenance.

Using this Manual

Manual Structure

All chapters in this manual are classified into one or more of three areas according to their contents: A, B, and C. Refer to the applicable chapters for the information required.

A: Chapters explaining how to select a Servo: For users who wish to gain a basic understanding of Σ -Series products or who need to select an appropriate Servo.

B: Chapters explaining how to design a Servo System: For users who intend to design, install, and operate a Σ -Series Servo Control System.

C: Chapters explaining maintenance: For users who are going to maintain and troubleshoot Σ -Series products.

Chapter	Title	Page	Area
CHAPTER 1	Basic Operation	1-1	B
	Describes steps to take when product is received, plus basic wiring and application methods.		
CHAPTER 2	Applications	2-1	B
	Describes the effective usage of Σ -Series features according to application.		
CHAPTER 3	Using the Digital Operator	3-1	B
	Describes operating procedures for Σ -Series Servos, turning features ON and OFF, setting control constants, etc.		
CHAPTER 4	Servo Selection and Data Sheets	4-1	A, B
	Describes selection methods for Σ -Series Servos and peripherals and provides Servo specifications.		
CHAPTER 5	Inspection and Maintenance	5-1	C
	Describes user maintenance and troubleshooting.		
CHAPTER 6	EMC Directive Measures	6-1	B
	Provides the measures to conform to EN standards.		
APPENDICES			
A	Servo Adjustment	A-1	B, C
B	List of I/O Signals	B-1	A, B, C
C	List of Parameters	C-1	B, C
D	List of Alarm Displays	D-1	B, C
INDEX	Index 1	A, B, C

Basic Terms

Meaning of Basic Terms

Unless otherwise specified, the following definitions are used in this manual.

Servomotor: Σ -Series SGMM Servomotor.

Servopack: Σ -Series SGDF Servopack.

Servo Drive: A set including an SGMM/SGDF Servomotor and an SGDF Servopack

Servo System: A complete Servo control system consisting of Servo Drive, host controller, and peripheral devices.

Description of Technical Terms

Technical **terminology** that appears as bold in text is explained briefly at the bottom of the page.

Safety Precautions

The following precautions are for checking products upon delivery, installation, wiring, operation, maintenance and inspections.

■ Checking Products upon Delivery

 CAUTION
<ul style="list-style-type: none">• Always use the Servomotor and Servopack in one of the specified combinations. Not doing so may cause fire or malfunction.

■ Installation

 CAUTION
<ul style="list-style-type: none">• Never use the products in an environment subject to water, corrosive gases, inflammable gases, or combustibles Doing so may result in electric shock or fire.

■ Wiring

 WARNING
<ul style="list-style-type: none">• Ground the equipment ground terminal according to electrical codes (ground resistance: 100 Ω or less). Improper grounding may result in electric shock or fire.

 CAUTION
<ul style="list-style-type: none">• Do not connect a three-phase power supply to the U, V, or W output terminals. Doing so may result in injury or fire.• Securely fasten the power supply terminal screws and motor output terminal screws. Not doing so may result in fire.

■ **Operation**

 **WARNING**

- Never touch any rotating motor parts while the motor is running.
Doing so may result in injury.

 **CAUTION**

- Conduct trial operation on the Servomotor alone with the motor shaft disconnected from machine to avoid any unexpected accidents.
Not doing so may result in injury.
- Before starting operation with a machine connected, change the settings to match the user's constants of the machine.
Starting operation without matching the proper settings may cause the machine to run out of control or malfunction.
- Before starting operation with a machine connected, make sure that an emergency stop can be applied at any time.
Not doing so may result in injury.
- Do not touch the heat sinks during operation.
Doing so may result in burns due to high temperatures.

■ **Maintenance and Inspection**

 **WARNING**

- Never touch the inside of the Servopacks.
Doing so may result in electric shock.
- Do not touch terminals for five minutes after the power is turned OFF.
Residual voltage may cause electric shock.

 **CAUTION**

- Do not disassemble the Servomotor.
Doing so may result in electric shock or injury.
- Do not attempt to change wiring while the power is ON.
Doing so may result in electric shock or injury.

■ General Precautions

Note the following to ensure safe application.

- The drawings presented in this manual are sometimes shown without covers or protective guards. Always replace the cover or protective guard as specified first, and then operate the products in accordance with the manual.
- The drawings presented in this manual are typical examples and may not match the product you received.
- This manual is subject to change due to product improvement, specification modification, and manual improvement. When this manual is revised, the manual code is updated and the new manual is published as a next edition. The edition number appears on the front and back covers.
- If the manual must be ordered due to loss or damage, inform your nearest Yaskawa representative or one of the offices listed on the back of this manual.
- Yaskawa will not take responsibility for the results of unauthorized modifications of this product. Yaskawa shall not be liable for any damages or troubles resulting from unauthorized modification.

©Yaskawa, 1999

All rights reserved. No part of this publication may be reproduced, stored in a retrieval system, or transmitted, in any form, or by any means, mechanical, electronic, photocopying, recording, or otherwise, without the prior written permission of Yaskawa. No patent liability is assumed with respect to the use of the information contained herein. Moreover, because Yaskawa is constantly striving to improve its high-quality products, the information contained in this manual is subject to change without notice. Every precaution has been taken in the preparation of this manual. Nevertheless, Yaskawa assumes no responsibility for errors or omissions. Neither is any liability assumed for damages resulting from the use of the information contained in this publication.

BASIC OPERATION

1

This chapter describes the initial procedures when Σ -Series products are delivered. It also explains the basic methods of connecting and operating Σ -Series products. Both first-time and experienced servo users **must read** this chapter.

1.1	Precautions	1-2
1.2	Installation	1-4
1.2.1	Checking on Delivery	1-4
1.2.2	Installing the Servomotor	1-6
1.2.3	Installing the Servopack	1-9
1.2.4	Power Loss	1-11
1.3	Connection and Wiring	1-12
1.3.1	Connecting to Peripheral Devices	1-12
1.3.2	Main Circuit Wiring and Power ON Sequence	1-14
1.3.3	Examples of Connecting Host Controllers	1-16
1.4	Conducting a Test Run	1-23
1.4.1	Test Run in Two Steps	1-23
1.4.2	Step 1: Test Run for Servomotor without Load	1-24
1.4.3	Step 2: Test Run with the Servomotor Connected to the Machine	1-28
1.4.4	Supplementary Information on Test Run	1-29
1.4.5	Minimum Parameters and Input Signals	1-30

1.1 Precautions

This section provides precautions that must be observed when using Σ -Series products.

Do not connect the Servomotor directly to a commercial power supply.

Do not plug the Servomotor directly into the commercial power supply. Direct connection to the commercial power supply will damage the Servomotor. The Servomotor cannot operate without a Servopack.

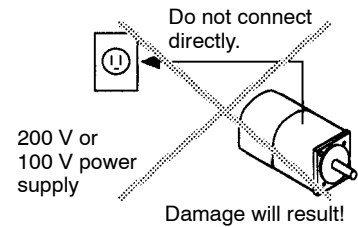

Do not connect or disconnect the connector when power is ON.

Always turn the power OFF before connecting or disconnecting a connector, except for the connector for the Digital Operator.

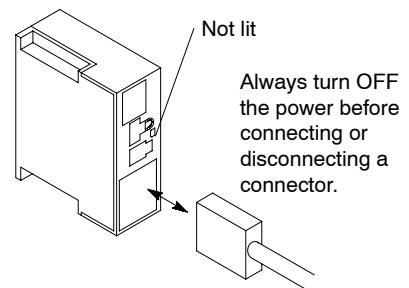

Do not perform inspection or maintenance work for at least 5 minutes after the power is turned OFF.

Even after the power is turned OFF, residual voltage still remains in the capacitor inside the Servopack. If inspection is to be performed after the power is turned OFF, always wait at least 5 minutes to avoid the risk of an electrical shock.

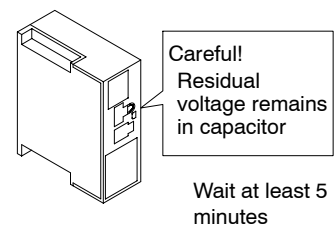

Install the Servopack at least 10 mm from other devices.

The Servopack generates heat. Configure the system layout so that the Servopack is located where it can radiate heat freely. The Servopack must be installed in an environment free from condensation, vibration, and shock.

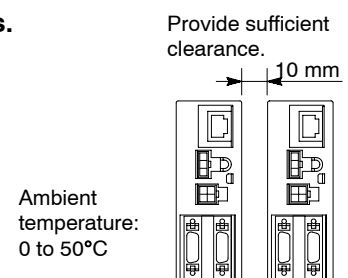

Perform noise reduction and grounding properly.

If the signal line is noisy, vibration or malfunction will result.

Install the system according to the following precautions.

- Separate high-voltage cables from low-voltage cables.
- Use cables as short as possible.
- Be sure to ground (ground resistance 100 Ω or less) for the Servomotor and Servopack.
- Never use a noise filter for the power supply between the Servomotor and Servopack.

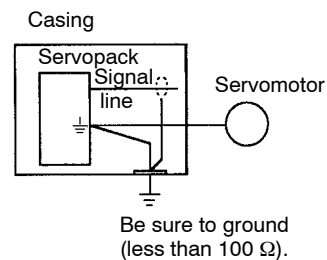
**Do not perform continuous operation under overhanging load.**

Continuous operation cannot be performed by rotating the motor from the load and applying regenerative braking. Regenerative braking by the Servopack can be applied only for a short period, such as when the motor is stopped.

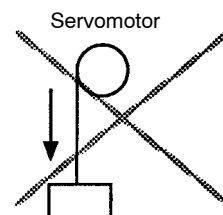

Do not apply regenerative braking continuously.

Do not operate the Servomotor by turning the power ON and OFF.

Frequently turning the power ON and OFF causes the internal circuit elements to deteriorate. Always start or stop the Servomotor by using reference pulses.

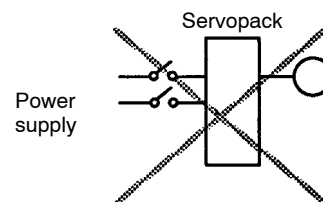

Do not start and stop by turning power ON and OFF

1.2 Installation

This section describes how to check Σ -Series products on delivery and how to install them.

1.2.1 Checking on Delivery

When Σ -Series products are delivered, check the following items.

Check Items	Remarks
Check if the delivered products are the ones you ordered.	Check the types marked on the nameplates of Servomotor and Servopack (see the following table).
Check if the motor shaft rotates smoothly.	If the motor shaft is smoothly turned by hand, it is normal. If the motor has brakes, however, it cannot be turned manually.
Check for damage.	Check the overall appearance, and check for damage or scratches resulting from transportation.
Check screws for looseness.	Check for looseness by using a screwdriver.

If any of the above items are faulty or incorrect, contact the dealer from which you purchased the products or your Yaskawa representative.

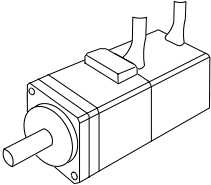
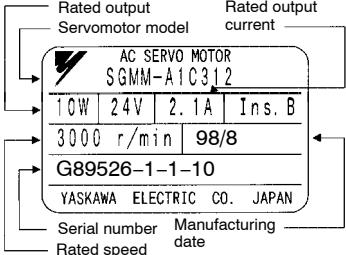
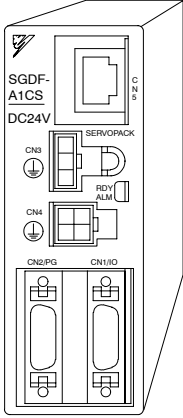
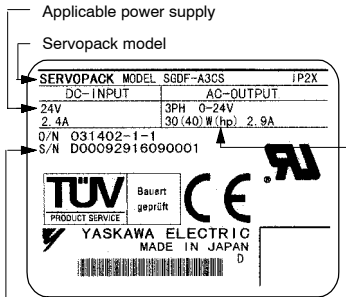
	Appearance	Nameplate	Type
<p>Servo-motors</p>	 <p>Σ-Series SGMM Servomotor</p>	 <p>Rated output Servomotor model Rated output current Serial number Manufacturing date Rated speed YASKAWA ELECTRIC CO. JAPAN</p>	<p>Standard Servomotors</p> <p>SGMM — A1 C 3 1 2 □</p> <p>Σ-Series SGMM Servomotor</p> <p>Rated output A1: 10 W B3: 3 W A2: 20 W B5: 5 W A3: 30 W B9: 10 W</p> <p>Supply voltage B: 100 VAC C: 24 VDC S: EC safety standards, 24 VDC (10 W, 20 W)</p> <p>Encoder specifications 3: 2048 P/R incremental encoder F: 1024 P/R incremental encoder</p> <p>Design revision order</p> <p>Shaft specifications 2: Straight without key 3: Straight with flat seat</p> <p>Option C: With brake (24 VDC)</p> <hr/> <p>Servomotors with Reduction Gears</p> <p>SGMM — A1 C 3 J A 2 □</p> <p>Σ-Series SGMM Servomotor</p> <p>Rated output A1: 10 W A2: 20 W A3: 30 W</p> <p>Supply voltage B: 100 VAC C: 24 VDC S: EC safety standards, 24 VDC (10 W, 20 W)</p> <p>Encoder specifications 3: 2048 P/R incremental encoder</p> <p>With reduction gears</p> <p>Gear ratio A: 1.5 1: 1/5 B: 1/16 2: 1/16 C: 1/25 3: 1/25 (10/20 W) (30 W)</p> <p>Shaft specifications 2: Straight without key 6: Straight with key and tap</p> <p>Option C: With brake (24 VDC)</p>
<p>Servo-packs</p>	 <p>Σ-Series SGDF Servopack</p>	 <p>Applicable power supply Servopack model DC-INPUT AC-OUTPUT Serial number Applicable motor capacity YASKAWA ELECTRIC MADE IN JAPAN</p>	<p>SGDF — A1 C S</p> <p>Σ-Series SGDF Servopack</p> <p>Rated output A1: 10 W B3: 3 W A2: 20 W B5: 5 W A3: 30 W B9: 10 W</p> <p>Supply voltage C: 24 VDC</p> <p>Type S: For speed/torque control P: For position control</p>

1.2.2 Installing the Servomotor

Servomotors can be installed either horizontally or vertically. If, however, the Servomotor is installed incorrectly or in an inappropriate location, the service life will be shortened or unexpected problems will occur. To prevent this, always follow the installation instructions described below and install properly.

Before Installation

The edge of the motor shaft has an anticorrosive coating. Carefully and thoroughly clean off the anti-corrosive coating using a cloth moistened with thinner before installing the motor. Make sure that the thinner is completely wiped off.

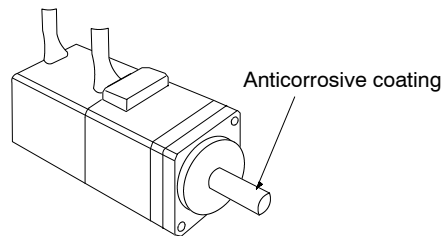

Note Do not get thinner on any other parts of the Servomotor when cleaning the shaft.

Storage Temperature

When the Servomotor is to be stored with the power cable disconnected, store it within the following temperature range.

Between -20 and 60 °C

Installation Site

The Servomotors are designed for indoor use.

Install the Servomotor in an environment which meets the following conditions:

- Free from corrosive and explosive gases
- Well-ventilated and free from dust and moisture
- Ambient temperature of 0 °C to 40 °C
- Relative humidity of 20% to 80% (with no condensation)
- Inspection and cleaning can be performed easily

If the Servomotor is used in a location subject to water or oil mist, install a shield cover over the Servomotor to prevent water or oil mist from entering the Servomotor.

Alignment

Align the shaft of the Servomotor with that of the equipment to be controlled, then connect the shafts with couplings. Install the Servomotor so that alignment accuracy falls within the range shown in the following diagram.

Measure this distance at four different positions in the circumference. The difference between the maximum and minimum measurements must be 0.03 mm or less. (Turn together with couplings)

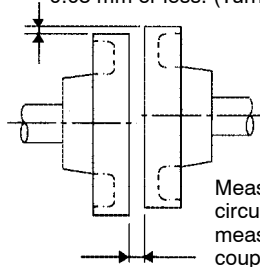

Measure this distance at four different positions in the circumference. The difference between the maximum and minimum measurements must be 0.03 mm or less. (Turn together with couplings)

Note If the shafts are not aligned properly, vibration will occur, resulting in damage to the bearings.

Allowable Load on Shaft End

Mechanical shock to the shaft end must be less than 490 m/s² and must be applied no more than twice.

Design the mechanical system so that **thrust load** and **radial load** applied to the Servomotor shaft end during operation falls within the range shown in the following table.

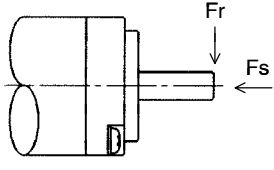
Servomotor Model SGMM-		Allowable Radial Load Fr [N(lb)]	Allowable Thrust Load Fs [N(lb)]	Reference Drawing
Standard	A1C31□□	34.1 (7.7)	14.7 (3.3)	
	A2C31□□	44.1 (9.9)		
	A3C31□□			
	B3CF1□	8 (1.8)	4.0 (0.90)	
	B5CF1□			
	B9CF1□	10 (2.2)		
With Gears	A1C3JA□□	51.9 (11.7)	47.0 (10.5)	
	A2C3JA□□			
	A1C3JB□□	76.4 (17.2)		
	A2C3JB□□			
	A1C3JC□□	89.2 (20.1)		
	A2C3JC□□			

Note a) The box (□) at the end of the model number is for the shaft specifications.

b) The allowable load is applied to the shaft end.



Thrust load and radial load

Thrust load (Fs): Shaft-end load applied parallel to the centerline of a shaft

Radial load (Fr): Shaft-end load applied perpendicular to the centerline of a shaft

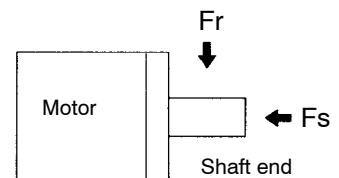

1.2.3 Installing the Servopack

The SGDF Servopack is a book-shaped compact servo controller.

Incorrect installation will cause malfunctions. Always observe the following precautions when installing the Servopack.

Storage:

When the Servopack is to be stored with the power cable disconnected, store it within the following temperature range:

Between $-20\text{ }^{\circ}\text{C}$ and $85\text{ }^{\circ}\text{C}$

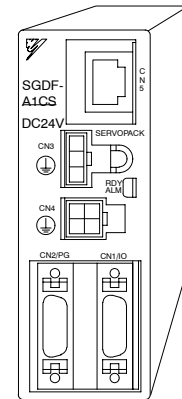

SGDF Servopack

Installation Site

Situation	Notes on Installation
Installed in a control panel	Design the control panel size, Servopack layout, and cooling method so that the ambient temperature of the Servopack does not exceed $50\text{ }^{\circ}\text{C}$.
Installed near a heating unit	Suppress radiation heat from the heating unit and a rise in temperature caused by convection so that the ambient temperature of the Servopack does not exceed $50\text{ }^{\circ}\text{C}$.
Installed near a source of vibration	Install a vibration isolator underneath the Servopack to prevent it from receiving vibration.
Installed in a place subject to corrosive gases	Corrosive gases do not immediately affect the Servopack but will eventually cause contactor-related devices to malfunction. Take appropriate action to prevent corrosive gases.
Others	Do not install in a hot and humid place or where excessive dust or iron powder is present in the air.

Orientation:

Install the Servopack perpendicular to the wall as shown in the figure.

The Servopack must be orientated as shown in the figure because it is designed to be cooled by natural convection.

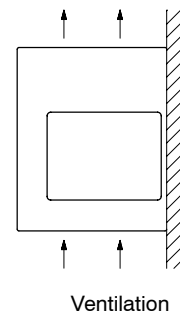

- Firmly secure the Servopack to the mounting surface through the mounting holes.

Installation Method

When installing multiple Servopacks side by side in a control panel, observe the following installation method.

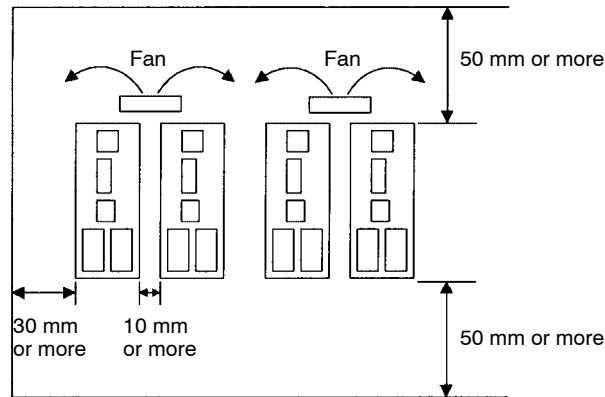

Servopack Orientation

Install Servopack perpendicular to the wall so that the front panel faces outward. The front panel is the side to which the Digital Operator is connected.

Cooling

Provide sufficient space around each Servopack to allow cooling by natural convection or fans as shown in the above diagram.

Adjacent Installation

When installing Servopacks side by side, provide at least 10 mm space between them and at least 50 mm space above and below them as shown in the figure above. Install cooling fans above the Servopacks to prevent the temperature around each Servopack from increasing excessively and also to maintain the temperature inside the control panel evenly.

Control Panel Environment Conditions

- Ambient temperature for Servopack: 0 °C to 50 °C
- Humidity: 90% RH or less
- Vibration: 9.8 m/s²
- Condensation and freezing: None
- Ambient temperature to ensure long-term reliability: 40 °C or less

1.2.4 Power Loss

The amount of power lost by Servopacks at the rated output is shown in the following table.

Servopack Type	Capacity (W)	Inrush Current (Aop)	Output Current (A rms)	Power Loss (W)
SGDF-A1C	10	3.8	2.1	7
SGDF-A2C	20	3.8	2.0	7
SGDF-A3C	30	3.8	2.9	7
SGDF-B3C	3	3.8	1.3	7
SGDF-B5C	5	3.8	1.3	7
SGDF-B9C	10	3.8	1.5	7

1.3 Connection and Wiring

This section describes how to connect Σ -Series products to peripheral devices and explains a typical example of wiring the main circuit. It also describes an example of connecting to main host controllers.

1.3.1 Connecting to Peripheral Devices

This section shows a standard example of connecting Σ -Series products to peripheral devices and briefly explains which peripheral devices can be connected and in which locations to connect them.

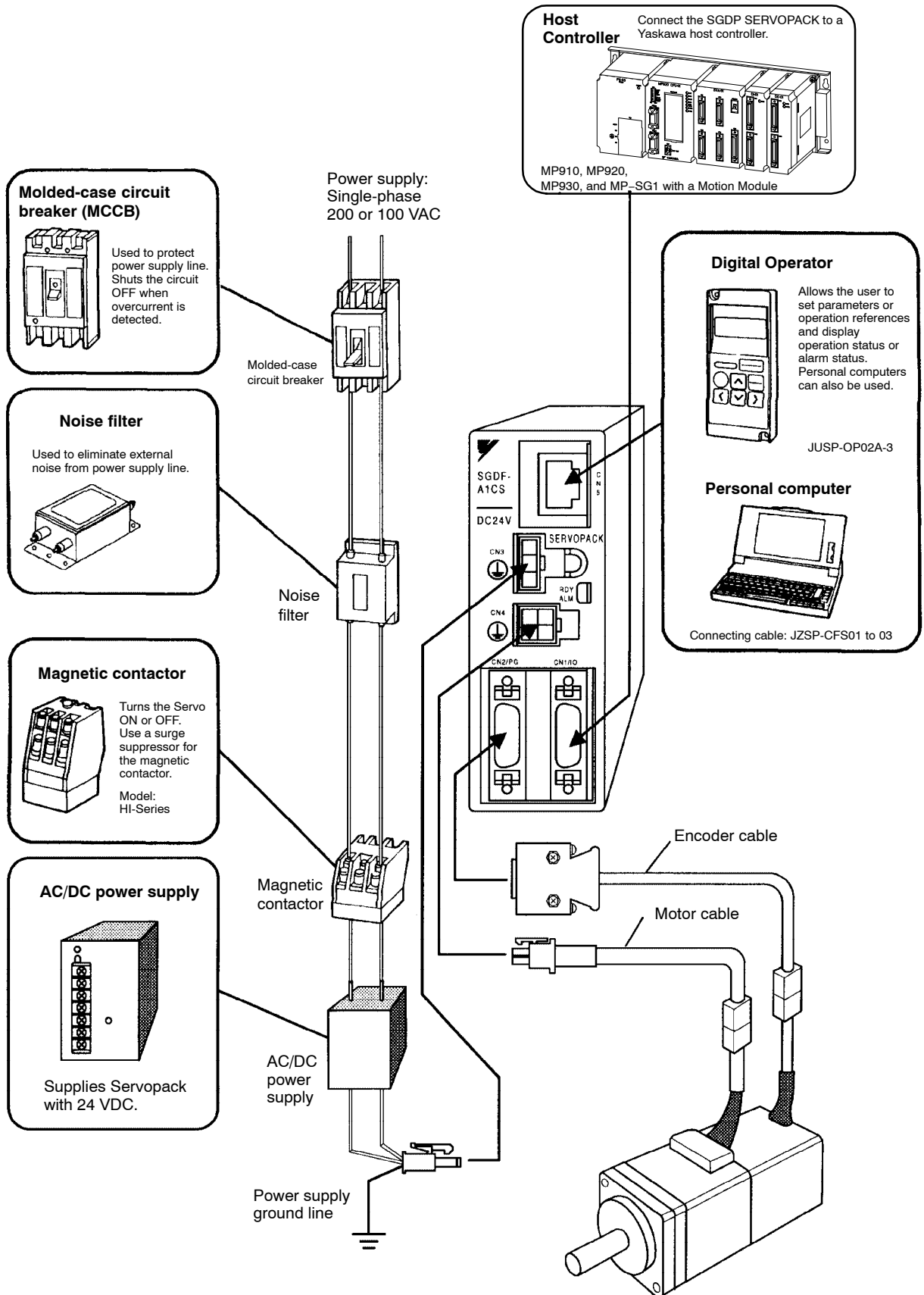

1.3.2 Main Circuit Wiring and Power ON Sequence

This section shows a typical example of wiring the main circuit for Σ -Series Servo, and describes the main circuit terminal functions and power ON sequence.

Typical Wiring Example

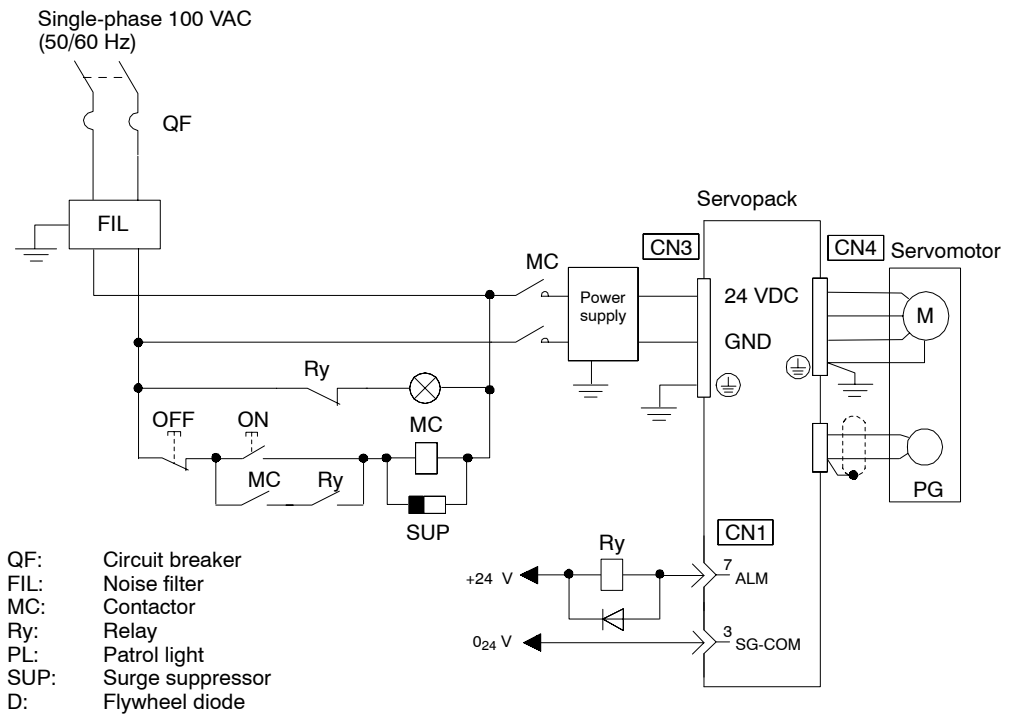

Overview and Functions of Main Circuit Terminals

The following tables show the name and description of each main circuit terminal function.

Terminal Symbol	Name	Description
CN3	Main input terminal	24 VDC \pm 10%
CN4	Motor connection terminal	Connect U to the red motor terminal, V to the white motor terminal, and W to the blue motor terminal.
⊕	Ground terminal	Connect to a ground and to the motor (green).

CN3	
1	⊕
2	GND
3	24 VDC

CN4	
1	Phase U
2	Phase V
3	Phase W
4	⊕

Designing the Power ON Sequence

Observe the following precautions when designing the power ON sequence.

- Design a power ON sequence so that the power is turned OFF when a servo alarm signal is output. (See the previous circuit diagram.)
- Hold down the power ON push-button for at least two seconds. The Servopack outputs a servo alarm signal for approximately two seconds or less when the power is turned ON. This operation is required to initialize the Servopack.

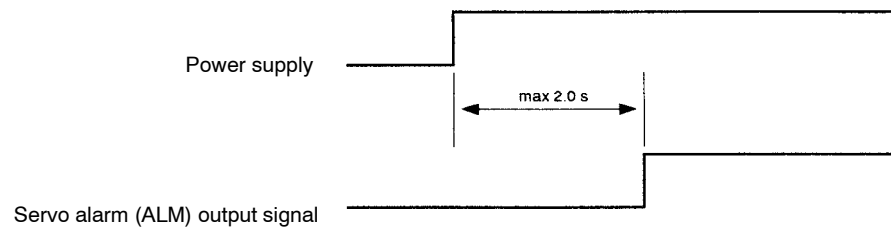

Wiring Precautions

- After turning the power OFF, do not touch the power terminals for 5 minutes. Residual voltage may remain in the Servopack.
- Avoid frequently turning the power ON and OFF. The Servopack has a capacitor in the power supply, so a high charging current flows when the power is turned ON. Therefore, frequently turning the power ON and OFF causes the main power devices (such as capacitors and fuses) to deteriorate, resulting in unexpected problems.

1.3.3 Examples of Connecting Host Controllers

This section provides typical examples of connecting Servopacks to main host controllers. Connection to other host controllers is also possible. Connect to the host controller according to the connection examples shown below by referring to technical documentation for the host controller.

Note This section describes signals related to the Servopack only. For other signals, refer to the relevant technical documentation.

Example of Connecting to PROGIC-8

Servopack for Speed/Torque Control

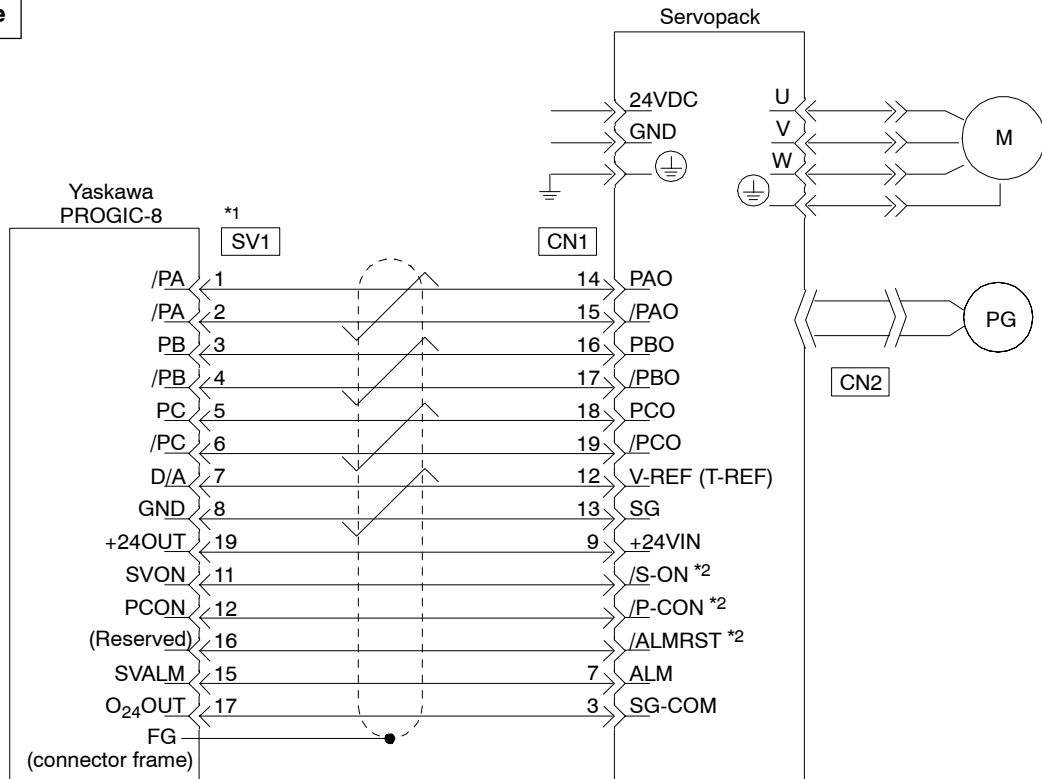
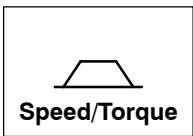

*1 These pin numbers are also applicable to SV2 to SV4.

*2 Set input signals IN1 and IN2 in the parameters.

Example of Connecting to GL-series B2833 Positioning Module

Servopack for Speed/Torque Control

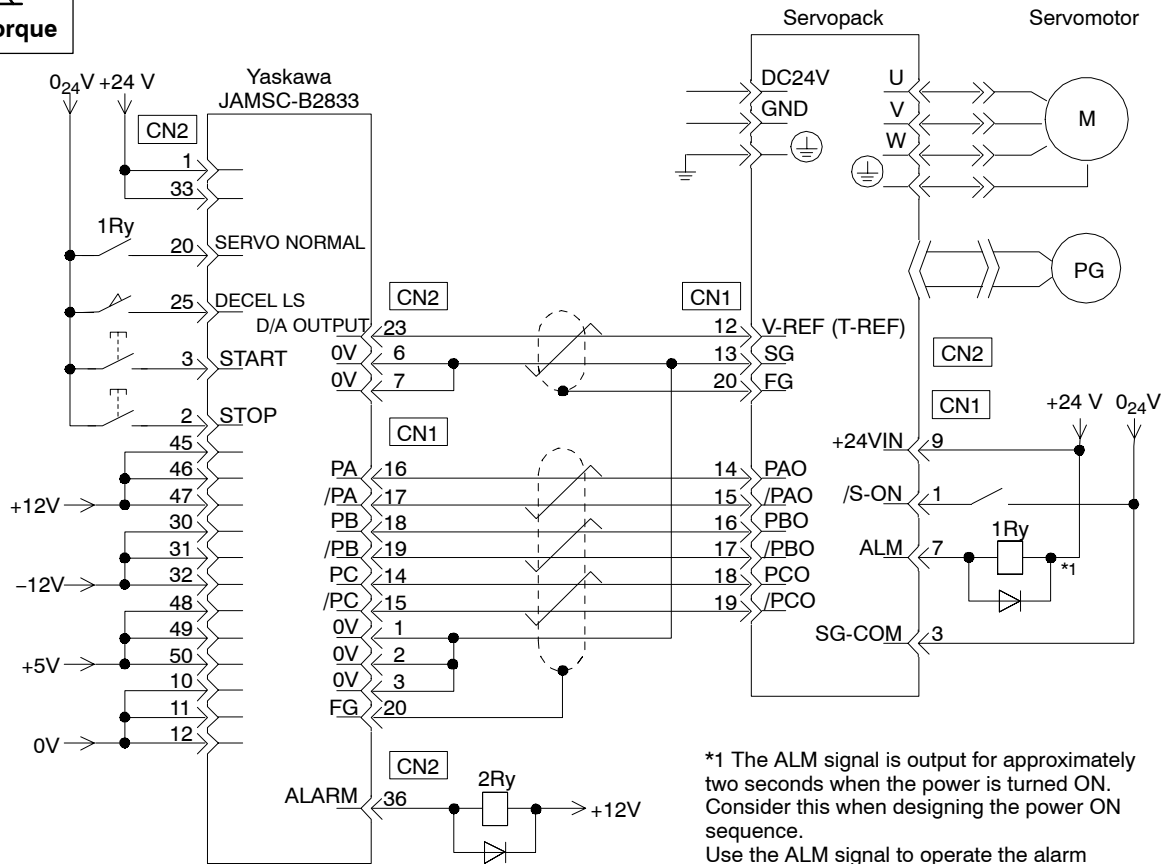
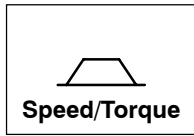

*1 The ALM signal is output for approximately two seconds when the power is turned ON. Consider this when designing the power ON sequence. Use the ALM signal to operate the alarm detection relay (relay 1Ry) and turn OFF the power supply to the Servopack.

Example of Connecting to GL-series B2813 Positioning Module

Servopack for Position Control

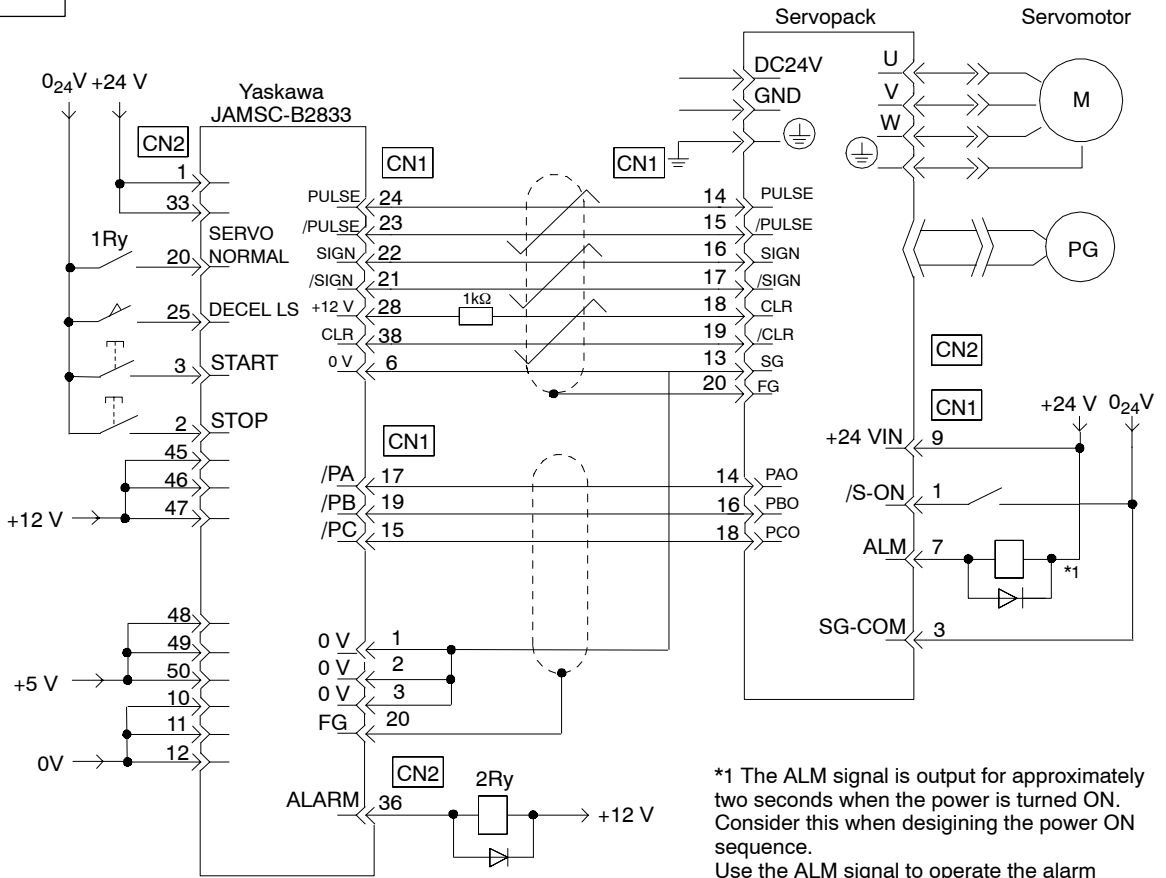
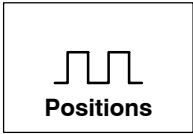

*1 The ALM signal is output for approximately two seconds when the power is turned ON. Consider this when designing the power ON sequence. Use the ALM signal to operate the alarm detection relay (Relay 1Ry) and turn OFF the power supply to the Servopack.

Example of Connecting to OMRON C500-NC222 Position Control Unit

Servopack for Speed/Torque Control

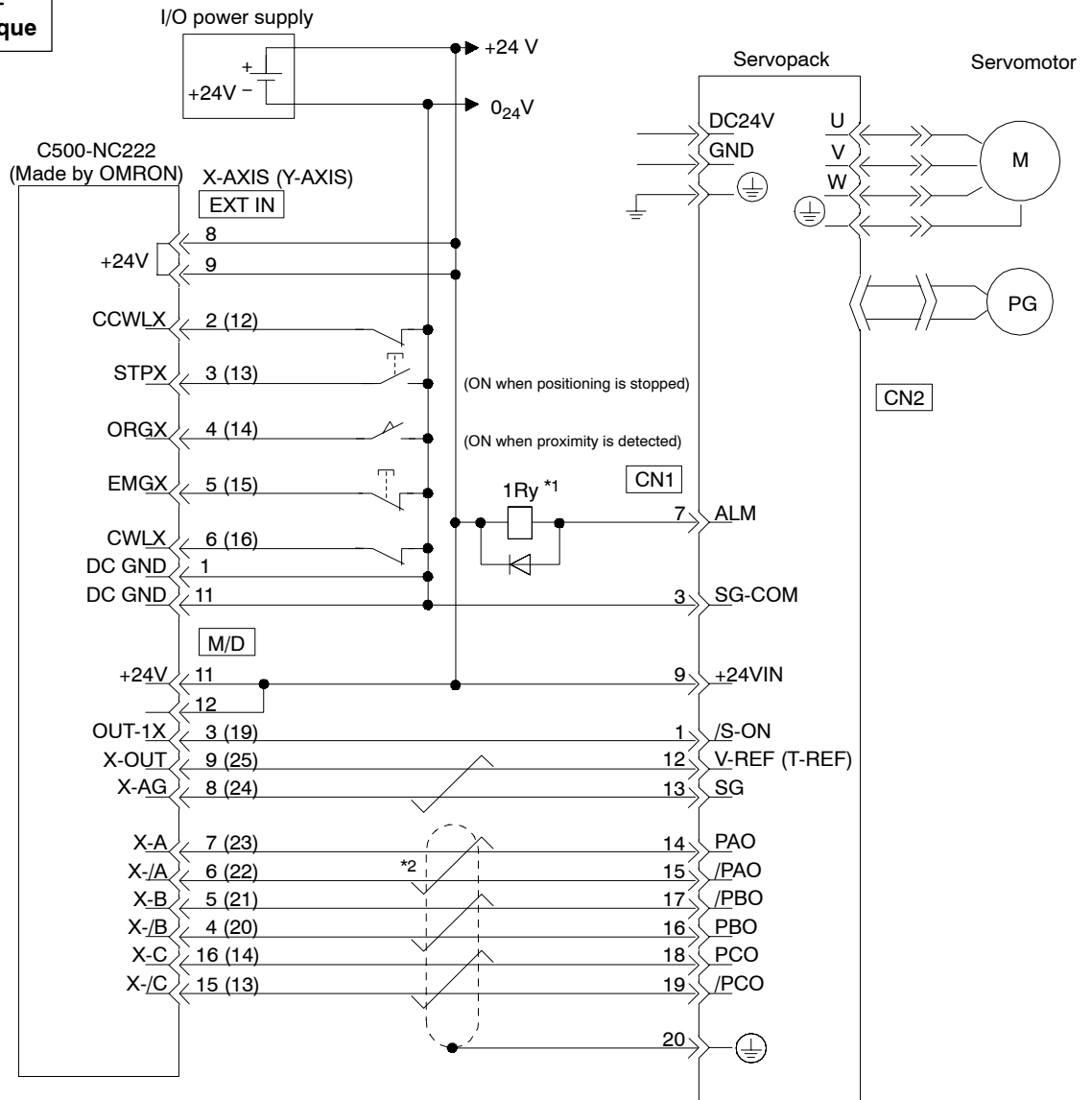
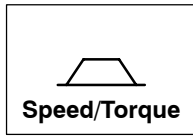

*1 The ALM signal is output for approximately two seconds when the power is turned ON. Consider this when designing the power ON sequence.

Use the ALM signal to operate the alarm detection relay (Relay 1Ry) and turn OFF the power supply to the Servopack.

*2 : Twisted-pair cable

Note Only signals for the OMRON C500-NC221 Position Control Unit and the Yaskawa Servopack are shown here.

Example of Connecting to OMRON C500-NC112 Position Control Unit

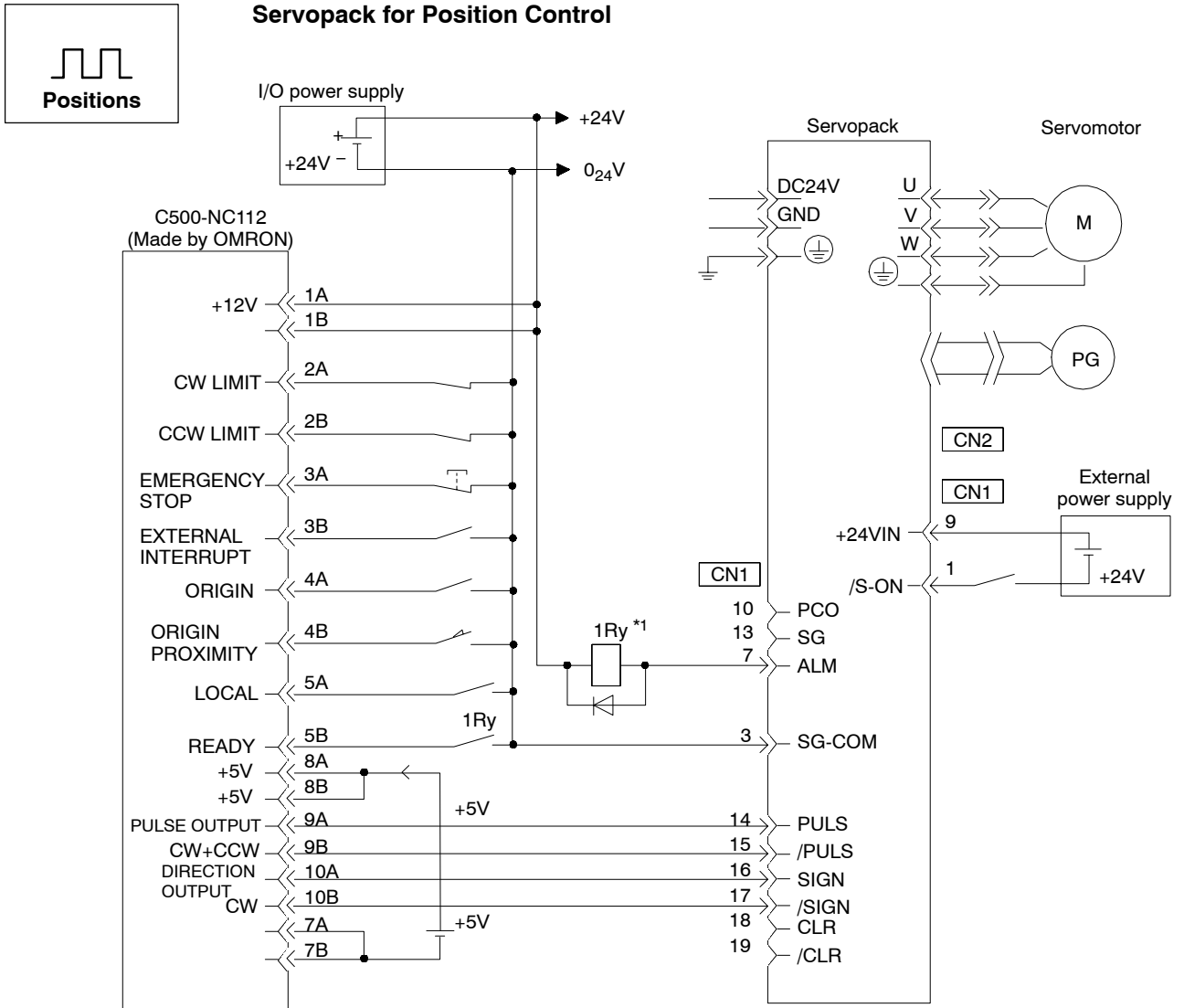

*1 The ALM signal is output for approximately two seconds when the power is turned ON. Consider this when designing the power ON sequence. Use the ALM signal to operate the alarm detection relay (Relay 1Ry) and turn OFF the power supply to the Servopack.

Note Only signals for the OMRON C500-NC112 Position Control Unit and the Yaskawa Servopack are shown here.

Example of Connecting to MITSUBISHI AD72 Positioning Unit

Servopack for Speed/Torque Control

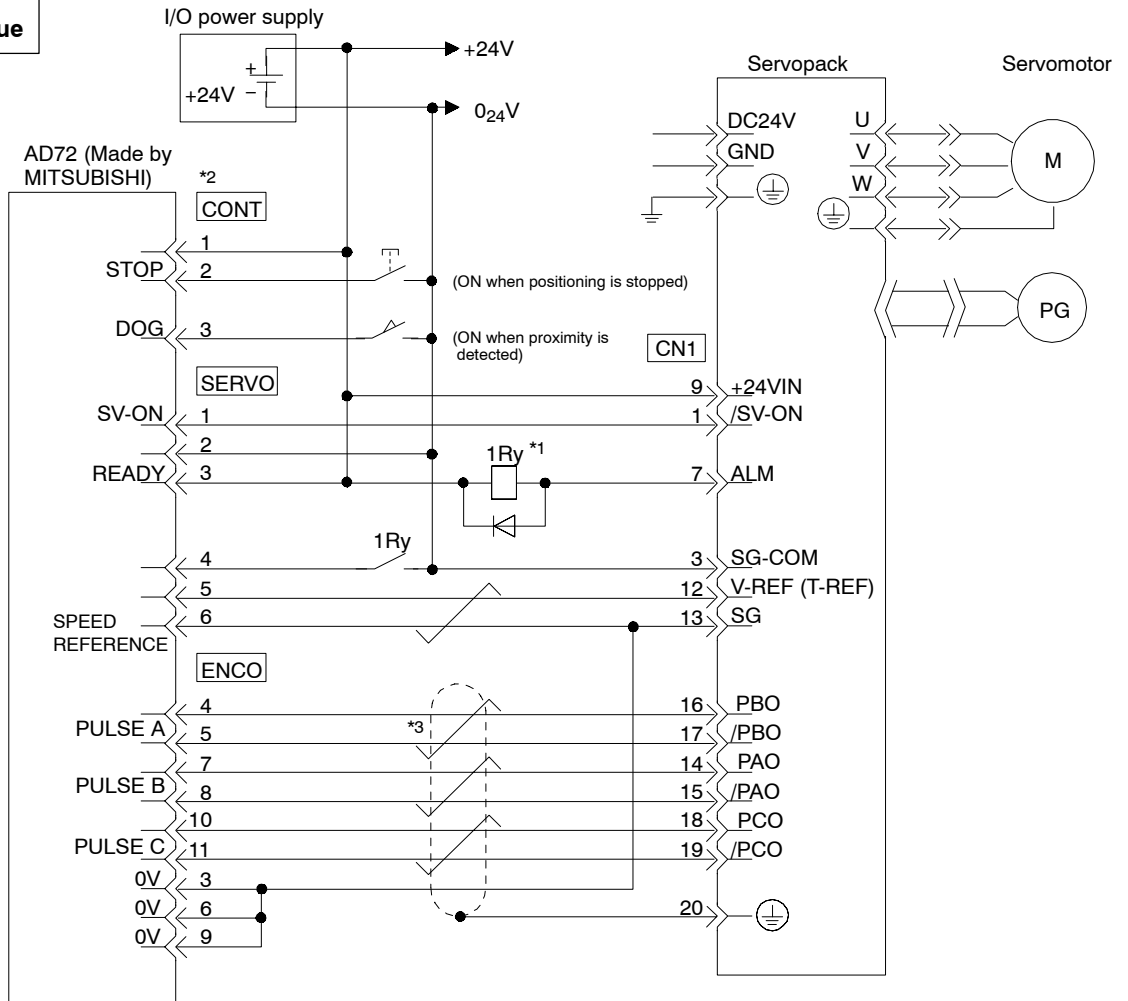
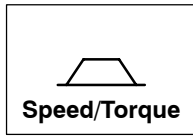

*1 The ALM signal is output for approximately two seconds when the power is turned ON. Consider this when designing the power ON sequence.
Use the ALM signal to operate the alarm detection relay (Relay 1Ry) and turn OFF the power supply to the Servopack.

*2 These pin numbers are the same for both X and Y axes.

*3 : Twisted-pair cable

Note Only signals for the MITSUBISHI AD72 Positioning Unit and the Yaskawa Servopack are shown here.

Example of Connecting to MITSUBISHI AD75 Positioning Unit



Servopack for Position Control

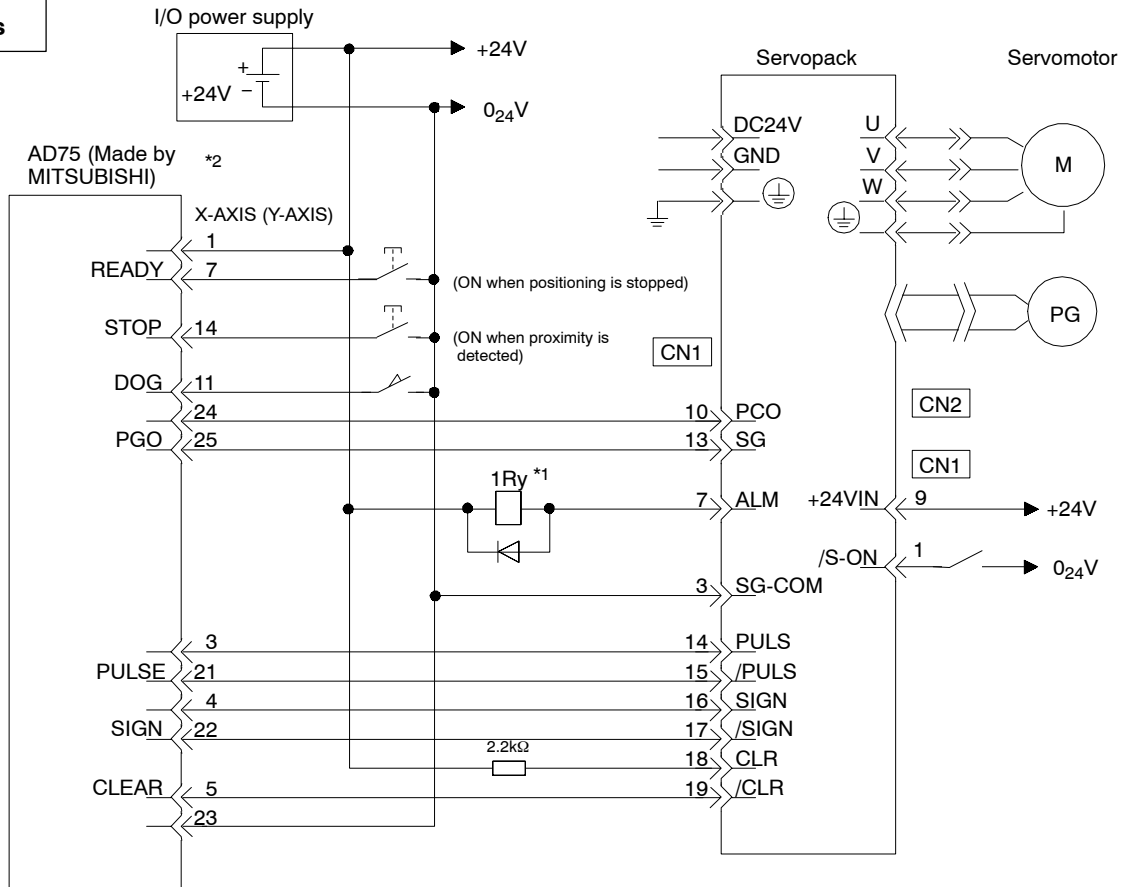

*1 The ALM signal is output for approximately two seconds when the power is turned ON. Consider this when designing the power ON sequence. Use the ALM signal to operate the alarm detection relay (Relay 1Ry) and turn OFF the power supply to the Servopack.

Note Only signals for the MITSUBISHI AD75 Positioning Unit and the Yaskawa Servopack are shown here.

1.4 Conducting a Test Run

This section describes how to conduct a test run in two steps. The test run is divided into two steps. Complete a test run in step 1 first, then proceed to step 2.

1.4.1 Test Run in Two Steps

Conduct the test run when wiring is complete. By following the two steps (step 1 and 2) described below, the test run can be performed safely and correctly.

Note To prevent accidents, the test run in step 1 is conducted for a Servomotor under no load (i.e., Servomotor with all couplings and belts disconnected). Do not run the Servomotor while it is connected to a machine.

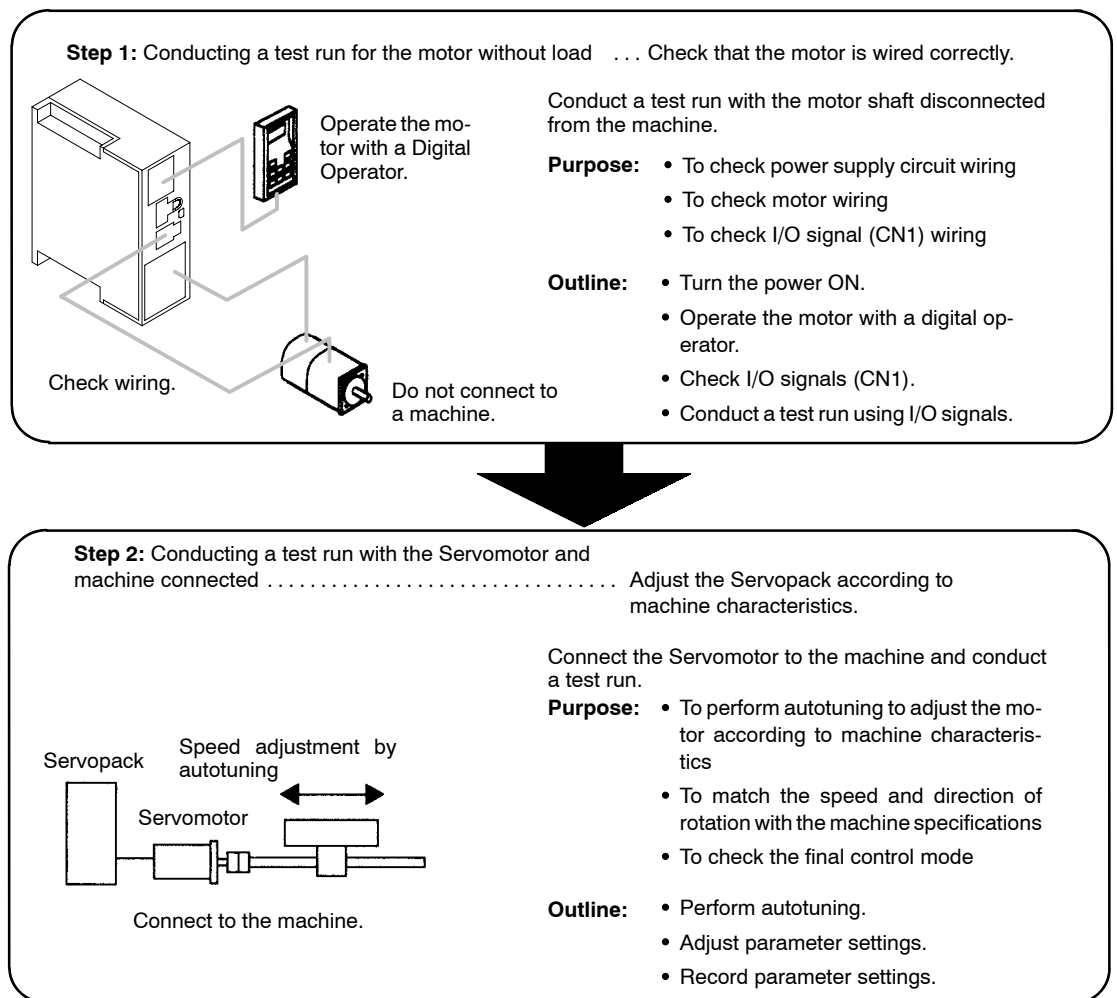

When using a Servomotor with a brake, refer to *1.4.4 Supplementary Information on Test Run* before starting a test run.

1.4.2 Step 1: Test Run for Servomotor without Load

Check that the Servomotor is wired correctly. If the motor fails to rotate properly during a Servo Drive test run, the cause is usually incorrect wiring. Conduct a test run for the motor without a load according to the procedure described below.

Secure the Servomotor.

Secure the Servomotor to the mounting surface to prevent it from moving during operation. Always disconnect couplings and belts for step 1 of the test run.

Check the wiring.

Disconnect connector CN1, then check the Servomotor wiring in the power supply circuit. I/O signals (CN1) are not used.

Turn ON the power.

Turn ON the Servopack power. If the Servopack is turned ON normally, the 7-segment display on the Digital Operator will change as shown in the diagram. Power will not be supplied to the Servomotor because the servo is OFF.

Normal display

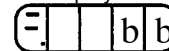

Example of alarm display



If an alarm display appears on the 7-segment display as shown in the diagram above, the power supply circuit, Servomotor wiring, or encoder wiring is incorrect. Turn OFF the power and correct the problem. Refer to *Appendix D List of Alarm Displays* for details.

Operate using the Digital Operator.

Operate the Servomotor with the Digital Operator. Check that the Servomotor runs normally.

Refer to *3.2.2 Operation Using the Digital Operator*.

Connect signal lines.

Connect connector CN1 as follows:

- (1) Turn OFF the power.
- (2) Connect connector CN1.
- (3) Turn ON the power again.

Operation by Digital Operator



If an alarm occurs, the power supply circuit, motor wiring, or encoder wiring is incorrect.

Check input signals.

Using the Digital Operator, check the input signal wiring in monitor mode. For the checking method, refer to 3.1.6 Operation in Monitor Mode.

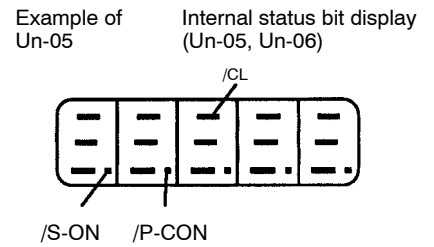

Turn each connected signal line ON and OFF to check that the monitor bit display changes accordingly as shown below.

Input Signal	ON/OFF	Monitor Bit Display
High level or open	OFF	Not lit
0 V level	ON	Lit

If the signal lines below are not wired correctly, the Servomotor fails to rotate. Always wire them correctly. (If signal lines are not to be used, short them as necessary.) The signal lines can be shorted externally by setting the memory switch.

Signal Symbol	Connector Pin No.	Description
/S-ON	CN1-1	Servo is turned ON when this input signal is at 0 V. However, leave the servo in OFF status.

Turn ON servo (motor).

Turn ON the servo as follows:

Check that no reference has been input.

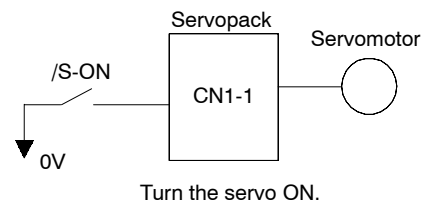

- Speed/torque control: V-REF and T-REF are at 0 V.
- Position control: PULS and SIGN are fixed.

Set /S-ON to 0 V. If normal, the motor is turned ON and the Digital Operator displays the data as shown in the figure. If an alarm display appears, take appropriate action as described in Appendix D List of Alarm Displays.

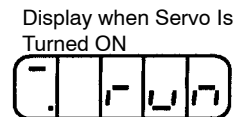

Operate by reference input.

The operating procedure differs according to the Servopack control mode used.

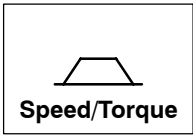

Servopack for Speed/Torque Control

This section describes the standard speed control setting.

- (1) Gradually increase the speed reference input (V-REF, CN1-12) voltage. The Servomotor will rotate.

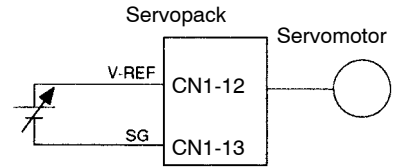

Servomotor rotates at a speed proportional to the reference voltage.

When a host controller such as a Programmable Controller performs position control, it may be difficult to directly input the speed reference voltage. In this case, constant voltage reference should be input once to ensure correct operation.

- (2) Check the following items in monitor mode. Refer to 3.1.6 Operation in Monitor Mode for details.

Un-00	Actual motor speed
Un-01	Reference speed

- Has a reference speed been input?
 - Is the motor speed as set?
 - Does the reference speed match the actual Servomotor speed?
 - Does the Servomotor stop when no reference is input?
- (3) If the motor rotates at an extremely slow speed when 0 V is specified as the reference voltage, correct the reference offset value as described in 3.2.4 Reference Offset Automatic Adjustment.
 - (4) To change the Servomotor speed or the direction of rotation, reset the parameters shown below.

Cn-03	Speed reference gain Refer to 2.2.1 Speed References.
Cn-02 bit 0	Reverse rotation mode Refer to 2.1.1 Switching Motor Rotation Direction.

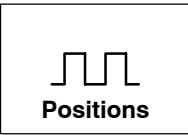

Servopack for Position Control

- (1) Set parameter Cn-02 so that the reference pulse form matches the host controller output form. Refer to 2.2.2 *Position References* for details on how to select reference pulse forms.)

Selecting reference pulse form

Cn-02	Bit 3
	Bit 4
	Bit 5
	Bit D

- (2) Input slow speed pulses from the host controller and execute low-speed operation.

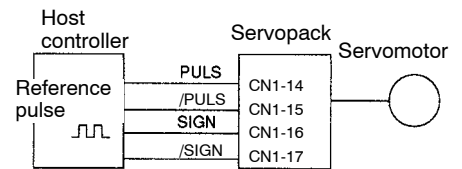

- (3) Check the following items in monitor mode:

Un-00	Actual motor speed
Un-07	Reference pulse speed display
Un-08	Position error

- Has a reference pulse been input?
 - Is the motor speed as set?
 - Does the reference speed match the actual Servomotor speed?
 - Does the Servomotor stop when no reference is input?
- (4) To change motor speed or the direction of rotation, reset the parameters shown below.

Cn-24,Cn-25	Electronic gear ratio Refer to 2.2.5 <i>Electronic Gear</i> .
Cn-02 bit 0	Reverse rotation mode Refer to 2.1.1 <i>Switching Motor Rotation Direction</i> .

If an alarm occurs or the Servomotor fails to rotate during the above operation, connector CN1 wiring is incorrect or the parameter settings do not match the host controller specifications. Check the wiring, review the parameter settings, and then repeat step 1.

1.4.3 Step 2: Test Run with the Servomotor Connected to the Machine

Note Before proceeding to step 2, repeat step 1 (conducting a test run for the Servomotor without load) until you are fully satisfied that the test has been completed successfully. Operation faults that arise after the motor is connected to the machine not only damage the machine but may also cause an accident resulting in injury or death. Test all items including parameter settings and wiring as conclusively as possible before completing step 1.

After step 1 is complete, proceed to step 2, in which a test run is conducted with the Servomotor connected to the machine. The purpose of step 2 is to adjust the Servopack according to the machine characteristics.

Conduct a test run according to the procedure described below.

- (1) Check that power is OFF.
Turn OFF the Servopack power.
- (2) Connect the Servomotor to the machine.
Refer to *1.2.2 Installing the Servomotor*.
- (3) Perform autotuning.
Tune the Servopack according to the machine characteristics. Refer to *3.2.3 Autotuning*.
- (4) Operate by reference input.
As in step 1 (conducting a test run for Servomotor without load), perform *Operate by reference input* on page 1-25. Perform tuning with the host controller.
- (5) Set parameters and record the settings.
Set parameters as necessary. Record all the parameter settings for maintenance purposes.

The test run is now completed.

Normally, the machine may generate much friction because of an insufficient running-in period. After a test run is completed, perform adequate running-in.

1.4.4 Supplementary Information on Test Run

In the following cases, always refer to the information described below before starting a test run:

- When using a Servomotor with a brake
- When performing position control from the host controller

Using a Servomotor with Brake

A Servomotor with a brake is used for vertical axes or axes subject to external force. The brake prevents the motor shaft from rotating if it is subjected to an external force or the force of gravity acting on the load when the Servomotor power is OFF.

Servopack uses the brake interlock output (/BK) signal to control holding brake operation for a Servomotor with brake.

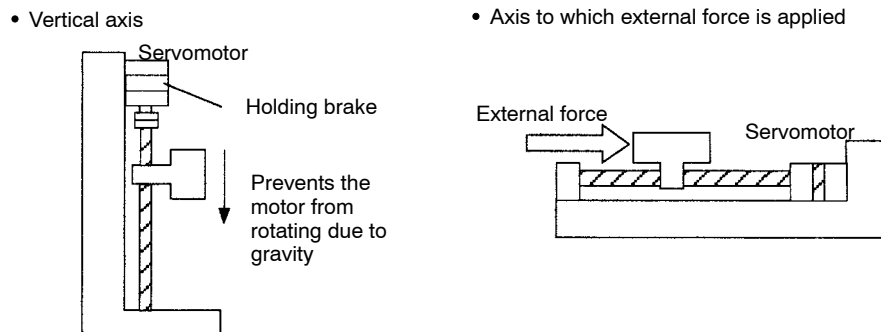

Note To prevent faulty operation caused by gravity (or external force), first check that the Servomotor and holding brake operate normally with the Servomotor disconnected from the machine. If all operations are normal, connect the Servomotor to the machine and conduct a test run.

For wiring of a Servomotor with a brake, refer to *2.4.3 Holding Brake*.

Performing Position Control from the Host Controller

If the position control of the host controller is incomplete, check Servomotor operation and then conduct a test run according to the following table. Always disconnect the Servomotor from the machine before conducting the test run or the Servomotor may run out of control.

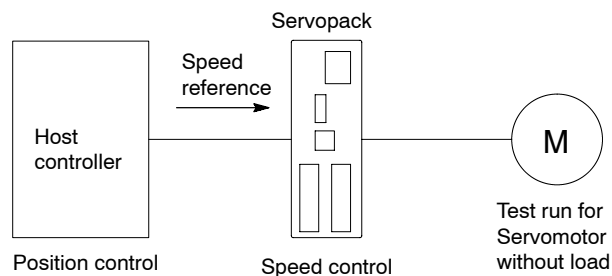

1

Reference from Host Controller	Check Items	Check Method	Review Items
Jogging (constant-speed reference input from host controller)	Motor speed	Check the Servomotor speed as follows: <ul style="list-style-type: none"> • Use the speed monitor (Un-00) of the Digital Operator. • Run the Servomotor at low speed. For example, input a speed reference of 60 min⁻¹ and check that the Servomotor makes one revolution per second. 	Check whether the speed reference gain value (parameter Cn-03) is correct.
Simple positioning	Number of Servomotor revolutions	<ul style="list-style-type: none"> • Input a reference equivalent to one Servomotor revolution and visually check that the Servomotor shaft makes one revolution. 	Check whether the dividing ratio count (parameter Cn-0A) is correct.

1.4.5 Minimum Parameters and Input Signals

Minimum Parameters Required for Test Run

For details on how to set each parameter, refer to 3.1.5 Operation in Parameter Setting Mode.

Servopack for Speed/Torque Control

Cn-03	Speed reference adjustment gain Refer to 2.2.1 Speed References.
Cn-0A	Encoder pulse dividing ratio Refer to 2.2.3 Encoder Output.

Servopack for Position Control

Cn-02 bits 3,4,5	Reference pulse form selection Refer to 2.2.2 Position References.
Cn-02 bit D	Logic of reference pulse Refer to 2.2.2 Position References.
Cn-02 bit F	Reference pulse output form Refer to 2.2.9 Reference Pulse Input Selection Function.
Cn-0A	Encoder pulse dividing ratio Refer to 2.2.3 Encoder Output.
Cn-24	Electronic gear ratio (numerator) Refer to 2.2.5 Electronic Gear.
Cn-25	Electronic gear ratio (denominator) Refer to 2.2.5 Electronic Gear.

After changing the Cn-02 setting, always turn OFF the power, then turn ON again. Turning ON the power again validates the new settings.

Changing Servomotor Rotation Direction

If the specified direction of rotation differs from the actual direction of rotation, the wiring may be incorrect. In this case, recheck the wiring and correct it accordingly. If the direction of rotation is to be reversed, recheck the wiring and set the following parameter:

Cn-02 (bit 0)	Reverse rotation mode Refer to 2.1.1 <i>Switching Motor Rotation Direction</i> .
---------------	---

Minimum Input Signals Required for Test Run

The following table lists the minimum input signals required to conduct a test run.

Signal Name	Pin Number	Function
/S-ON (servo ON)	CN1-1	Switching between motor ON and OFF status. (The memory switch can be used to eliminate the need for external short-circuit wiring.)

This chapter is prepared for readers who have mastered the basic operating procedures and wish to learn more about the applications. It explains how to set parameters for each purpose and how to use each function. Read the applicable sections according to your requirements.

2.1	Setting Parameters According to Machine Characteristics	2-4
2.1.1	Changing Motor Rotation Direction	2-4
2.1.2	Torque Limit	2-5
2.2	Setting Parameters According to Host Controller	2-9
2.2.1	Speed References	2-9
2.2.2	Position References	2-13
2.2.3	Encoder Output	2-17
2.2.4	Contact I/O	2-21
2.2.5	Electronic Gear	2-24
2.2.6	Contact Input Speed Control	2-28
2.2.7	Torque Control	2-32
2.2.8	Reference Pulse Inhibit Function (INHIBIT)	2-36
2.2.9	Reference Pulse Input Filter Selection Function	2-37
2.3	Setting Up the Σ-Series Servopack	2-38
2.3.1	Parameters	2-38
2.3.2	Jog Speed	2-39
2.4	Setting Stop Mode	2-40
2.4.1	Offset Adjustment	2-40
2.4.2	Zero-clamp	2-41
2.4.3	Holding Brake	2-43

- 2.5 Running the Motor Smoothly 2-46**
 - 2.5.1 Soft Start Function 2-46
 - 2.5.2 Smoothing 2-47
 - 2.5.3 Gain Adjustment 2-47
 - 2.5.4 Offset Adjustment 2-48
 - 2.5.5 Torque Reference Filter Time Constant 2-48

- 2.6 Minimizing Positioning Time 2-49**
 - 2.6.1 Autotuning 2-49
 - 2.6.2 Servo Gain 2-49
 - 2.6.3 Feed-forward Control 2-51
 - 2.6.4 Proportional Control 2-51
 - 2.6.5 Setting Speed Bias 2-52
 - 2.6.6 Mode Switch 2-53
 - 2.6.7 Speed Loop Compensation 2-58

- 2.7 Designing a Protective Sequence 2-60**
 - 2.7.1 Servo Alarm Output 2-60
 - 2.7.2 Servo ON Input Signal 2-62
 - 2.7.3 Positioning Complete Output 2-63
 - 2.7.4 Speed Coincidence Output 2-64
 - 2.7.5 Running Output Signal 2-65

- 2.8 Special Wiring 2-67**
 - 2.8.1 Wiring Precautions 2-67
 - 2.8.2 Wiring for Noise Control 2-69
 - 2.8.3 Using More Than One Servo Drive 2-73
 - 2.8.4 Connector Terminal Layouts 2-74

Before Reading this Chapter

This chapter describes how to use each CN1 connector I/O signal for the Servopack and how to set the corresponding parameter.

Refer to the following chapters for further information on areas covered in this chapter.

- For a list of I/O signals, refer to *Appendix B List of I/O Signals*.
- For terminal arrangement for I/O signals, refer to *2.8.4 Connector Terminal Layout*.
- For a list of parameters, refer to *Appendix C List of Parameters*.
- For information on setting parameters, refer to *3.1.5 Operation in Parameter Setting Mode*.

Parameters are divided into the following two types.

Constants	Usage
Memory switches (Cn-01 and Cn-02)	Set each bit to ON or OFF to select a function.
Constant settings (Cn-03 and later)	Set a numerical value such as a torque limit value or speed loop gain.













2.1 Setting Parameters According to Machine Characteristics

This section describes how to set parameters according to the dimensions and performance of the machine to be used.

2.1.1 Changing Motor Rotation Direction

The Servopack provides a reverse rotation mode in which the direction of Servomotor rotation can be reversed without altering the Servomotor wiring. With the standard setting, forward rotation is defined as counterclockwise (ccw) rotation viewed from the drive end.

If reverse rotation mode is used, only the direction of motor rotation will be reversed. The direction (+/-) of axial motion is reversed, but other items remain unchanged.

Reference	Standard Setting	Reverse Rotation Mode
Forward Run Reference	 <p>Encoder output from Servopack (Phase A) PAO  PBO  (Phase B)</p>	 <p>Encoder output from Servopack (Phase A) PAO  PBO  (Phase B)</p>
Reverse Run Reference	 <p>Encoder output from Servopack (Phase A) PAO  PBO  (Phase B)</p>	 <p>Encoder output from Servopack (Phase A) PAO  PBO  (Phase B)</p>

Setting Reverse Rotation Mode

Set bit 0 of memory switch Cn-02 to select reverse rotation mode.

Cn-02 Bit 0	Rotation Direction Selection	Factory Setting: 0	For Speed/Torque Control and Position Control
--------------------	------------------------------	--------------------	---

Set the direction of rotation.

Setting	Meaning
0	Forward rotation is defined as counterclockwise rotation when viewed from the drive end. (Standard setting)
1	Forward rotation is defined as clockwise rotation when viewed from the drive end. (Reverse rotation mode)

2.1.2 Torque Limit

The Servopack can provide the following torque control.

- Level 1: To restrict the maximum output torque to protect the machine or workpiece (internal torque limit)
- Level 2: To restrict torque after the motor moves the machine to a specified position (external torque limit)
- Level 3: To always control output torque, not speed

This section describes how to use levels 1 and 2 of the torque restriction function.

How to Set Level 1: Internal Torque Limit

The maximum torque is restricted to the values set in the following parameters.

Cn-08	TLMTF Forward Rotation Torque Limit	Unit: %	Setting Range: 0 to Maximum Torque	Factory Setting: Maximum Torque	For Speed/Torque Control and Position Control
Cn-09	TLMTR Reverse Rotation Torque Limit	Unit: %	Setting Range: 0 to Maximum Torque	Factory Setting: Maximum Torque	For Speed/Torque Control and Position Control

Sets the maximum torque values for forward rotation and reverse rotation, respectively.

Sets these parameters when torque must be restricted according to machine conditions.

This torque restriction function always monitors torque, and outputs the signal shown on the right when the limit value is reached.

Specifies a torque limit value in terms of a percentage of the rated torque.

Output Signal for Torque Restriction Function

- /CLT
- Status indication mode bit data
- Monitor mode (Un-05) bit 4

Parameter Setting: Cn-2C = 4

Example of Use: Machine Protection

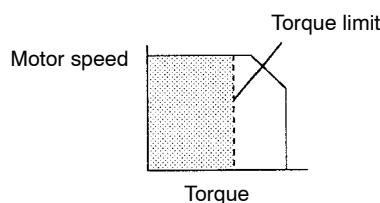

Too small a torque limit value will result in torque shortage at acceleration or deceleration.

Using /CLT Signal

This section describes how to use contact output signal OUT2 as a torque limit output signal.

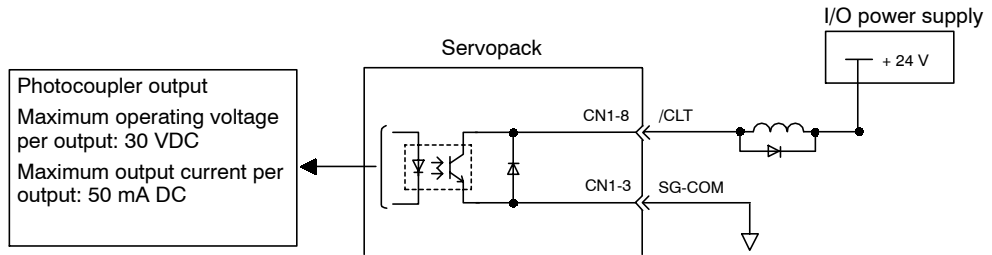

Photocoupler output
Maximum operating voltage per output: 30 VDC
Maximum output current per output: 50 mA DC

Output → /CLT CN1-8	Torque Limit Output	For Speed/Torque Control and Position Control
----------------------------	---------------------	---

This signal indicates whether motor output torque (current) is being restricted.

ON status: The circuit between CN1-8 and CN1-3 is closed. CN1-8 is at low level.	Motor output torque is being restricted. (Internal torque reference is greater than the preset value.) Output torque is restricted to the torque limit value.
OFF status: The circuit between CN1-8 and CN1-3 is open. CN1-8 is at high level.	Motor output torque is not being restricted. (Internal torque reference is equal to or below the preset value.)

Preset Value: Cn-08 (TLMTF)
Cn-09 (TLMTR)
Cn-18 (CLMI) : At /CL input

Note This function is changed to another function depending on the setting of the parameter Cn-2C.

How to Set Level 2: External Torque Limit

First, use a contact input signal to make the torque (current) limit value set in the parameter valid. Torque limit cannot be set separately for forward and reverse rotation.

To use this function, always set bit 2 of memory switch Cn-02 to 0 (standard setting). The contact input speed control function cannot be used.

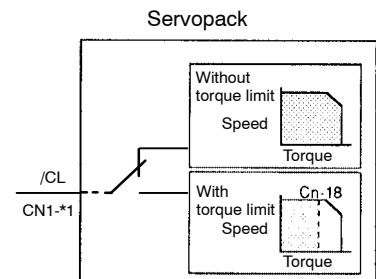

/CL	ON: CN1-*1 is at low level.	Torque is restricted.	Limit value: Cn-18
	OFF: CN1-*1 is at high level.	Torque is not restricted. Normal operation status.	

The torque restriction function outputs the signal shown on the right.

Output Signal for Torque Restriction Function

<ul style="list-style-type: none"> • /CLT • Status indication mode bit data • Monitor mode Un-05 bit 4
Parameter Setting: Cn-2C = 4

Examples of Use:

- Forced stopping
- Holding workpiece by robot

Cn-18	CLMI Forward/Reverse External Torque Limit	Unit: %	Setting Range: 0 to Maximum Torque	Factory Setting: 100	For Speed/Torque Control and Position Control
--------------	--	---------	------------------------------------	----------------------	---

Sets a torque limit value when torque is to be restricted by external contact input.

This function is valid when bit 2 of memory switch Cn-02 is set to 0.

Using /CL Signal

This section describes how to use input signal /CL as torque limit input signals.

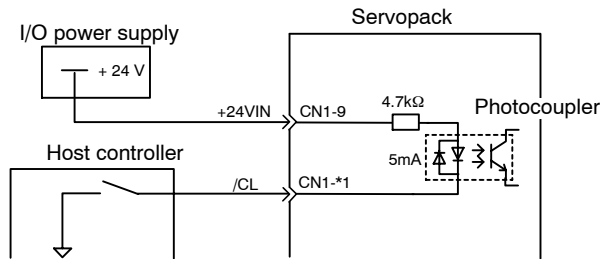

→ Input /CL CN1-*1	Forward/reverse External Torque Limit Input	For Speed/Torque Control and Position Control
---------------------------	---	---

These signals are for forward and reverse external torque (current) limit input.

This function is useful in forced stopping.

The signal shown on the right is output while torque is being restricted.

Output Signal for Torque Restriction Function

<ul style="list-style-type: none"> • /CLT • Status indication mode bit data • Monitor mode Un-05 bit 4
<ul style="list-style-type: none"> • Parameter Setting: Cn-2C = 4

APPLICATIONS

2.1.2 Torque Limit cont.

/CL	ON: CN1-*1 is at low level.	Torque is restricted.	Limit value: Cn-18
	OFF: CN1-*1 is at high level.	Torque is not restricted. Normal operation status.	

Note This function is changed to another function depending on the setting of parameter Cn-2C.

To use input signal /CL as torque limit input signals, set the following parameters.

Cn-2A	Input signal selection 1 (IN1) CN1-1 input signal	Factory Setting: 0	For Speed/Torque Control and Position Control
Cn-2B	Input signal selection 2 (IN2) CN1-2 input signal	Factory Setting: 2	For Speed/Torque Control and Position Control

The function of the input signal changes according to the setting, as shown in the following diagram.

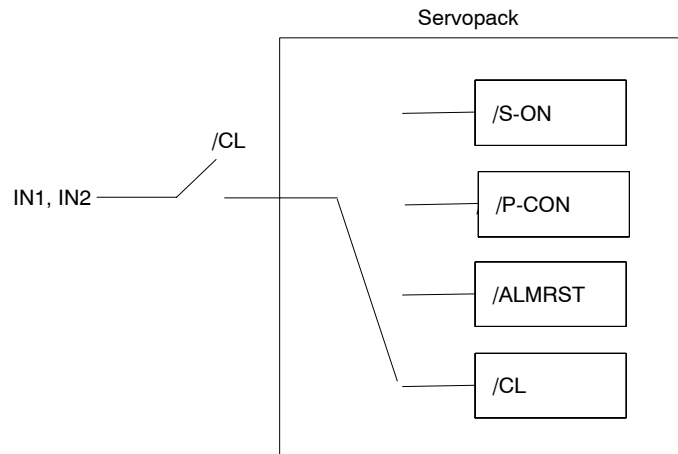

Setting	Meaning
0	/S-ON (Servo ON)
1	/P-CON (proportional control reference)
2	/ALMRST (alarm reset)
3	/CL (torque limit)

2.2 Setting Parameters According to Host Controller

This section describes how to connect a Σ -Series Servo to a host controller and how to set parameters.

2.2.1 Speed References

Input a speed reference by using the following input signal “speed reference input.” Since this signal can be used in different ways, set the optimum reference input for the system to be created.

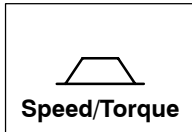
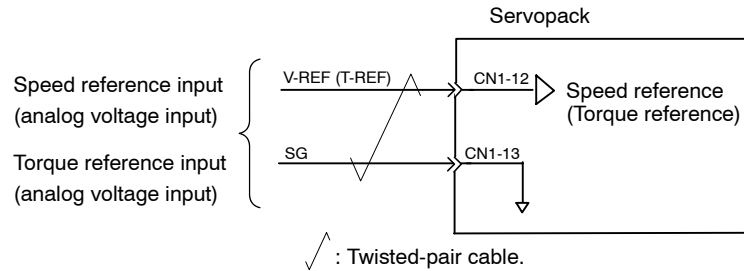

→ Input V-REF CN1-12	Speed Reference Input	For Speed/Torque Control
→ Input SG CN1-13	Signal Ground for Speed Reference Input	For Speed/Torque Control

Use these signals when speed control is selected (bits A and B of memory switch Cn-01).

For ordinary speed control, always wire the V-REF and SG terminals.

Motor speed is controlled in proportion to the input voltage between V-REF and SG.

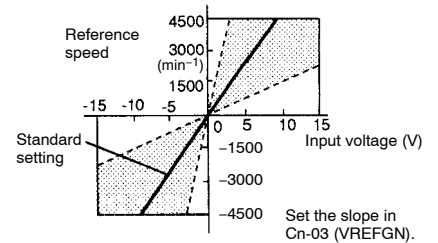

Setting Example

Cn-03 = 500: This setting means that 6 V is equivalent to rated speed (3000 min⁻¹)

Examples:

- +6 V input → 3000 min⁻¹ in forward direction
- +1 V input → 500 min⁻¹ in forward direction
- 3 V input → 1500 min⁻¹ in reverse direction

Parameter Cn-03 can be used to change the voltage input range.

Example of Input Circuit

The adjacent diagram shows an example of an input circuit.

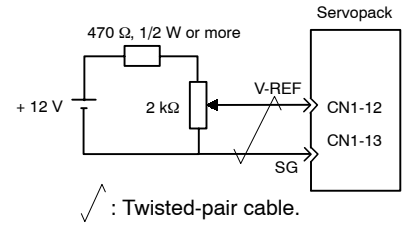

For noise control, always use twisted-pair cable.

Recommended Variable Resistor for Speed Setting:
Type 25HP-10B manufactured by Sakae Tsushin Kogyo Co., Ltd.

When position control is performed by a host controller such as a Programmable Controller, connect V-REF and SG to speed reference output terminals on the host controller. In this case, adjust Cn-03 according to output voltage specifications.

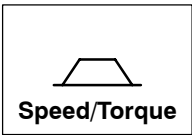
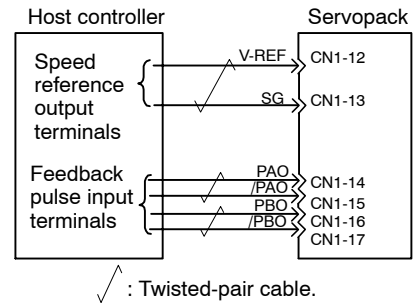

Use the memory switch and input signal /P-CON to specify one of the four modes shown below.

Cn-01 Bit A	Control Mode Selection	Factory Setting: 0	For Speed/Torque Control
Cn-01 Bit B	Control Mode Selection	Factory Setting: 0	For Speed/Torque Control

The Servopack for speed/torque control provides three different control modes.

Cn-01 Setting		Control Mode					
Bit B	Bit A						
0	0	<p>Speed Control</p> <p>This is normal speed control.</p> <ul style="list-style-type: none"> Speed reference is input from V-REF. /P-CON signal is used to switch between P control and PI control. <table border="1"> <tr> <td>CN1-*1 is open</td> <td>PI control</td> </tr> <tr> <td>CN1-*1 is at 0 V</td> <td>P control</td> </tr> </table> <ul style="list-style-type: none"> Torque reference input T-REF cannot be used. 	CN1-*1 is open	PI control	CN1-*1 is at 0 V	P control	<p>Servopack</p>
CN1-*1 is open	PI control						
CN1-*1 is at 0 V	P control						
0	1	<p>Zero-clamp Speed Control</p> <p>This speed control allows the zero-clamp function to be set when the motor stops.</p> <ul style="list-style-type: none"> Speed reference is input from V-REF. /P-CON signal is used to turn the zero-clamp function ON or OFF. <table border="1"> <tr> <td>CN1-*1 is open</td> <td>Turns zero-clamp function OFF</td> </tr> <tr> <td>CN1-*1 is at 0 V</td> <td>Turns zero-clamp function ON</td> </tr> </table> <ul style="list-style-type: none"> Torque reference input T-REF cannot be used. 	CN1-*1 is open	Turns zero-clamp function OFF	CN1-*1 is at 0 V	Turns zero-clamp function ON	<p>Servopack</p> <p>Zero-clamp is performed when the following two conditions are met: Condition 1: /P-CON is turned ON. Condition 2: Motor speed drops below the preset value. Preset value: Cn-0F (ZCLVL)</p>
CN1-*1 is open	Turns zero-clamp function OFF						
CN1-*1 is at 0 V	Turns zero-clamp function ON						
1	0	Torque control					

For details on torque control, refer to 2.2.7 Torque Control.

Using /P-CON Signal:

→ Input /P-CON CN1-*1	Proportional Control, etc.	For Speed/Torque Control and Position Control
-----------------------	----------------------------	---

The function of input signal /P-CON changes with the memory switch setting.

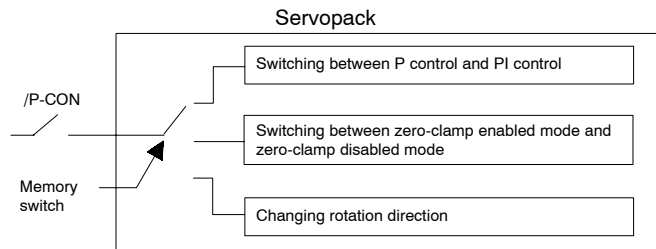

Memory Switch			Meaning of /P-CON Signal
Cn-02 Bit 2	Cn-01 Bit B	Cn-01 Bit A	
0	0	0	Switching between proportional (P) control and proportional/integral (PI) control
0	0	1	Switching between zero-clamp enabled/disabled mode (for speed/torque control only)
0	1	0	Not used (for speed/torque control only)
0	1	1	Not used (do not set)
1	---	---	Changing the direction of rotation during contact input speed control

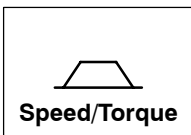

Adjust the speed reference gain using the following parameter.

Cn-03	VREFGN Speed Reference Gain	Unit: (min ⁻¹)/V	Setting Range: 0 to 2162	Factory Setting: 500	For Speed/Torque Control
--------------	-----------------------------	------------------------------	--------------------------	----------------------	--------------------------

This parameter is for speed/torque control only. Sets the voltage range for speed reference input V-REF. Sets this parameter according to the output form of the host controller or external circuit.

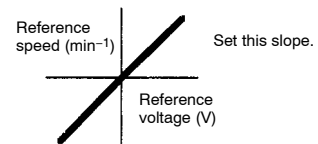

The factory setting is as follows:
 Rated speed (3000 min⁻¹)/6 V = 500



Zero-clamp function

This function is used for a system in which the host controller does not form a position loop. In this case, the stopping position may shift even if a speed reference is set to 0. If the zero-clamp function is turned ON, a position loop is internally formed so that the stopping position is firmly “clamped.”

2.2.2 Position References



Input a position reference by using the following input signal “reference pulse input.” Since there are several specifications for input signal, select reference input for the system to be created.

Pulse Input Reference

Inputs a move reference by pulse input.

Position reference can correspond to the following three types of output form:

- Line driver output
- +12V Open collector output
- +5V Open collector output

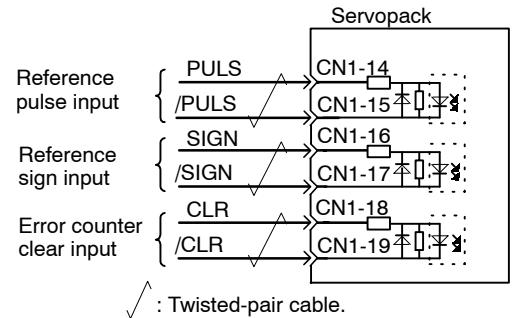

Connection Example 1: Line Driver Output

Line Driver Used:

SN75174 manufactured by Texas Instruments Inc., or MC3487 or equivalent.

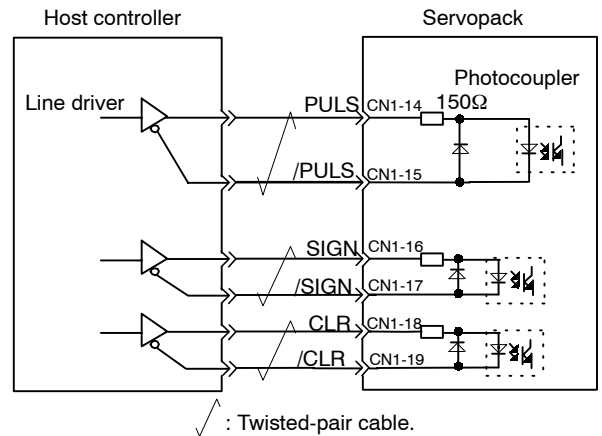

Connection Example 2: Open Collector Output

Sets the value of limiting resistor R1 so that input current i falls within the following range:

Input Current i : 7 to 15 mA

Examples:

- When V_{cc} is 12 V, $R1 = 1\text{ k}\Omega$
- When V_{cc} is 5 V, $R1 = 180\ \Omega$

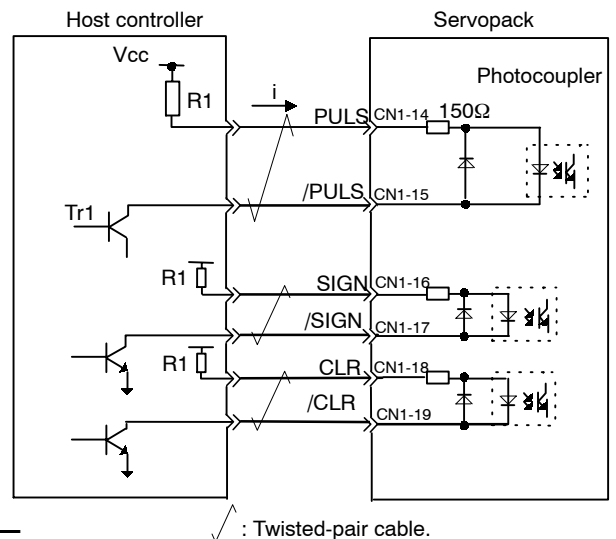

Note The signal logic for open collector output is as follows.

When Tr1 is ON	Equivalent to high level input
When Tr1 is OFF	Equivalent to low level input

Selecting Reference Pulse Form

Use the following memory switches to select the reference pulse form to be used:



→ Input PULS CN1-14	Reference Pulse Input	For Position Control
→ Input /PULS CN1-15	Reference Pulse Input	For Position Control
→ Input SIGN CN1-16	Reference Sign Input	For Position Control
→ Input /SIGN CN1-17	Reference Sign Input	For Position Control

The motor rotates at an angle proportional to the input pulse.

Cn-02 Bit 3	Reference Pulse Form Selection	Factory Setting: 0	For Position Control
Cn-02 Bit 4	Reference Pulse Form Selection	Factory Setting: 0	For Position Control
Cn-02 Bit 5	Reference Pulse Form Selection	Factory Setting: 0	For Position Control





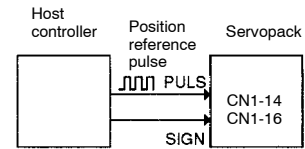

Sets the form of a reference pulse that is externally output to the Servopack.

Sets the pulse form according to the host controller specifications.

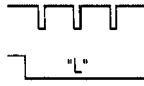
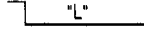
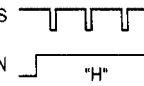
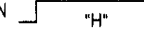
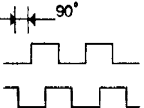

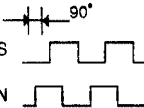
Set also the input pulse logic in bit D of Cn-02.

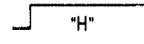
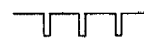
Cn-02				Input Pulse Multiplier	Reference Pulse Form	Motor Forward Run Reference	Motor Reverse Run Reference
Bit D	Bit 5	Bit 4	Bit 3				
0 (Positive logic setting)	0	0	0	/	Sign + pulse train	PULS: [Pulse train] SIGN: "H"	PULS: [Pulse train] SIGN: "L"
	0	1	0	×1	Two-phase pulse train with 90° phase difference	PULS: [90° phase shift] SIGN: [90° phase shift]	PULS: [90° phase shift] SIGN: [90° phase shift]
	0	1	1	×2			
	1	0	0	×4			
	0	0	1	/	CW pulse + CCW pulse	PULS: "L" SIGN: [Pulse train]	PULS: [Pulse train] SIGN: "L"

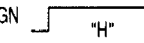
Bit D	Cn-02			Input Pulse Multiplier	Reference Pulse Form	Motor Forward Run Reference	Motor Reverse Run Reference
	Bit 5	Bit 4	Bit 3				
1 (Negative logic setting)	0	0	0	/	Sign + pulse train	PULS  SIGN 	PULS  SIGN 
	0	1	0	×1	Two-phase pulse train with 90° phase difference	PULS  SIGN 	PULS  SIGN 
	0	1	1	×2			
	1	0	0	×4			
	0	0	1	/	CW pulse + CCW pulse	PULS  SIGN 	PULS  SIGN 

Input Pulse Multiply Function:

When the reference form is two-phase pulse train with 90° phase difference, the input pulse multiply function can be used.

The electronic gear function can also be used to convert input pulses.

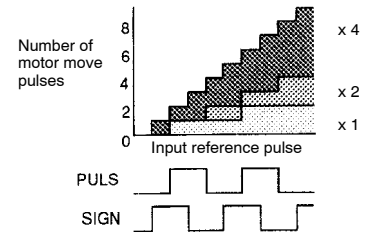

Example of I/O Signal Generation Timing

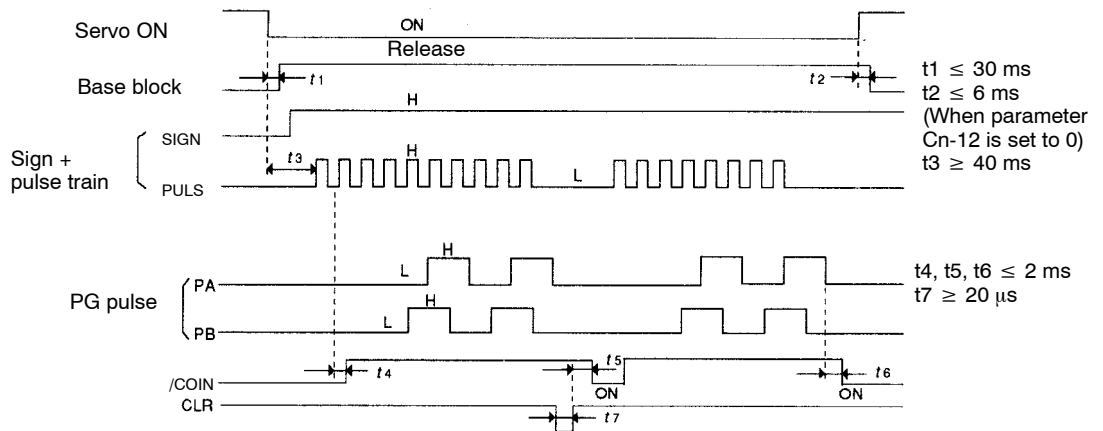

Note (1) The interval from the time the Servo ON signal is turned ON until a reference pulse is input must be at least 40 ms. Otherwise, the reference pulse may not be input.

APPLICATIONS

2.2.2 Position References cont.

- (2) The error counter clear (CLR) signal must be ON for at least 20 μs . Otherwise, it becomes invalid.

Allowable Voltage Level and Timing for Reference Pulse Input

Reference Pulse Form	Electrical Specifications	Remarks
Sign + pulse train input (SIGN + PULS signal) Maximum reference frequency: 450 kpps	<p> $t_1, t_2 \leq 0.1 \mu\text{s}$ $r \geq 1.1 \mu\text{s}$ $t_3, t_7 \leq 0.1 \mu\text{s}$ $t_4, t_5, t_6 > 3 \mu\text{s}$ </p>	The signs for each reference pulse are as follows: ⊕: High level ⊖: Low level
90° different two-phase pulse train (phase A + phase B) Maximum reference frequency x 1 multiplier: 450 kpps x 2 multiplier: 400 kpps x 4 multiplier: 200 kpps	<p> Phase B is 90° forward from phase A Phase B is 90° behind phase A $t_1, t_2 \leq 0.1 \mu\text{s}$ $r \geq 1.1 \mu\text{s}$ $\frac{r}{T} \times 100 \leq 50\%$ </p>	Parameter Cn-02 (bits 3, 4 and 5) is used to switch the input pulse multiplier mode.
CCW pulse + CW pulse Maximum reference frequency: 450 kpps	<p> $t_1, t_2 \leq 0.1 \mu\text{s}$ $r \geq 1.1 \mu\text{s}$ $t_3 > 3 \mu\text{s}$ $\frac{r}{T} \times 100 \leq 50\%$ </p>	

Clearing the Error Counter

Use the following procedure to clear the contents of the error counter.



→ Input CLR CN1-18	Error Counter Clear Input	For Position Control
→ Input /CLR CN1-19	Error Counter Clear Input	For Position Control

Setting the CLR signal to high level will set the following conditions:

- Sets the error counter inside the Servopack to 0.
- Disables position loop control.

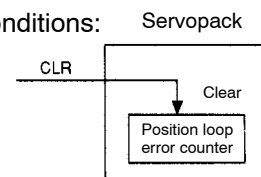

Use this signal to clear the error counter from the host controller.

Bit A of memory switch Cn-02 can be set so that the error counter is cleared only once when the leading edge of an input pulse rises.

Cn-02 Bit A	Error Counter Clear Signal Selection	Factory Setting: 0	For Position Control
--------------------	--------------------------------------	--------------------	----------------------

Selects the pulse form of error counter clear signal CLR.

Setting	Meaning	
0	Clears the error counter when the CLR signal is set at high level. Error pulses do not accumulate while the signal remains at high level.	
1	Clears the error counter only once when the rising edge of the CLR signal rises.	

2.2.3 Encoder Output

Encoder output signals **divided** inside the Servopack can be output externally. These signals can be used to form a position control loop in the host controller.

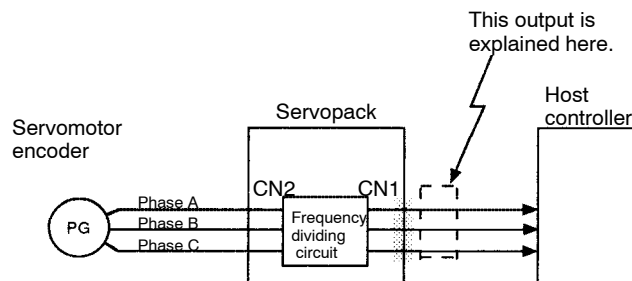

Divided (or dividing)

“Dividing” means converting an input pulse train from the encoder mounted on the motor according to the preset pulse density and outputting the converted pulse. The unit is pulses per revolution.

Speed/Torque Control

The output circuit is for line driver output. Connect each signal line according to the following circuit diagram.

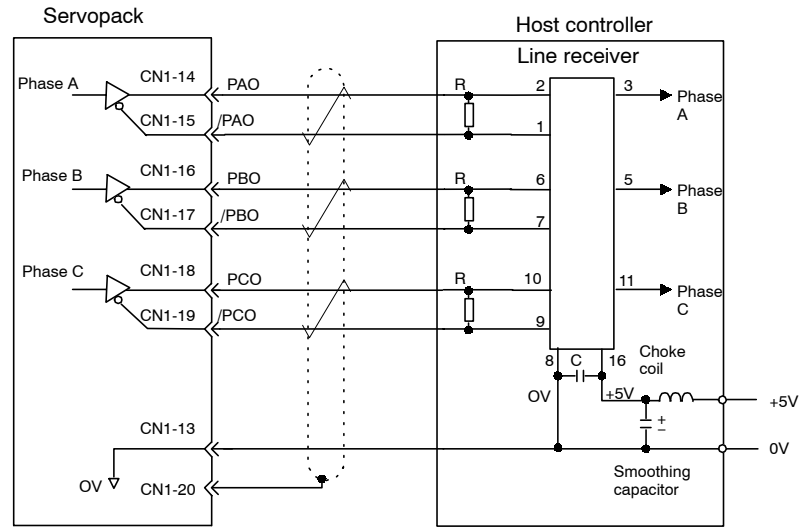

√ : Twisted-pair cable

Line receiver used: SN75175 manufactured by Texas Instruments Inc. or MC3486 (or equivalent)

R (termination resistor): 220 to 470 Ω
 C (decoupling capacitor): 0.1 μF

I/O signals are described below.

Output → PAO CN1-14	Encoder Output Phase A	For Speed/Torque Control
Output → /PAO CN1-15	Encoder Output Phase A	For Speed/Torque Control
Output → PBO CN1-16	Encoder Output Phase B	For Speed/Torque Control
Output → /PBO CN1-17	Encoder Output Phase B	For Speed/Torque Control
Output → PCO CN1-18	Encoder Output Phase C	For Speed/Torque Control
Output → /PCO CN1-19	Encoder Output Phase C	For Speed/Torque Control

Position Control

The output circuit is for open-collector outputs. Connect each signal line according to the following circuit diagram.

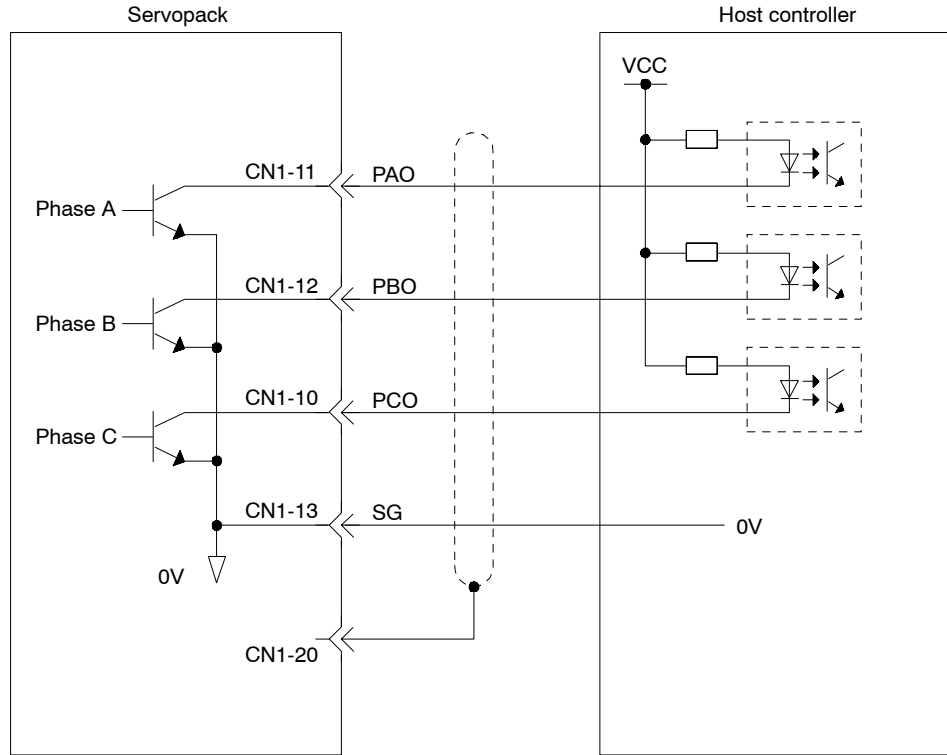

I/O signals are described below.

Output → PAO CN1-11	Encoder Output Phase A	For Position Control
Output → PBO CN1-12	Encoder Output Phase B	For Position Control
Output → PCO CN1-10	Encoder Output Phase C	For Position Control

Divided encoder signals are output.

Always connect these signal terminals when a position loop is formed in the host controller to perform position control.

Set a dividing ratio in the following parameter.

Dividing ratio setting	Cn-0A PGRAT
-------------------------------	-------------

The dividing ratio setting is not relevant to the gear ratio setting (Cn-24, 25) for the electronic gear function of the Servopack for position control.

Output Phase Form

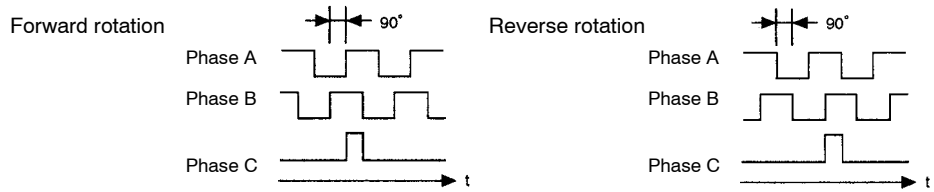

Output → SG CN1-13	Signal Ground for Encoder Output	For Speed/Torque Control and Position Control
Output → FG CN1-20	Frame Ground	For Speed/Torque Control and Position Control

- SG: Connect to 0 V on the host controller.
- FG: Connect to the cable shield wire.

Setting the Pulse Dividing Ratio

Set the pulse dividing ratio in the following parameter.

Cn-0A	PGRAT Dividing Ratio Setting	Unit: P/R	Setting Range: 16 to No. of Encoder Pulses	Factory Setting*: 2048	For Speed/Torque Control and Position Control
--------------	---------------------------------	--------------	--	------------------------------	---

* : 1024 for SGDF-B□C□

Sets the number of output pulses for PG output signals (PAO, /PAO, PBO and /PBO).

Pulses from motor encoder (PG) are divided by the preset number of pulses before being output.

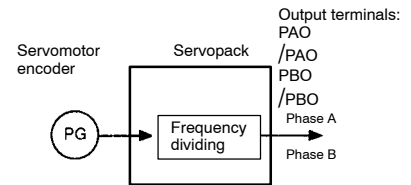

The number of output pulses per revolution is set in this parameter. Set this value according to the reference unit of the machine or controller to be used.

The setting range varies according to the encoder used.

Setting example:

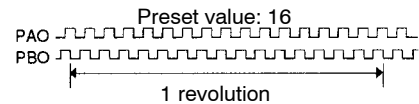

Servopack Type	Encoder	Number of Encoder Pulses Per Revolution	Setting Range
SGDF-A□C□	Incremental encoder	2048 pulses per revolution	16 to 2048
SGDF-B□C□		1024 pulses per revolution	16 to 1024

2.2.4 Contact I/O

Contact I/O are sequence I/O signals used to control Servopack operation. Connect these signal terminals as necessary.

Connecting Contact Input Signals

Connect contact input signal terminal connections as follows:

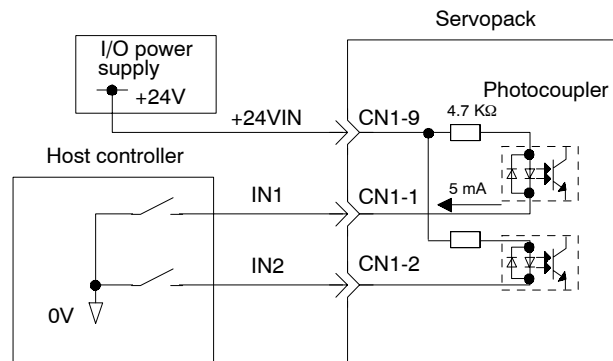

Note Provide an external I/O power supply separately. There are no power terminals to which the Servopack outputs signals externally.

External Power Supply: 24 ± 1 VDC
50 mA or more

Yaskawa recommends that this external power supply be the same type as for the output circuit.

→ Input IN1 CN1-1	Input Signal Selection 1	Factory Setting: 0	For Speed/Torque Control and Position Control
→ Input IN2 CN1-2	Input Signal Selection 2	Factory Setting: 2	For Speed/Torque Control and Position Control

The function of input signal IN1 differs according to the setting of parameter Cn-2A.

The function of input signal IN2 differs according to the setting of parameter Cn-2B.

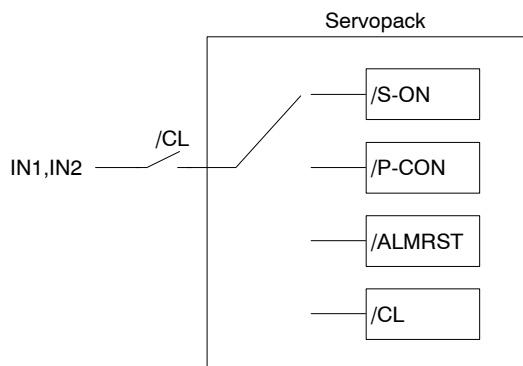

Setting	Meaning
0	/S-ON (Servo ON)
1	/P-CON (proportional control reference)
2	/ALMRST (alarm reset)
3	/CL (torque limit)

→ Input +24VIN CN1-9	External I/O Power Supply	For Speed/Torque Control and Position Control
-----------------------------	---------------------------	---

This external power supply input terminal is common to the following contact input signals:

- Contact Input Signals: /S-ON
/P-CON
/ALMRST
/CL

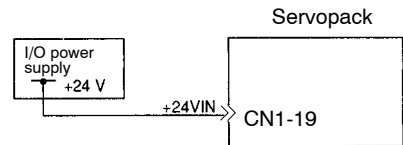

Connect an external I/O power supply.

Contact Output Signal Terminal Connections

Connect contact output signal terminal connections as follows:

These output signals are used to indicate Servopack operation status.

Photocoupler output
Per output
Maximum: operational voltage: 30 VDC
Maximum output current: 50 mA DC

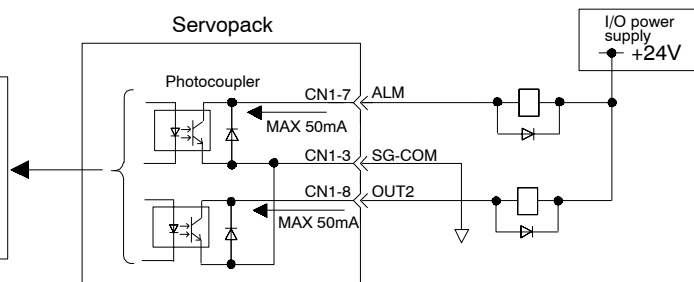

Note Provide an external I/O power supply separately. There are no power terminals to which the Servopack outputs signals externally. Yaskawa recommends that this external power supply be the same type as for the input circuit.

Output → OUT2 CN1-7	Output Signal Selection 2	Factory Setting: 3	For Speed/Torque Control and Position Control
----------------------------	---------------------------	--------------------	---

The function of output signal OUT2 differs according to the setting of parameter Cn-2C.

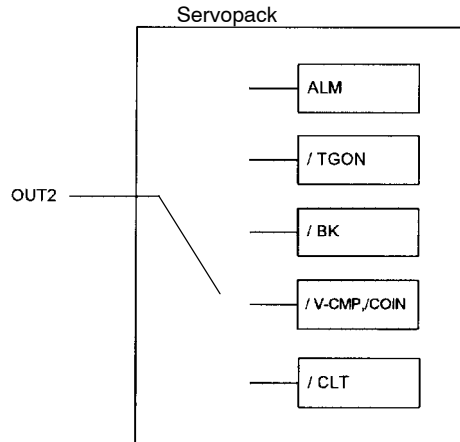

Setting	Meaning
0	ALM (alarm output)
1	/TGON (rotation detection)
2	/BK (brake interlock output)
3	/V-CMP (speed coincidence output for speed/torque control) /COIN (positioning completed signal for positioning control)
4	/CLT (torque limit detection output)

Output → SG-COM CN1-3

Output Signal Ground
Common

For Speed/Torque
Control and
Position Control

This signal ground is used for the following output signals. Connect to 0 V on the external power supply.

Contact Output Signals: ALM
/TGON
/BK
/V-CMP (for speed/torque control only)
/COIN (for position control only)
/CLT

2.2.5 Electronic Gear

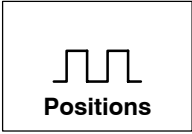

The electronic gear function enables the motor travel distance per input reference pulse to be set to any value. It allows the host controller to perform control without having to consider the machine gear ratio and the number of encoder pulses.

When Electronic Gear Function is Not Used

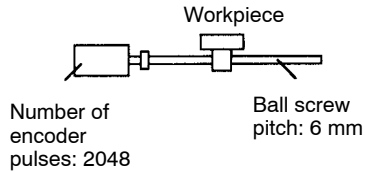

To move a workpiece 10 mm,

One revolution is equivalent to 6 mm, so
 $10 \div 6 = 1.6666$ (revolutions)
 2048 x 4 (pulses) is equivalent to one revolution, so
 $1.6666 \times 2048 \times 4 = 13653$ (pulses)
 A total of 13653 pulses must be input as a reference.
 the host controller needs to make this calculation.

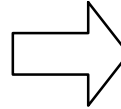

When Electronic Gear Function is Used

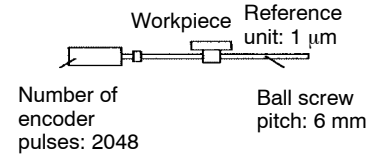

Machine conditions and reference unit must be defined for the electronic gear function beforehand.

To move a workpiece 10 mm:
 Reference unit is 1 μm, so
 $10 \text{ mm} \div 1 \mu\text{m} = 10,000$ pulses

Setting the Electronic Gear

Calculate the electronic gear ratio (B/A) according to the procedure below and set the value in Cn-24 and Cn-25.

- 1) Check the machine specifications.

Items related to electronic gear:

- Gear ratio
- Ball screw pitch
- Pulley diameter

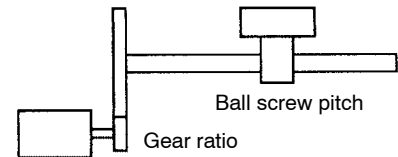

- 2) Check the number of encoder pulses for the Servomotor.

Motor Model	Encoder Type	Number of Encoder Pulses Per Revolution
SGMM-A□C31□	Incremental encoder	2048
SGMM-B□CF1□		1024

Same as parameter Cn-11 settings.

3) Determine the reference unit to be used.

Reference unit is the minimum unit of position data used for moving the load.
(Minimum unit of reference from host controller)

Examples:
0.01 mm, 0.001 mm, 0.1°, 0.01 inch

Reference input of one pulse moves the load by one reference unit.

Example: When reference unit is 1 μm
If a reference of 50,000 pulses is input, the load moves 50 mm (50,000 x 1 μm).

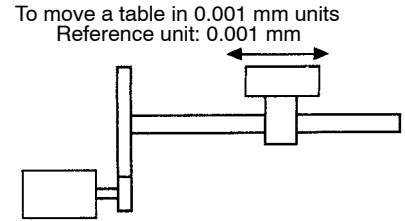

Determine the reference unit according to machine specifications and positioning accuracy.

4) Determine the load travel distance per revolution of load shaft in reference units.

Load travel distance per revolution of load shaft (in reference units)

$$= \frac{\text{Load travel distance per revolution of load shaft (in unit of distance)}}{\text{Reference unit}}$$

Example: When ball screw pitch is 5 mm and reference unit is 0.001 mm
5/0.001 = 5000 (reference units)

Ball Screw	Disc Table	Belt & Pulley
<p>1 revolution $\frac{P}{\text{Reference unit}}$</p>	<p>1 revolution $\frac{360^\circ}{\text{Reference unit}}$</p>	<p>1 revolution $\frac{\pi D}{\text{Reference unit}}$</p>

5) Determine the electronic gear ratio $\left(\frac{B}{A}\right)$.

If the load shaft makes “n” revolutions when the motor shaft makes “m” revolutions, the gear ratio of motor shaft and load shaft is $\frac{n}{m}$.

$$\text{Electronic gear ratio } \left(\frac{B}{A}\right) = \frac{\text{Number of encoder pulses} \times 4}{\text{Travel distance per revolution of load shaft (in reference units)}} \times \frac{m}{n}$$

Note Check that the electronic gear ratio meets the following condition:

$$0.01 \leq \text{Electronic gear ratio } \left(\frac{B}{A}\right) \leq 100$$

If the electronic gear ratio is outside this range, the Servopack will not work properly. In this case, modify the load configuration or reference unit.

6) Set the electronic gear ratio in the parameters below.

Reduce the electronic gear ratio $\left(\frac{B}{A}\right)$ to their lowest terms so that both A and B are an integer smaller than 65535, then set A and B in the following parameters.

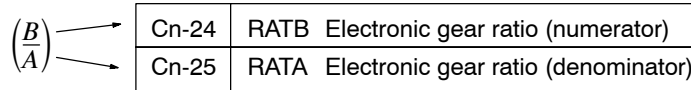

Cn-24	RATB Electronic Gear Ratio Numerator	Unit: None	Setting Range: 1 to 65535	Factory Setting: 4	For Position Control
Cn-25	RATA Electronic Gear Ratio Denominator	Unit: None	Setting Range: 1 to 65535	Factory Setting: 1	For Position Control

These parameters are for position control only.

Set the electronic gear ratio according to machine specifications.

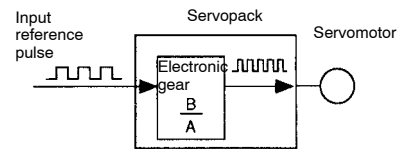

$$\text{Electronic gear ratio } \left(\frac{B}{A}\right) = \frac{\text{Cn-24}}{\text{Cn-25}}$$

$$B = [(\text{Number of encoder pulses}) \times 4] \times [\text{Motor shaft rotating speed}]$$

$$A = [\text{Reference unit (load travel distance per revolution of load shaft)}] \times [\text{Load shaft rotating speed}]$$

The parameter settings must meet the following condition:

$$0.01 \leq \left(\frac{B}{A}\right) \leq 100$$

The electronic gear settings are now complete.

Electronic Gear Setting Examples

Examples of setting an electronic gear ratio for different load mechanisms are shown here.

Ball Screw

Reference unit: 0.001 mm

$$\text{Travel distance per revolution of load shaft} = \frac{6\text{mm}}{0.001\text{mm}} = 6000$$

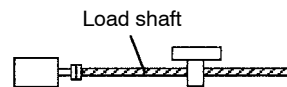

Incremental encoder:
2048 pulses per revolution

Ball screw pitch: 6 mm

$$\text{Electronic gear ratio } \left(\frac{B}{A}\right) = \frac{2048 \times 4 \times 1}{6000 \times 1} = \frac{Cn-24}{Cn-25}$$

Preset values	Cn-24	8192
	Cn-25	6000

Disc Table

Reference unit:
0.1°

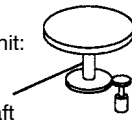

Incremental encoder:
2048 pulses per revolution

Gear ratio:
3 : 1

$$\text{Travel distance per revolution of load shaft} = \frac{360^\circ}{0.1^\circ} = 3600$$

$$\text{Electronic gear ratio } \left(\frac{B}{A}\right) = \frac{2048 \times 4 \times 3}{3600 \times 1} = \frac{Cn-24}{Cn-25}$$

Preset values	Cn-24	24576
	Cn-25	3600

Belt & Pulley

Reference unit: 0.0254 mm
Load shaft

$$\text{Travel distance per revolution of load shaft} = \frac{3.14 \times 100\text{mm}}{0.0254\text{mm}} = 12362$$

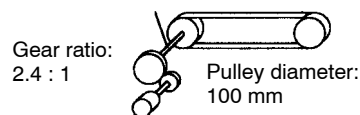

Gear ratio:
2.4 : 1

Pulley diameter:
100 mm

Encoder:
1024 pulses per revolution

$$\text{Electronic gear ratio } \left(\frac{B}{A}\right) = \frac{1024 \times 4 \times 2.4}{12362 \times 1} = \frac{Cn-24}{Cn-25}$$

$$= \frac{9830.4}{12362} = \frac{49152}{61810}$$

Preset values	Cn-24	49152
	Cn-25	61810

Control Block Diagram

A control block diagram for a Servopack used for position control is shown here.

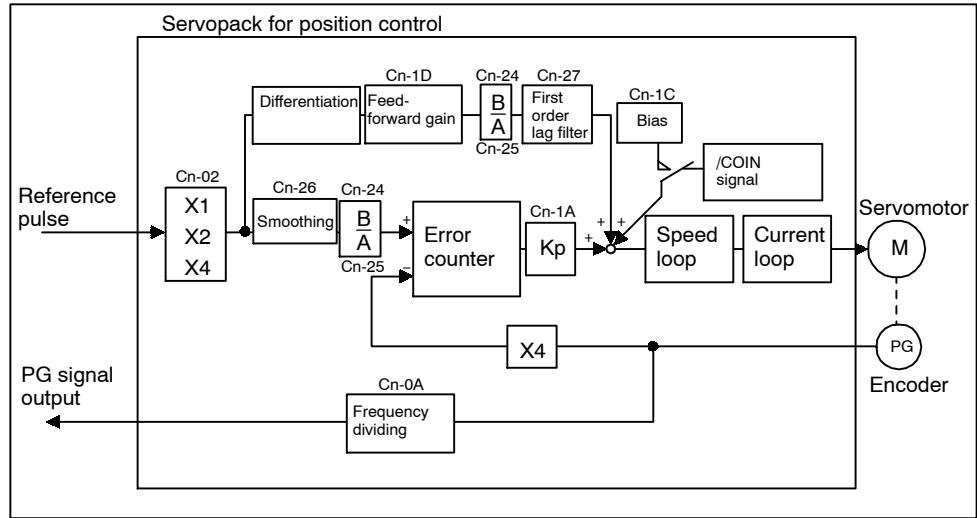

2.2.6 Contact Input Speed Control

The contact input speed control function provides easy-to-use speed control. It allows the user to initially set three different motor speeds in parameters, select one of the speeds externally by contact input and run the motor.

This function can be used for speed/torque control only.

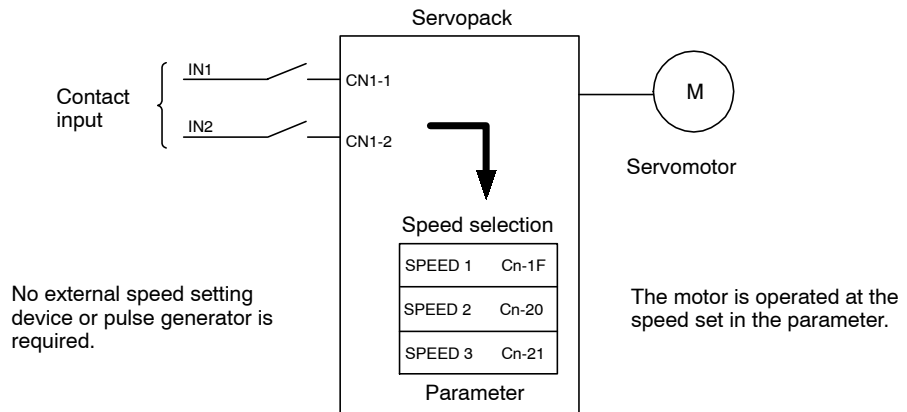

Using Contact Input Speed Control

To use the contact input speed control function, perform the following settings.

- 1) Set the following memory switch to 1.

Cn-02 Bit 2	Contact Input Speed Control Selection (1: Enable, 0: Disable)	Factory Setting: 0	For Speed/Torque Control
--------------------	--	--------------------	--------------------------

The contact input speed control function will be enabled.

If the contact input speed control function is used, the contents of the input signals shown below will change.

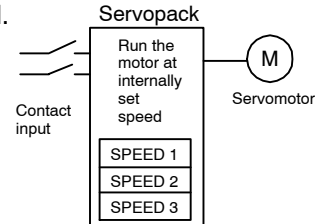

Setting	Meaning	Input Signal															
0	Does not use the contact input speed control function.	<table border="1"> <tr> <td>IN1 (CN1-1)</td> <td>Set in Cn-2A</td> </tr> <tr> <td>IN2 (CN1-2)</td> <td>Set in Cn-2B</td> </tr> </table>	IN1 (CN1-1)	Set in Cn-2A	IN2 (CN1-2)	Set in Cn-2B											
IN1 (CN1-1)	Set in Cn-2A																
IN2 (CN1-2)	Set in Cn-2B																
1	Uses the contact input speed control function. IN1 and IN2 will become contact input speed control signals automatically regardless of CN-2B and Cn-2C settings.	<p style="text-align: right;">0: OFF, 1: ON</p> <table border="1"> <thead> <tr> <th>IN1</th> <th>IN2</th> <th>Speed Setting</th> </tr> </thead> <tbody> <tr> <td>0</td> <td>0</td> <td>Stop (or analog speed reference)</td> </tr> <tr> <td>0</td> <td>1</td> <td>Cn-1F, SPEED1</td> </tr> <tr> <td>1</td> <td>1</td> <td>Cn-20, SPEED2</td> </tr> <tr> <td>1</td> <td>0</td> <td>Cn-21, SPEED3</td> </tr> </tbody> </table>	IN1	IN2	Speed Setting	0	0	Stop (or analog speed reference)	0	1	Cn-1F, SPEED1	1	1	Cn-20, SPEED2	1	0	Cn-21, SPEED3
IN1	IN2	Speed Setting															
0	0	Stop (or analog speed reference)															
0	1	Cn-1F, SPEED1															
1	1	Cn-20, SPEED2															
1	0	Cn-21, SPEED3															

- 2) Set three motor speeds in the following parameters.

Cn-1F	SPEED1 1st Speed (Contact Input Speed Control)	Unit: min ⁻¹	Setting Range: 0 to Maximum Speed	Factory Setting: 100	For Speed/Torque Control
Cn-20	SPEED2 2nd Speed (Contact Input Speed Control)	Unit: min ⁻¹	Setting Range: 0 to Maximum Speed	Factory Setting: 200	For Speed/Torque Control
Cn-21	SPEED3 3rd Speed (Contact Input Speed Control)	Unit: min ⁻¹	Setting Range: 0 to Maximum Speed	Factory Setting: 300	For Speed/Torque Control

Use these parameters to set motor speeds when the contact input speed control function is used (set bit 2 of memory switch Cn-02).

Speed selection input signals IN1 and IN2 enable the motor to run at the preset speeds.

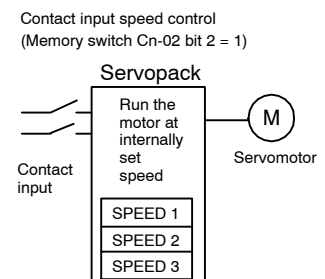

3) Set the rotation direction of the motor.

Cn-02 Bit 3	SPEED1 Rotation Direction	Factory Setting: 0	For Speed/Torque Control
Cn-02 Bit 4	SPEED2 Rotation Direction	Factory Setting: 0	For Speed/Torque Control
Cn-02 Bit 5	SPEED3 Rotation Direction	Factory Setting: 0	For Speed/Torque Control

Set the Servomotor rotation direction settings according to the following table.

Cn-02 Bit 3, Bit 4, and Bit 5	Meaning
0	Sets forward rotation
1	Sets reverse rotation

4) Set the soft start time.

Cn-07	SFSACC Soft Start Time (Acceleration)	Unit: ms	Setting Range: 0 to 10000	Factory Setting: 0	For Speed/Torque Control
Cn-23	SFSDEC Soft Start Time (Deceleration)	Unit: ms	Setting Range: 0 to 10000	Factory Setting: 0	For Speed/Torque Control

In the Servopack, a speed reference is multiplied by the preset acceleration or deceleration value to provide speed control.

When a progressive speed reference is input or contact input speed control is used, smooth speed control can be performed. (For normal speed control, set "0" in each parameter.)

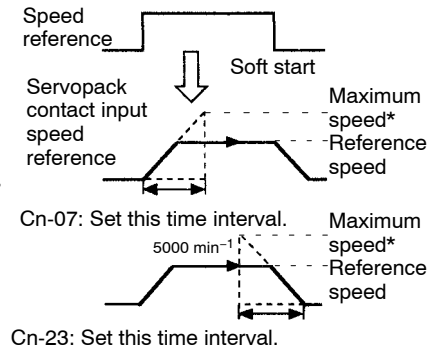

Set the following value in each parameter.

- Cn-07: Time interval from the time the motor starts until it reaches the maximum speed*
- Cn-23: Time interval from the time the motor is running at the maximum speed* until it stops

* : The maximum speed
 SGMM-A□: 5000 min⁻¹
 SGMM-B□: 6000 min⁻¹

Contact Input Speed Control Operation

Contact input speed control performs the following operation.

The following input signals are used to start and stop the motor.

→ Input IN1 CN1-1	Speed Selection 1	For Speed/Torque Control
→ Input IN2 CN1-2	Speed Selection 2	For Speed/Torque Control

Contact Signal		Parameter			Selected Speed	
IN1	IN2	Cn-02	Cn-01			
		Bit 2	Bit A	Bit B		
0	0	1	0	0	Stop	Stopped by internal speed reference 0
			1	0		Stopped by zero-clamp
			0	1	Analog speed reference (V-REF) input	
			1	1	With zero-clamp function	
0	1				SPEED1 (Cn-1F)	
1	1		-----	-----	SPEED2 (Cn-20)	
1	0				SPEED3 (Cn-21)	

Preset values (0 or 1) and input signal status in the portions indicated by horizontal bars (–) are optional.

Set the rotation directions for Cn-1F, Cn-20, and Cn-21 in bits 3, 4, and 5 of Cn-02 respectively.

Note For the speed/torque control type, control by external reference (voltage reference) is possible when the contact input speed control function is used by setting bits A and B of parameter Cn-01.

Contact Input Speed Control Operation Example

The diagram below illustrates an example of operation in contact input speed control mode. Using the soft start function reduces physical shock at speed changeover.

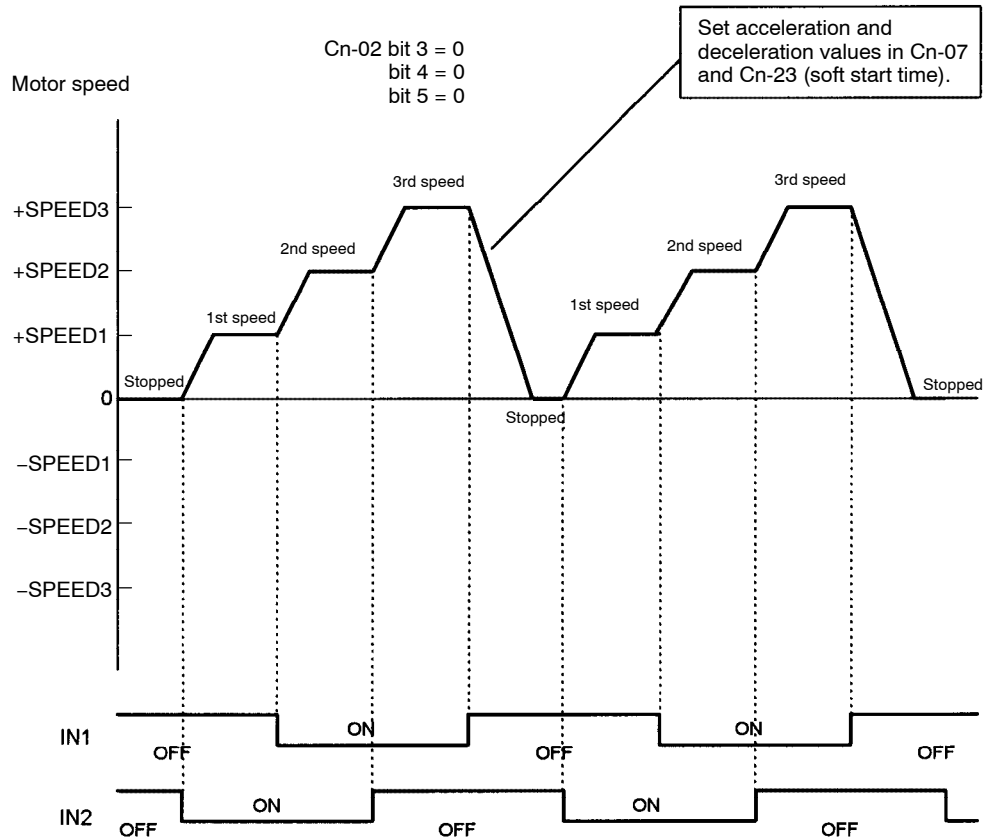

2.2.7 Torque Control

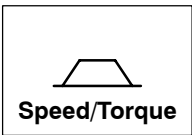

The Servopack can provide the following torque control:

- Level 1: To restrict the maximum output torque to protect the machine or workpiece (internal torque limit)
- Level 2: To restrict torque after the motor moves the machine to a specified position (external torque limit)
- Level 3: To always control output torque, not speed

This section describes how to use level 3 of the torque control function.

Selecting Torque Control

Use the following memory switch to select level 3 (torque control).

Cn-01 Bit A	Control Mode Selection	Factory Setting: 0	For Speed/Torque Control
Cn-01 Bit B	Control Mode Selection	Factory Setting: 0	For Speed/Torque Control

A motor torque reference value is externally input into the Servopack to control torque.

Examples of Use: Tension control
Pressure control

Cn-01 Setting		Control Mode
Bit B	Bit A	
1	0	<p>Torque Control</p> <p>This is a dedicated torque control mode.</p> <ul style="list-style-type: none"> • A torque reference is input from T-REF. • /P-CON is not used. • Speed reference input V-REF cannot be used. • Parameter Cn-14 can be used for maximum speed control. <p>Example of Use:</p> <p style="text-align: right;">Torque reference T-REF (1CN-1) </p>
1	1	Not used (do not set)
0	0	Speed control (standard setting)
0	1	Zero-clamp speed control

Input Signals

The following input signals perform torque control.

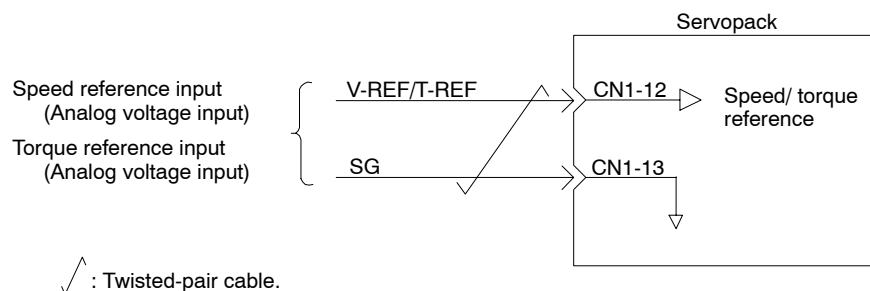

2

→ Input T-REF CN1-12	Torque Reference Input	For Speed/Torque Control
→ Input SG CN1-13	Signal Ground for Torque Reference Input	For Speed/Torque Control

These signals are used when torque control is selected (bits A and B of memory switch Cn-01).

Motor torque is controlled so that it is proportional to the input voltage between T-REF and SG.

Standard Setting

Cn-13 = 30: This setting means that 3 V is equivalent to rated torque.

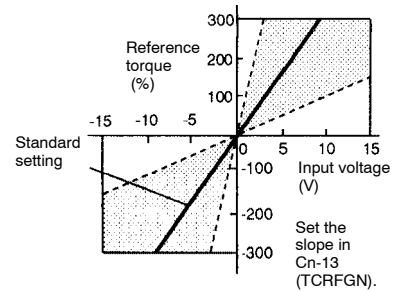

- Examples:
- +3 V input → Rated torque in forward direction
 - +9 V input → 300% of rated torque in forward direction
 - 0.3 V input → 10% of rated torque in reverse direction

Parameter Cn-13 can be used to change the voltage input range.

Example of Input Circuit:
See the figure on the right.

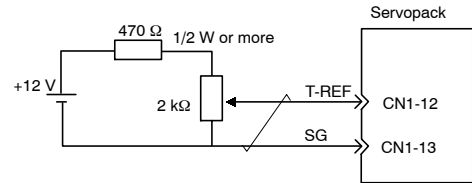

- For noise control, always use twisted-pair cable.
- Example of Variable Resistor for Speed Setting:
Type 25HP-10B manufactured by Sakae Tsushin Kogyo Co., Ltd.

→ Input V-REF CN1-12	Speed Reference Input	For Speed/Torque Control
→ Input SG CN1-13	Signal Ground for Speed Reference Input	For Speed/Torque Control

These signals are used when speed control is selected (bits A and B of memory switch Cn-01).

For normal speed control, always connect these signal terminals.

Motor speed is controlled so that it is proportional to the input voltage between V-REF and SG.

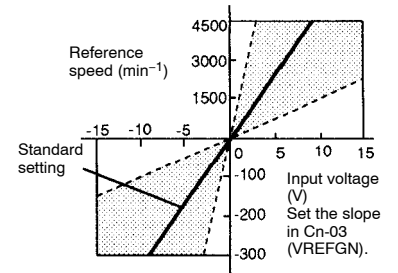

Standard Setting

Cn-03 = 500: This setting means that 6 V is equivalent to rated speed (3000 min⁻¹).

- Examples:
- +6 V input → 3000 min⁻¹ in forward direction
 - +1 V input → 500 min⁻¹ in forward direction
 - 3 V input → 1500 min⁻¹ in reverse direction

Parameter Cn-03 can be used to change the voltage input range. (This is also applicable to speed restriction.)

**Example of Input Circuit:
See the figure on the right.**

- For noise control, always use twisted-pair cable.

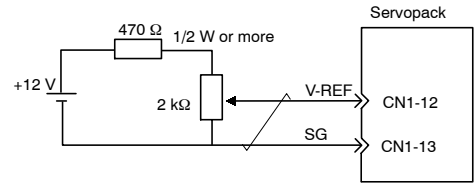

- Example of Variable Resistor for Speed Setting:
Model 25HP-10B manufactured by Sakae Tsushin Kogyo Co., Ltd.

Parameters

Set the following parameters for torque control according to the Servo system used.

Cn-13	TCRFGN Torque Reference Gain	Unit: 0.1 V/Rated Torque	Setting Range: 10 to 100	Factory Setting: 30	For Speed/Torque Control
--------------	---------------------------------	-----------------------------	-----------------------------	------------------------	--------------------------

Sets the voltage range of torque reference input T-REF according to the output form of the host controller or external circuit.

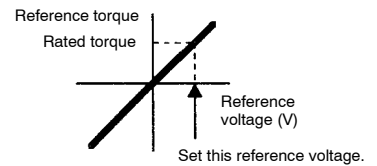

The factory setting is 30, so the rated torque is 3 V (30 x 0.1).

Cn-14	TCRLMT Speed Limit for Torque Control	Unit: min ⁻¹	Setting Range: 0 to Maximum Speed	Factory Setting: Maximum Speed	For Speed/Torque Control Only
--------------	--	----------------------------	-----------------------------------	-----------------------------------	-------------------------------

Sets a motor speed limit value in this constant when torque control is selected.

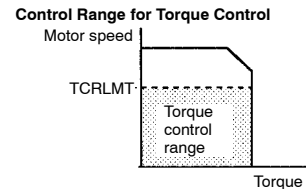

This parameter is used to prevent machine over-speed during torque control.

For torque control, set bits A and B of memory switch Cn-01.

Cn-03	VREFGN Speed Reference Gain	Unit: (min ⁻¹)/V	Setting Range: 0 to 2162	Factory Setting: 500	For Speed/Torque Control
--------------	--------------------------------	---------------------------------	--------------------------	-------------------------	--------------------------

Sets the voltage range of speed reference input V-REF according to the output form of the host controller or external circuit.

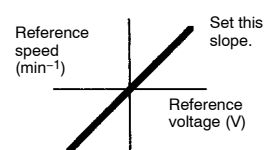

The factory setting is 500 [rated speed (3000 min⁻¹)/6 V = 500].

2.2.8 Reference Pulse Inhibit Function (INHIBIT)



The reference pulse inhibit function inhibits a Servopack for position control from counting input reference pulses.

While this function is being used, the motor remains in Servo locked (clamped) status. The /P-CON signal is used to enable or prohibit this function.

When this function is used, therefore, the /P-CON signal cannot be used to switch between proportion (P) control and proportional/integral (PI) control for speed loop. (PI control is always used.)

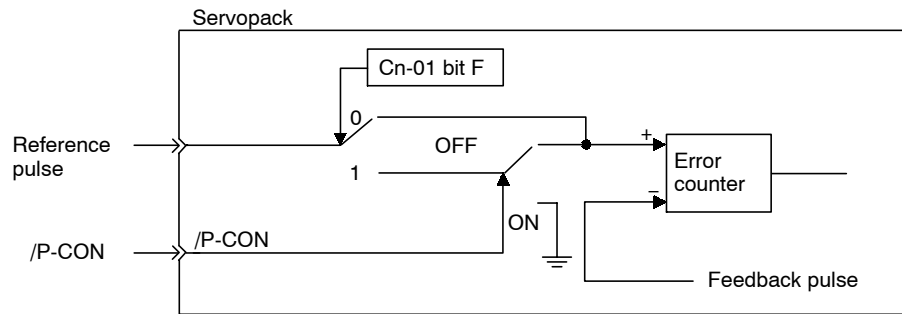

Note Use Cn-01 bit F to enable/disable the INHIBIT function.

Schematic Block Diagram for INHIBIT Function

Using Reference Pulse Inhibit Function (INHIBIT)

To use the INHIBIT function, set the memory switch Cn-01 bit F to 1:



Cn-01 Bit F	Reference Pulse Inhibit Function (INHIBIT) (1: Enable, 0: Disable)	Factory Setting: 0	For Position Control
--------------------	---	--------------------	----------------------

The INHIBIT function will be enabled.

Setting	Meaning						
0	Does not use the INHIBIT function. Reference pulses are always counted.						
1	Uses the INHIBIT function. /P-CON signal is used to enable or prohibit the INHIBIT function.						
	<table border="1"> <thead> <tr> <th>/P-CON</th> <th>Meaning</th> </tr> </thead> <tbody> <tr> <td>OFF</td> <td>Counts reference pulses.</td> </tr> <tr> <td>ON</td> <td>Prohibits the Servopack from counting reference pulses. The motor remains in Servo locked (clamped) status.</td> </tr> </tbody> </table>	/P-CON	Meaning	OFF	Counts reference pulses.	ON	Prohibits the Servopack from counting reference pulses. The motor remains in Servo locked (clamped) status.
	/P-CON	Meaning					
OFF	Counts reference pulses.						
ON	Prohibits the Servopack from counting reference pulses. The motor remains in Servo locked (clamped) status.						

Relationship between INHIBIT Signal and Reference Pulse

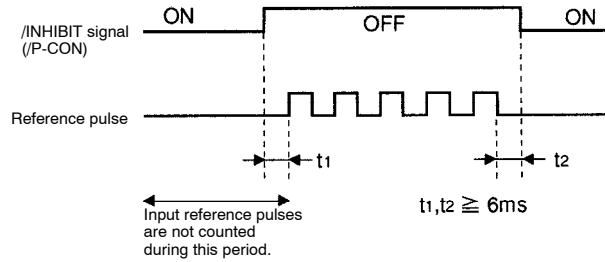

2.2.9 Reference Pulse Input Filter Selection Function



The reference pulse input filter selection function selects a reference pulse input filter inside the Servopack according to the output form of reference pulses from the host controller.

How to Use Reference Pulse Input Filter

Set the following memory switch according to the output form of reference pulses from the host controller:

Cn-02 Bit F	Reference Pulse Input Filter Selection Function	Factory Setting: 0	For Position Control
--------------------	---	--------------------	----------------------

Sets the memory switch according to the output form (line driver or open collector) of reference pulses from the host controller.

Setting	Meaning
0	Output form of reference pulses from host controller: Line driver output (maximum frequency of reference pulse: 450 kpps)
1	Output form of reference pulses from host controller: Open collector output (maximum frequency of reference pulse: 200 kpps)

For open collector output, the wire length must be as short as possible (3 m max.).

Note If a reference greater than 200 kpps is output, the reference pulses may be miscounted due to noise even when the reference pulse is an open-collector output. Miscounting will result in positioning errors. Make sure that wiring is correct and always set memory switch Cn-02 bit F to 0.

2.3 Setting Up the Σ -Series Servopack

■ This section describes how to set parameters to operate the Servopack.

2.3.1 Parameters

Σ -Series Servopacks provide many functions, and have parameters called “parameters” to allow the user to specify each function and perform fine adjustment.

The Digital Operator is used to set parameters.

Parameters are divided into the following two types.

Memory switch Cn-01, Cn-02	Each bit of this switch is turned ON or OFF to specify a function.
Parameter setting Cn-03 and later	A numerical value such as a torque limit value or speed loop gain is set in this constant.

- For Speed/Torque Control:

Parameter	Name and Code		Remarks
Cn-01	Memory switch		} Each bit number has a switch (ON/OFF).
Cn-02	Memory switch		
Cn-03	VREFGN	Speed reference gain	} Parameter setting
Cn-..	
Cn-..	
Cn-2C	OUTS2	Output signal selection 2	

- For Position Control:

Parameter	Name and Code		Remarks
Cn-01	Memory switch		} Each bit number has a switch (ON/OFF).
Cn-02	Memory switch		
Cn-04	LOOPHZ	Speed loop gain	} Parameter setting
Cn-..	
Cn-..	
Cn-2C	OUTS2	Output signal selection 2	

For a list of parameters, refer to *Appendix C List of Parameters*.

Some parameters for speed/torque control and position control have different meanings. Refer to the list of parameters for each type.

For details of how to set parameters, refer to 3.1.5 *Operation in Parameter Setting Mode*.

2.3.2 Jog Speed

Use the following parameter to set or modify a motor speed when operating the Σ -Series Servo from a Digital Operator.

Cn-10	JOGSPD Jog Speed	Unit: min ⁻¹	Setting Range: 0 to Maximum Speed	Factory Setting: 500	For Speed/Torque Control and Position Control
--------------	---------------------	----------------------------	---	----------------------------	---

This constant is used to set a motor speed when the motor is operated using a Digital Operator.

2.4 Setting Stop Mode

■ This section describes how to stop the motor properly.

2.4.1 Offset Adjustment

Why does the motor not stop?

When 0 V is specified as reference voltage for Servopack for speed/torque control, the motor may rotate at a very slow speed and fail to stop. This happens when reference voltage from the host controller or external circuit has a slight reference offset (in mV units). If this offset is adjusted to 0 V, the motor will stop.

When reference voltage from the host controller or external circuit has an offset

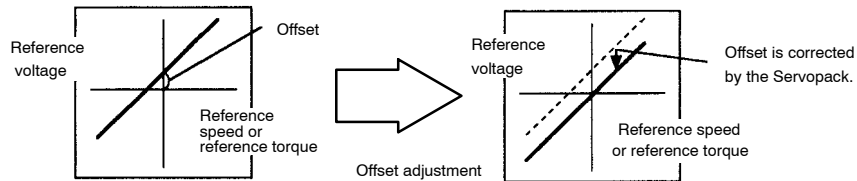

Reference Offset Adjustment

The following two methods can be used to adjust the reference offset to 0 V.

Automatic adjustment of reference offset	Reference offset is automatically adjusted to 0 V.
Manual adjustment of reference offset	Reference offset can be intentionally set to a specified value.

Note If a position control loop is formed in the host controller, do not use automatic adjustment. Always use manual adjustment.

For detailed adjustment procedures, refer to the following sections of *Chapter 3 Using the Digital Operator*.

Adjustment Method	Section
Automatic adjustment of reference offset	3.2.4 Reference Offset Automatic Adjustment Mode.
Manual adjustment of reference offset	3.2.5 Reference Offset Manual Adjustment Mode.

2.4.2 Zero-clamp

What is the Zero-clamp Function?

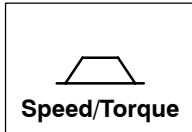

The zero-clamp function is used for a system in which the host controller does not form a position loop by speed reference input.

In other words, this function is used to stop the motor and enter a servo locked status when the input voltage of speed reference V-REF is not 0 V. When the zero-clamp function is turned ON, an internal position loop is temporarily formed, causing the motor to be clamped within one pulse. Even if the motor is forcibly rotated by external force, it returns to the zero-clamp position.

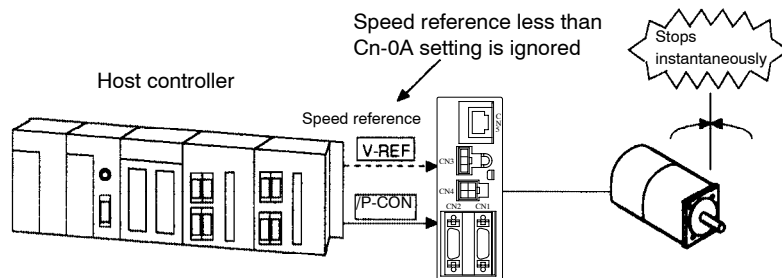

Set the following memory switch so that input signal /P-CON can be used to enable or disable the zero-clamp function.

Cn-01Bit A	Control Mode Selection	Factory Setting:0	For Speed/Torque Control
Cn-01Bit B	Control Mode Selection	Factory Setting:0	For Speed/Torque Control

→ Input /P-CON CN1-*1	Proportional Control, etc.	For Speed/Torque Control and Position Control
------------------------------	----------------------------	---

2

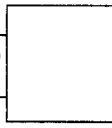
Cn-01 Setting		Control Mode					
Bit B	Bit A						
0	1	<p>Zero-clamp Speed Control This speed control allows the zero-clamp function to be set when the motor stops.</p> <ul style="list-style-type: none"> • A speed reference is input from V-REF. • /P-CON is used to turn the zero-clamp function ON or OFF. <table border="1"> <tr> <td>/P-CON is open (OFF)</td> <td>Turns zero-clamp function OFF</td> </tr> <tr> <td>/P-CON is closed (ON)</td> <td>Turns zero-clamp function ON</td> </tr> </table> <ul style="list-style-type: none"> • Torque reference input T-REF cannot be used. 	/P-CON is open (OFF)	Turns zero-clamp function OFF	/P-CON is closed (ON)	Turns zero-clamp function ON	<p>Servopack</p> <p>Speed reference V-REF (CN1-12)</p> <p>Zero-clamp /P-CON (CN1-1*)</p>  <p>Zero-clamp is performed when the following two conditions are met: /P-CON signal is closed. Motor speed is below the value set in Cn-0F (ZCLVL).</p>
/P-CON is open (OFF)	Turns zero-clamp function OFF						
/P-CON is closed (ON)	Turns zero-clamp function ON						

Settings

Set the motor speed level at which zero-clamp is to be performed in the following parameter.

Cn-0F	ZCLVL Zero-clamp Level	Unit: min ⁻¹	Setting Range: 0 to Maximum Speed	Factory Setting: 10	For Speed/Torque Control

If zero-clamp speed control is selected, set the motor speed level at which zero-clamp is to be performed.

Conditions for Zero-clamp

Zero-clamp is performed when all the following conditions are met:

- Zero-clamp speed control is selected. (Bits A and B of memory switch Cn-01 are set to 1 and 0, respectively.)
- /P-CON is turned ON (0 V).
- Motor speed drops below the preset value.

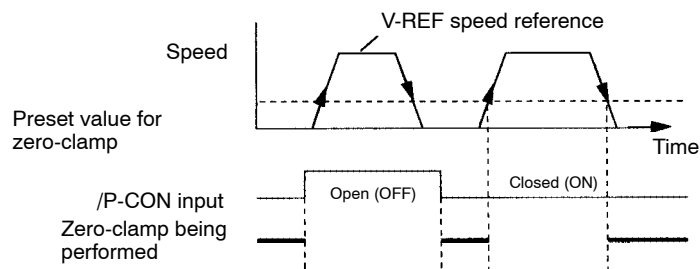

2.4.3 Holding Brake

Holding brake is useful when a Servo Drive is used to control a vertical axis. A Servomotor with brake prevents the movable part from dropping due to gravitation when the system power is turned OFF.

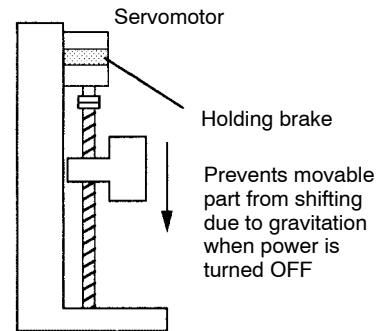

Note The Servomotor with brake has a built-in brake that is a de-energization operation type, which is used for holding purposes only. The brake cannot be used to stop the motor. Use the holding brake only to retain a stopped motor. Brake torque is more than 100% of the rated motor torque.

Connection Examples

Use Servopack contact output-signal /BK and brake power supply to form a brake ON/OFF circuit.

The following diagram shows a standard connection example.

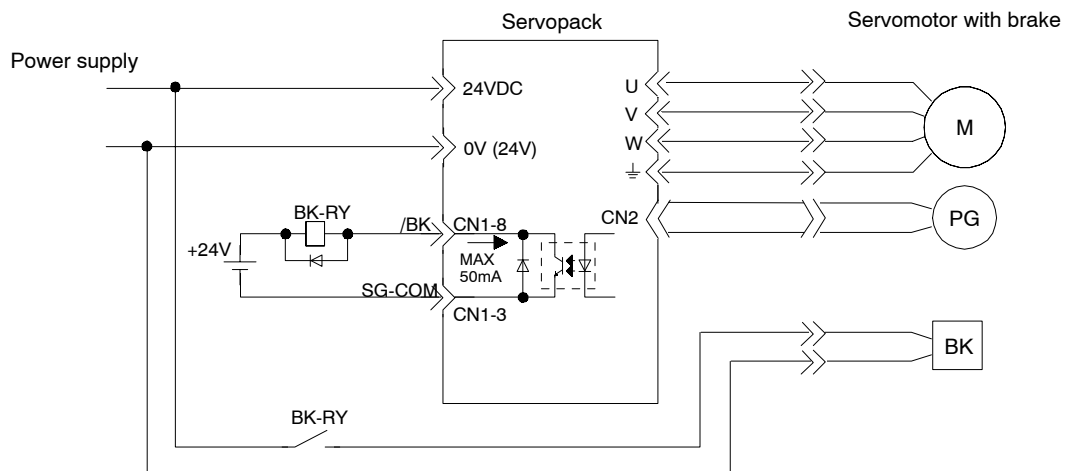

BK-RY: Brake control relay

Output → /BK CN1-8	Brake Interlock Output	For Speed/Torque Control and Position Control
---------------------------	------------------------	---

This output signal controls the brake when a motor with brake is used. This signal terminal need not be connected when a motor without brake is used.

ON Status: Circuit between CN1-8 and CN1-3 is closed. CN1-8 is at low level.	Releases the brake.
OFF Status: Circuit between CN1-8 and CN1-3 is open. CN1-8 is at high level.	Applies the brake.

Related Parameters

Cn-12	Time delay from brake signal until servo OFF
Cn-15	Speed level for brake signal output during operation
Cn-16	Output timing of brake signal during motor operation

Output → SG-COM CN1-3	Output Signal Ground Common	For Speed/Torque Control and Position Control
------------------------------	-----------------------------	---

This is a signal ground for the output signals shown below. Connect this signal terminal to 0 V on the external power supply.

Contact Output Signals: /BK
 /V-CMP (for speed/torque control only)
 /COIN (for position control only)
 /TGON

Brake ON Timing

If the machine moves slightly due to gravity when the brake is applied, set the following parameter to adjust brake ON timing:

Cn-12	BRKTIM	Time delay from the time a brake signal is output until servo OFF status occurs	Unit: 10 ms	Setting Range: 0 to 50	Factory Setting: 0	For Speed/Torque Control and Position Control
--------------	--------	---	----------------	---------------------------	-----------------------	---

This parameter is used to set output timing of brake control signal /BK and servo OFF operation (motor output stop) when a Servomotor with brake is used.

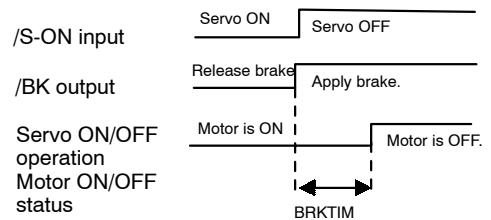

With the standard setting, the servo is turned OFF when /BK signal (brake operation) is output. The machine may move slightly due to gravitation. This movement depends on machine configuration and brake characteristics. If this happens, use this parameter to delay servo OFF timing to prevent the machine from moving.

Set in this constant the brake ON timing used when the motor is in stopped status.

2

For brake ON timing during motor operation, use Cn-15 and Cn-16.

Setting the Holding Brake

Set the following parameters to adjust brake ON timing so that holding brake is applied when the motor stops.

Cn-15	BRKSPD	Speed Level at which Brake Signal Is Output during Motor Operation	Unit: min^{-1}	Setting Range: 0 to Maximum Speed	Factory Setting: 100	For Speed/Torque Control and Position Control
Cn-16	BRKWAI	Output Timing of Brake Signal during Motor Operation	Unit: 10 ms	Setting Range: 10 to 100	Factory Setting: 50	For Speed/Torque Control and Position Control

Cn-15 and Cn-16 are used to set brake timing when the servo is turned OFF by input signal /S-ON or alarm occurrence during motor rotation.

Brakes for Servomotors are designed as holding brakes. Therefore, brake ON timing when the motor stops must be appropriate. Adjust the parameter settings while observing machine operation.

Brake Timing when Motor is in Stopped Status

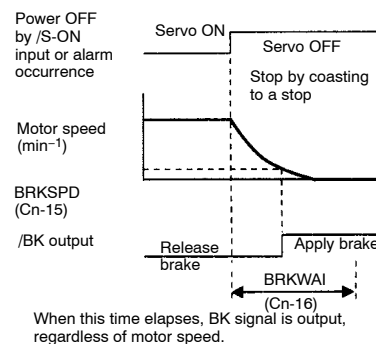

Conditions for /BK Signal Output During Motor Operation

The circuit between CN1-8 and CN1-3 is opened in either of the following situations.

1	Motor speed drops below the value set in Cn-15 (BRKSPD) after servo OFF occurs.
2	The time set in Cn-16 (BRKWAI) has elapsed since servo OFF occurred.

2.5 Running the Motor Smoothly

This section explains how to run the Servomotor smoothly.

2.5.1 Soft Start Function

2

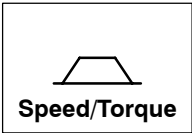

The soft start function adjusts progressive speed reference input inside the Servopack so that acceleration and deceleration can be as constant as possible. To use this function, set the following parameters.

Cn-07	SFSACC Soft Start Time (Acceleration)	Unit: ms	Setting Range: 0 to 10000	Factory Setting: 0	For Speed/Torque Control
Cn-23	SFSDEC Soft Start Time (Deceleration)	Unit: ms	Setting Range: 0 to 10000	Factory Setting: 0	For Speed/Torque Control

In the Servopack, a speed reference is multiplied by the acceleration or deceleration value set in Cn-07 or Cn-23 to provide speed control.

Smooth speed control can be achieved when progressive speed references are input or when contact input speed control is used.

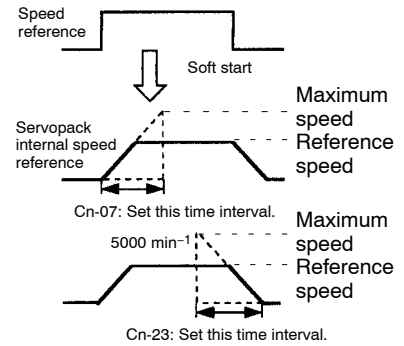

Set these parameters as follows:

Cn-07: Time interval from the time the motor starts until the maximum speed (5000 min⁻¹) is reached.

Cn-23: Time interval from the time the motor is running at the maximum speed (5000 min⁻¹) until it stops.

2.5.2 Smoothing



The smoothing function adjusts constant-frequency reference input inside the Servopack so that acceleration and deceleration can be as constant as possible. To use this function, set the following parameter.

Cn-26	ACCTME	Position Reference Acceleration/Deceleration Time Constant (Smoothing)	Unit: 0.1 ms	Setting Range: 0 to 640	Factory Setting: 0	For Position Control
--------------	--------	--	--------------	-------------------------	--------------------	----------------------

This function performs acceleration/deceleration processing for input reference pulses (primary lag characteristics).

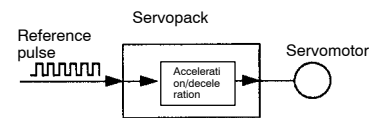

This function prevents the motor from running at progressive speeds in the following cases:

- When the host controller which outputs references cannot perform acceleration/deceleration processing

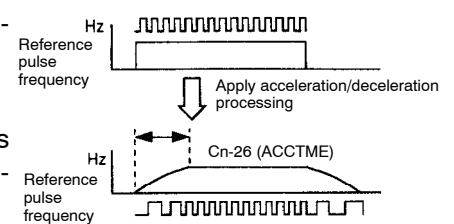

- When reference pulse frequency is too low
- When reference electronic gear ratio is too high (more than 10 times)

This function does not change the travel distance (number of pulses).

2.5.3 Gain Adjustment

If speed loop gain or position loop gain exceeds the allowable limit for the servo system including the machine to be controlled, the system will vibrate or become too susceptible. Under such conditions, smooth operation cannot be expected. Reduce each loop gain value to an appropriate value.

For details on servo gain adjustment, refer to *2.6.2 Servo Gain*.

2.5.4 Offset Adjustment

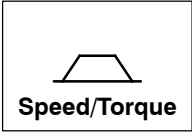

If reference voltage from the host controller or external circuit has an offset in the vicinity of 0 V, smooth operation cannot be expected. Adjust the reference offset to 0 V.

When Reference Voltage from Host Controller or External Circuit has an Offset

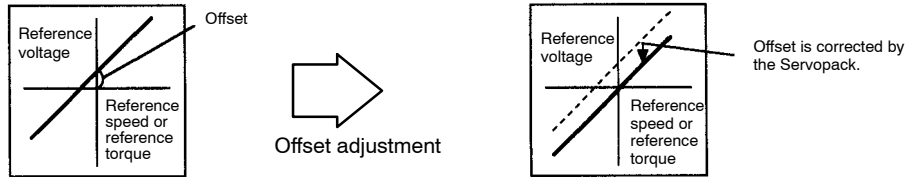

Reference Offset Adjustment

The following two methods are available to adjust the reference offset to 0 V.

Automatic adjustment of reference offset	Reference offset is automatically adjusted.
Manual adjustment of reference offset	Reference offset can be intentionally set to a specified value.

Note If a position control loop is formed in the host controller, do not use automatic adjustment. Always use manual adjustment.

For detailed adjustment procedures, refer to the following sections:

Adjustment Method	Section
Automatic adjustment of reference offset	3.2.4 Reference Offset Automatic Adjustment Mode.
Manual adjustment of reference offset	3.2.5 Speed Reference Offset Manual Adjustment Mode.

2.5.5 Torque Reference Filter Time Constant

If the machine causes vibration, possibly resulting from the Servo Drive, adjust the following filter time constant. Vibration may stop.

Cn-17	TRQFIL Torque Reference Filter Time Constant	Unit: 100 μ s	Setting Range: 0 to 250	Factory Setting: 4	For Speed/Torque Control and Position Control
--------------	--	----------------------	-------------------------------	--------------------------	---

Cn-17 is a torque reference filter time constant for the Servopack. The smaller the value, the higher the torque control response. There is, however, a certain limit depending on machine conditions.

With the standard setting, the machine may cause vibration resulting from the Servo Drive. In this case, increase the constant setting. Vibration may stop. Vibration can be caused by problems such as incorrect gain adjustment and machine malfunction.

2.6 Minimizing Positioning Time

■ This section describes how to minimize positioning time.

2.6.1 Autotuning

If speed loop gain and position loop gain for the servo system are not set properly, positioning may become slow. Techniques and experience are required to set these servo gain values according to machine configuration and machine rigidity.

Σ-Series Servopacks have an autotuning function that automatically measures machine characteristics and sets the necessary servo gain values. With this function, even first-time servo users can easily perform tuning for servo gain. Servo gain values are set in parameters.

The following parameters can be automatically set by the autotuning function.

Parameter	Meaning
Cn-04	Speed loop gain
Cn-05	Speed loop integration time constant
Cn-1A	Position loop gain

For details of how to perform autotuning, refer to *3.2.3 Autotuning*

2.6.2 Servo Gain

Check and reset the servo gain when:

- Automatically set servo gain values need to be checked after autotuning.
- Each servo gain value checked after autotuning is to be directly set for another Servopack.
- Response performance needs to be further enhanced after autotuning, or servo gain values need to be reset for a system with lower response performance.

Setting Speed Loop

Set the following parameters related to speed loop as necessary.

Cn-04	LOOPHZ Speed Loop Gain (Kv)	Unit: Hz	Setting Range: 1 to 2000	Factory Setting: 80	For Speed/Torque Control and Position Control
Cn-05	PITIME Speed Loop Integration Time Constant (Ti)	Unit: ms	Setting Range: 2 to 10000	Factory Setting: 20	For Speed/Torque Control and Position Control

Cn-04 and Cn-05 are a speed loop gain and an integration time constant for the Servopack, respectively.

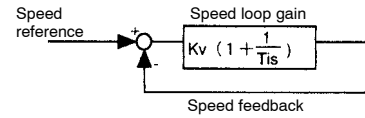

The higher the speed loop gain value or the smaller the speed loop integration time constant value, the higher the speed control response. There is, however, a certain limit depending on machine characteristics.

These parameters are automatically set by the autotuning function.

The unit of speed loop integration time constant Cn-05 (Ti) can be changed to 0.01 ms.

Setting Position Loop

Set the following parameters related to position loop as necessary.

Cn-1A	POSGN Position Loop Gain (Kp)	Unit: 1/s	Setting Range: 1 to 200	Factory Setting: 40	For Speed/Torque Control and Position Control
--------------	----------------------------------	--------------	-------------------------------	---------------------------	---

This parameter is a position loop gain for the Servopack.

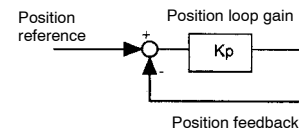

Increasing the position loop gain value provides position control with higher response and less error. However, there is a certain limit depending on machine characteristics.

This parameter is automatically set by the autotuning function.

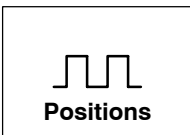

Cn-1E	OVERLV Overflow	Unit: 256 References	Setting Range: 1 to 65536	Factory Setting: 1024	For Position Control
--------------	--------------------	-------------------------	---------------------------------	-----------------------------	----------------------

Set in this parameter the error pulse level at which a position error pulse overflow alarm (alarm A.31) is detected.

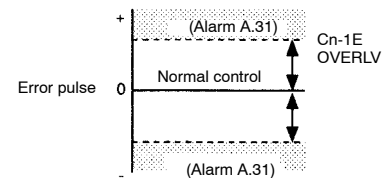

If the machine permits only a small position loop gain value to be set in Cn-1A, an overflow alarm may arise during high-speed operation. In this case, increase the value set in this parameter to suppress alarm detection.

2.6.3 Feed-forward Control



Feed-forward control shortens positioning time. To use **feed-forward control**, set the following parameter.

Cn-1D	FFGN Feed-forward Gain	Unit: %	Setting Range: 0 to 100	Factory Setting: 0	For Position Control
-------	---------------------------	------------	-------------------------------	-----------------------	----------------------

This parameter is set to apply feed-forward frequency compensation to position control inside the Servopack.

Use this parameter to shorten positioning time.

Too high a value may cause the machine to vibrate. For ordinary machines, set 80% or less in this constant.

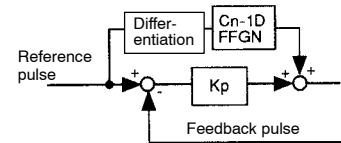

2.6.4 Proportional Control

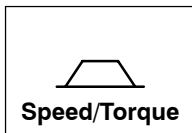

If both bits A and B of memory switch Cn-01 are set to 0 as shown below, input signal /P-CON serves as a PI/P control changeover switch.

- PI Control: Proportional/Integral control
- P Control: Proportional control

Cn-01 Bit A	Control Mode Selection	Factory Setting: 0	For Speed/Torque Control
Cn-01 Bit B	Control Mode Selection	Factory Setting: 0	For Speed/Torque Control



Feed-forward control

Control for making necessary corrections beforehand to prevent the control system from receiving the effects of disturbance.

Using feed-forward control increases effective servo gain, enhancing response performance.

Cn-01 Setting		Control Mode					
Bit B	Bit A						
0	0	<p>Speed Control This is normal speed control.</p> <ul style="list-style-type: none"> Speed reference is input from V-REF. Signal /P-CON is used to switch between P control and PI control. <table border="1"> <tr> <td>/P-CON is open (OFF)</td> <td>PI control</td> </tr> <tr> <td>/P-CON is closed (ON)</td> <td>P control</td> </tr> </table> <ul style="list-style-type: none"> Torque reference input T-REF cannot be used. 	/P-CON is open (OFF)	PI control	/P-CON is closed (ON)	P control	
/P-CON is open (OFF)	PI control						
/P-CON is closed (ON)	P control						

Using Proportional Control

Proportional control can be used in the following two ways.

- When operation is performed by sending speed references from the host controller to the Servopack, the host controller can selectively use P control mode for particular conditions only. This method can prevent the occurrence of overshoot and also shorten settling time. For particular conditions, refer to 2.6.6 Mode Switch.
- If PI control mode is used when the speed reference has a reference offset, the motor may rotate at a very slow speed and fail to stop even if 0 is specified as a speed reference. In this case, use P control mode to stop the motor.

2.6.5 Setting Speed Bias

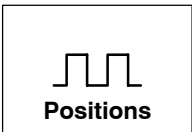

The settling time for positioning can be reduced by assigning bias to the speed reference output part in the Servopack. To assign bias, use the following constant.

Cn-1C	BIASLV Bias	Unit: min ⁻¹	Setting Range: 0 to 450	Factory Setting: 0	For Position Control

This parameter is set to assign an offset to a speed reference in the Servopack.

Use this constant to shorten settling time.

Set this parameter according to machine conditions.

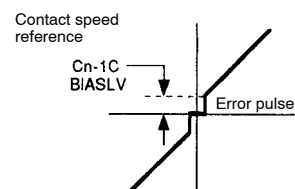

2.6.6 Mode Switch

Use the mode switch for the following purposes:

- To prevent overshoot during acceleration or deceleration (for speed control).
- To prevent undershoot during positioning in order to reduce settling time (for position control).

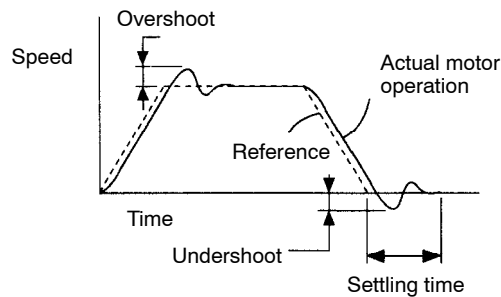

In other words, the mode switch is a function that automatically switches the speed control mode inside the Servopack **from PI control to P control** while certain conditions are being established.

- Note**
- (1) The mode switch is used to fully utilize performance of a Servo Drive to achieve very high-speed positioning. The speed response waveform must be observed to adjust the mode switch.
 - (2) For normal use, the speed loop gain and position loop gain set by autotuning provide sufficient speed/position control. Even if overshoot or undershoot occurs, they can be suppressed by setting the acceleration/deceleration time constant for the host controller, the soft start time constants (Cn-07, Cn-23), or smoothing time constant (Cn-26) for the Servopack.

Mode Switch Selection

Servopacks can use four types of mode switches (1 to 4). To select a mode switch, use the following memory switch. The mode switch setting methods for speed/torque control and position control are slightly different.



From PI control to P control

PI control means proportional/integral control and P control means proportional control. In short, switching “from PI control to P control” reduces effective servo gain, making the servo system more stable.

For Speed/Torque Control		For Position Control			Mode Switch Setting	Parameter	Unit
Memory Switch Cn-01		Memory Switch Cn-01					
Bit D	Bit C	Bit D	Bit C	Bit B			
1	1	-	-	1	Does not use mode switch.		
0	0	0	0	0	Uses torque reference as a detection point. (Standard setting)	Cn-0C	Percentage of rated torque: %
0	1	0	1	0	Uses speed reference as a detection point.	Cn-0D	Motor speed: min ⁻¹
1	0	1	0	0	Uses acceleration reference as a detection point.	Cn-0E	Acceleration reference inside the Servopack: 10 (min ⁻¹)/s
		1	1	0	Uses error pulse as a detection point.	Cn-0F	Reference unit

When Torque Reference Is Used as a Detection Point of Mode Switch (Standard Setting)

If a torque reference exceeds the torque value set in parameter Cn-0C, the speed loop switches to P control.

The Servopack is factory set to this standard mode (Cn-0C = 200).

- Example of Use:

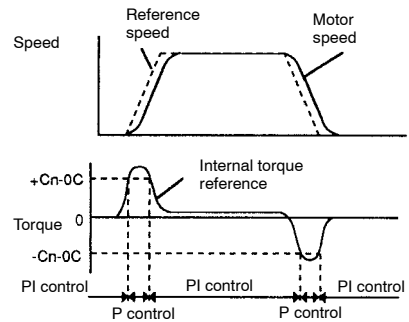

If a mode switch is not used and PI control is always performed, torque may enter a saturation state during acceleration or deceleration, causing the motor speed to have overshoot or undershoot.

Using the mode switch suppresses torque saturation and prevents the motor speed from having overshoot and undershoot.

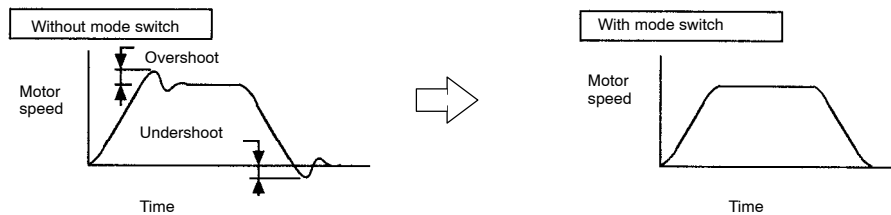

Using Speed Reference as a Detection Point of Mode Switch

If a speed reference exceeds the value set in parameter Cn-0D, the speed loop switches to P control.

- Example of Use:

The mode switch is used to reduce settling time.

Generally, speed loop gain must be increased to reduce settling time. Using the mode switch suppresses the occurrence of overshoot and undershoot when speed loop gain is increased.

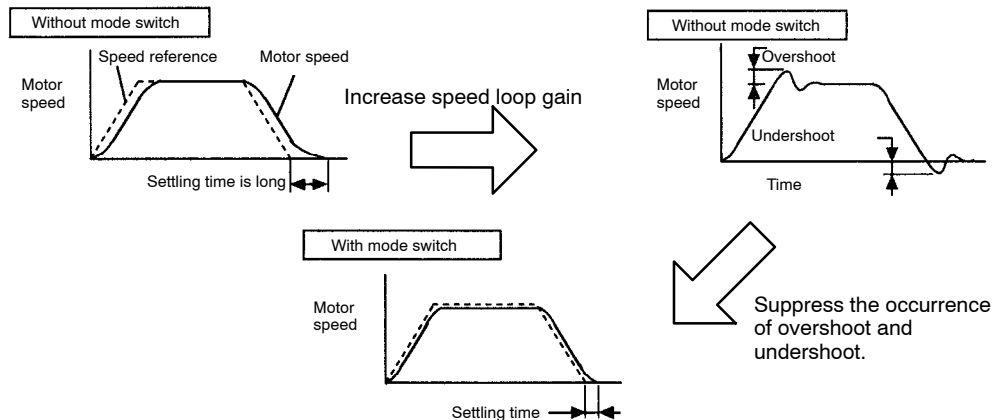
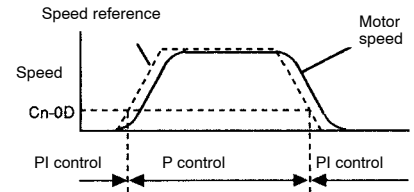

Using Acceleration as a Detection Point of Mode Switch (Standard Setting)

If motor acceleration exceeds the value set in parameter Cn-0E, the speed loop switches to P control.

- Example of Use:

If a mode switch is not used and PI control is always performed, torque may enter a saturation state during acceleration or deceleration, causing the motor speed to have overshoot or undershoot.

Using the mode switch suppresses torque saturation and prevents the motor speed from having overshoot and undershoot.

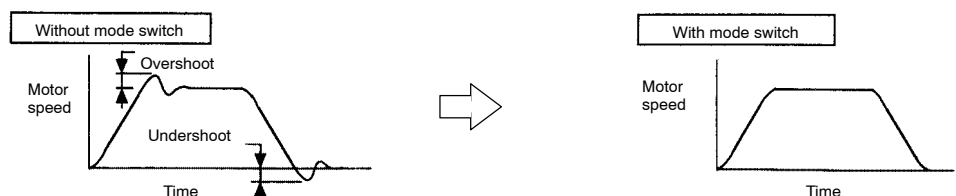
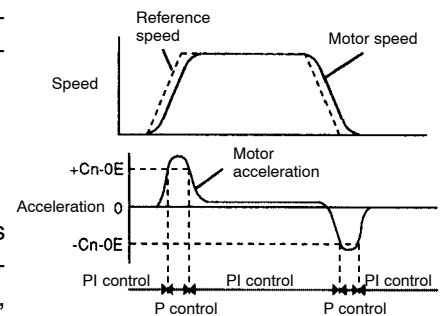

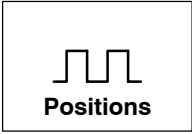

Using Error Pulse as a Detection Point of Mode Switch

Error pulse can be used for position control only.

If an error pulse exceeds the value set in parameter Cn-0F, the speed loop switches to P control.

- Example of Use:

The mode switch is used to reduce settling time.

Generally, speed loop gain must be increased to reduce settling time. Using the mode switch suppresses the occurrence of overshoot and undershoot when speed loop gain is increased.

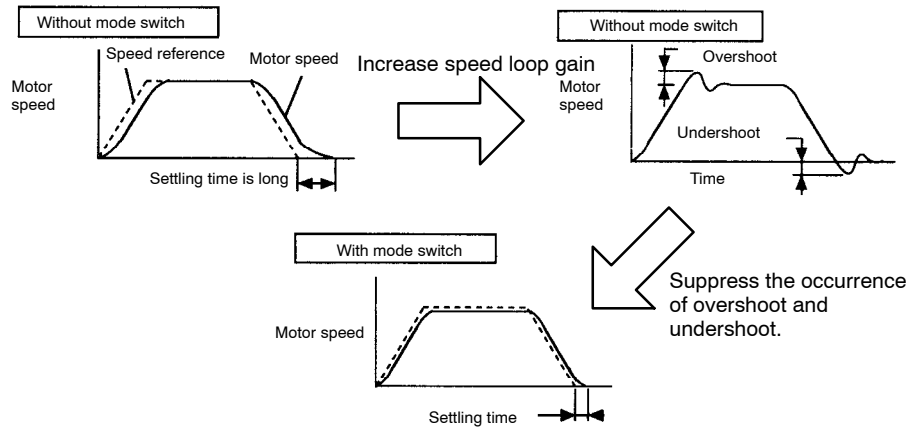
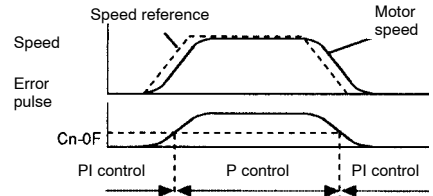

Parameters

The parameters required to set each mode switch are summarized as follows.

Cn-01 Bit B	Mode Switch ON/OFF	Factory Setting: 0	For Position Control
--------------------	--------------------	--------------------	----------------------



This parameter is used to enable or disable the mode switch function.

Setting	Meaning
0	Uses the mode switch function
1	Does not use the mode switch function

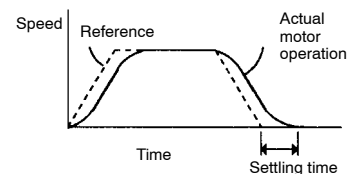

Mode switch is used to reduce settling time and suppress undershoot when the motor stops. It switches PI control to P control when certain conditions are met.

The Servopack allows use of four different types of mode switch. To select a mode switch, set bits C and D of memory switch Cn-01.

Cn-01 Bit C	Mode Switch Selection	Factory Setting: 0	For Speed/Torque Control and Position Control
Cn-01 Bit D	Mode Switch Selection	Factory Setting: 0	For Speed/Torque Control and Position Control

2

Use the following parameters to set the mode switch to be used.

Memory Switch Cn-01		Mode Switch Type		Parameter for Setting Detection Point
Bit D	Bit C			
0	0	Uses torque reference as a detection point.		Cn-0C
0	1	Uses speed reference as a detection point.		Cn-0D
1	0	Uses acceleration reference as a detection point.		Cn-0E
1	1	For speed/ torque control	Does not use mode switch.	/
		For position control	Uses error pulse as a detection point.	

The mode switch is used to reduce settling time and suppress undershoot when the motor stops. It switches PI control to P control when certain conditions are met.

Parameter	Mode Switch	Mode Switch (Reference)	Unit	Setting Range	Factory Setting	Control Mode
Cn-0C	TRQMSW	Mode Switch (Torque Reference)	Unit: %	Setting Range: 0 to Maximum Torque	Factory Setting: 200	For Speed/Torque Control and Position Control
Cn-0D	REFMSW	Mode Switch (Speed Reference)	Unit: min^{-1}	Setting Range: 0 to Maximum Speed	Factory Setting: 0	For Speed/Torque Control and Position Control
Cn-0E	ACCMSW	Mode Switch (Acceleration Reference)	Unit: $10 (\text{min}^{-1})/\text{s}$	Setting Range: 0 to 3000	Factory Setting: 0	For Speed/Torque Control and Position Control
Cn-0F	ERPMSW	Mode Switch (Error Pulse)	Unit: Reference Unit	Setting Range: 0 to 10000	Factory Setting: 10000	For Position Control

The mode switch is used to reduce settling time and suppress undershoot when the motor stops. It switches PI control to P control when certain conditions are met.

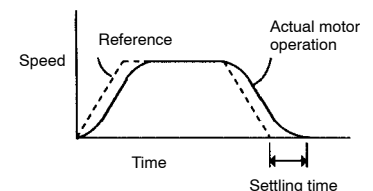

The Servopack allows use of four different types of mode switch. To select a mode switch, set bits B, C and D of memory switch Cn-01.

2

Memory Switch Cn-01			Mode Switch Setting	Parameter	Unit
Bit D	Bit C	Bit B			
-	-	1	Does not use mode switch.		
0	0	0	Uses torque reference as a detection point.	Cn-0C	Percentage of rated torque: %
0	1	0	Uses speed reference as a detection point.	Cn-0D	Motor speed: min ⁻¹
1	0	0	Uses acceleration reference as a detection point.	Cn-0E	Acceleration reference inside the Servopack: 10 (min ⁻¹)/s
1	1	0	Uses error pulse as a detection point.	Cn-0F	Reference unit

Parameter Cn-0F is for position control only.

2.6.7 Speed Loop Compensation

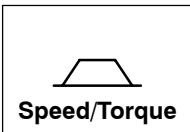

- 1) This function compensates for the phase-delay generated by the digital control speed detection. For this function, use the following constant.

Cn-28	NDBCC Speed Loop Compensation Constant	Unit: —	Setting Range: 0 to 100	Factory Setting: 0	For Speed/Torque Control
--------------	--	---------	-------------------------	--------------------	--------------------------

First, adjust the servo (position/speed loop gain, speed loop, integration time constant, torque reference filter) appropriately in the “Cn-28 = 0” status.

Next, gradually increase the set value of Cn-28 from 0, find the proper value at which noise and oscillation are minimal.

Note Use the speed loop compensation function (set value of Cn-28 is other than 0) under the following conditions:

- No servo system oscillation
- No abnormal noise from the machine

Even if the speed loop compensation function is used, it may bring little effect or even increase the oscillation. In these cases, stop using the speed loop compensation function. (Set the value of Cn-28 to 0, again.)

2) Speed loop compensation function is illustrated in the following block diagram:

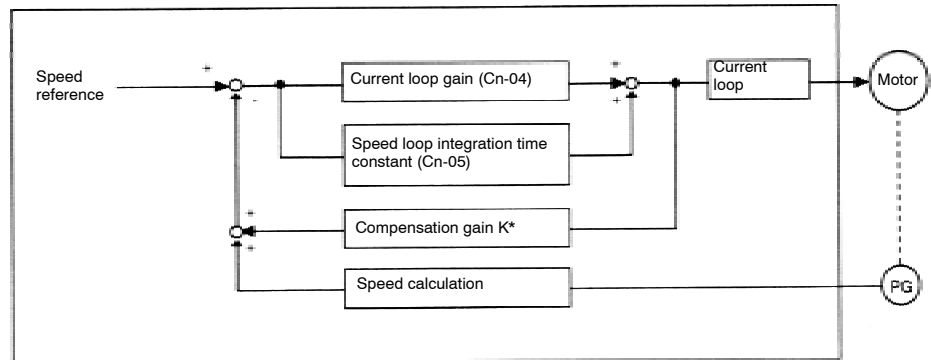

* Compensation gain (K) is in proportion to the compensation constant (parameter Cn-28). Cn-28 = 0 shows no compensation status.

2.7 Designing a Protective Sequence

This section describes how to use I/O signals from the Servopack to form a protective sequence for safety purposes.

2.7.1 Servo Alarm Output

The following diagram shows the basic wiring for alarm output signals.

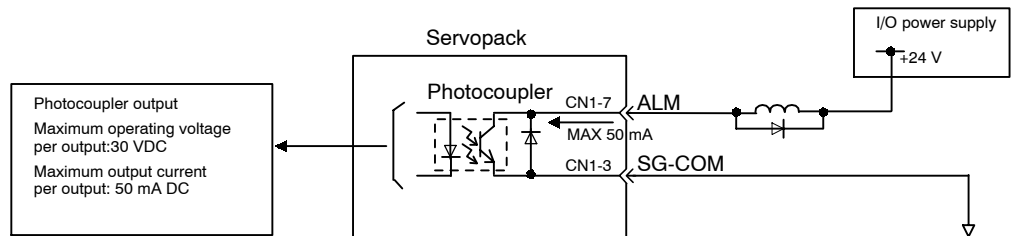

Provide an external I/O power supply separately. There are no DC power available from Servopack for output signals.

Contact Output Signal ALM

Output → ALM CN1-7	Servo Alarm Output	For Speed Torque and Position Control
Output → SG-COM CN1-3	Signal Ground for Servo Alarm Output	For Speed Torque and Position Control

Signal ALM is output when the Servopack detects an alarm.

Form an external circuit so that the alarm output (ALM) turns OFF the Servopack.

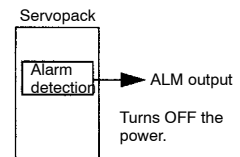

ON status:	Circuit between CN1-7 and CN1-35 is closed. CN1-7 is at low level.	Normal state
OFF status:	Circuit between CN1-7 and CN1-35 is open. CN1-7 is at high level.	Alarm state

The following table provides details of the alarm displays.

Alarm Display and Alarm Code Output

Alarm Display	Servo Alarm (ALM) Output	Alarm Type	Alarm Description
R00*	OFF	Parameter error	An absolute encoder error occurred or parameter is faulty.
R10	OFF	Overcurrent	Overcurrent flowed through the main circuit. Servopack overheated.
R31	OFF	Position error pulse overflow	The number of pulses in error counter has exceeded the preset value.
R51	OFF	Overspeed	Motor speed has exceeded the maximum allowable speed.
R70	OFF	Overload	Motor and Servopack are overloaded.
R80	OFF	Encoder error	An error occurred in the number of feedback pulses from the Encoder.
AL0*	OFF	Overrun Disconnection of encoder signal line	Overrun occurred due to motor or encoder signal wiring faults. Encoder signal line is disconnected.
CPFD0	Undefined	Digital Operator transmission error	Communication error occurred between Digital Operator and Servopack.
CPFD1			
R99	ON	No error	---

ON: Output transistor is ON

OFF: Output transistor is OFF

* : Displays an alarm category number.

For details, refer to *Appendix D List of Alarm Displays*.

When the servo alarm (ALM) is output, eliminate the cause of the alarm and set the following /ALMRST input signal at high level (+24 V) to reset the alarm state.

→ Input /ALMRST CN1-*1	Alarm Reset	For Speed/Torque Control and Position Control
-------------------------------	-------------	---

This signal is used to reset the servo alarm state.

Normally, this signal terminal need not be wired. This is because an external circuit is normally formed so that servo power is turned OFF when servo alarm is output. Alarm state is automatically reset when servo power is turned ON next time.

Alarm state can be reset using the Digital Operator.

When an alarm occurs, always eliminate the cause before resetting the alarm state. Refer to 5.2.1 *Troubleshooting Problems with Alarm Display* for details on how to troubleshoot the system when an alarm arises.

2

2.7.2 Servo ON Input Signal

This section describes how to wire and use contact input signal “servo ON (/S-ON).” Use this signal to forcibly turn OFF the Servomotor from the host controller.

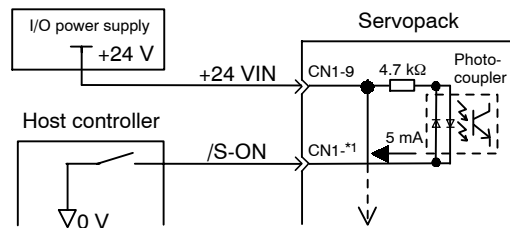

→ Input /S-ON CN1-*1	Servo ON	For Speed/Torque Control and Position Control
----------------------	----------	---

This signal is used to turn the motor ON or OFF.

ON: CN1-*1 is at low level	Turns ON the motor. This is normal operation state (called “servo ON state”).
OFF: CN1-*1 is at high level	Turns OFF the motor. This is inoperable state (called “servo OFF state”). If the servo is turned OFF during motor operation, the motor is decelerated to a stop by applying dynamic brake.

Servo ON

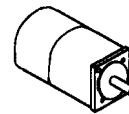

Motor is ON
Motor is operated according to input signals.

Servo OFF

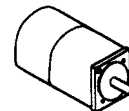

Motor is OFF
Motor cannot run.

Note Do not use the /S-ON signal to start or stop the motor. Always use an input reference to start and stop the motor.

If the /S-ON signal is not to be used, set the following memory switch to 1.

Cn-01 Bit 0	Use of Servo ON Input Signal	Factory Setting: 0	For Speed/Torque Control and Position Control
--------------------	------------------------------	--------------------	---

This memory switch is used to enable or disable the servo ON input signal /S-ON.

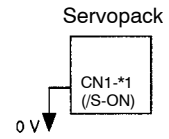

When external short-circuit wiring is omitted, set the memory switch to "1."

When /S-ON is not used, this short-circuit wiring can be omitted.

Setting	Meaning
0	Uses servo ON signal /S-ON
1	Does not use Servo ON signal /S-ON. (Servo is always ON.)

2.7.3 Positioning Complete Output



This section describes how to wire and use contact output-signal "positioning complete output (/COIN)." This signal is output to indicate that Servomotor operation is complete.

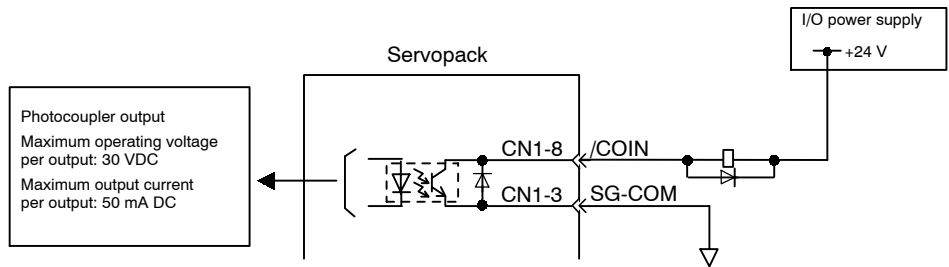

Output → /COIN CN1-8	Positioning Complete Output	For Position Control
-----------------------------	-----------------------------	----------------------

This output signal indicates that motor operation is complete during position control. The host controller uses this signal as an interlock to confirm that positioning is complete.

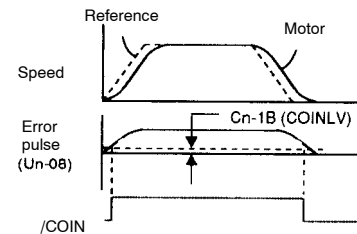

ON status:	Circuit between CN1-8 and CN1-3 is closed. CN1-8 is at low level.	Positioning is complete (position error is below the preset value).
OFF status:	Circuit between CN1-8 and CN1-3 is open. CN1-8 is at high level.	Positioning is not complete (position error is over the preset value).

Preset Value: Cn-1B (positioning complete range)

Set the number of error pulses in the following parameter to adjust output timing of /COIN (positioning complete output).

Cn-1B	COINLV	Positioning Complete Range	Unit: Reference Unit	Setting Range: 0 to 250	Factory Setting: 1	For Position Control
--------------	--------	----------------------------	----------------------	-------------------------	--------------------	----------------------

This parameter is used to set output timing of positioning complete signal (/COIN) to be output when motor operation is complete after a position reference pulse has been input.

Set the number of error pulses in terms of reference unit (the number of input pulses that is defined using the electronic gear function).

If too large a value is set in this parameter, error may become too small when the motor runs at a low speed, causing /COIN to be output continuously.

COINLV does not affect the final positioning accuracy.

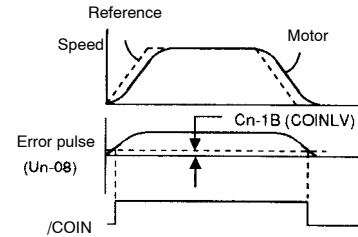

2.7.4 Speed Coincidence Output

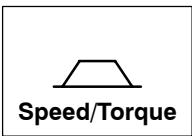

This section describes how to wire and use contact output signal “speed coincidence output (/V-CMP).” This signal is output to indicate that actual motor speed matches a reference speed. The host controller uses this signal as an interlock.

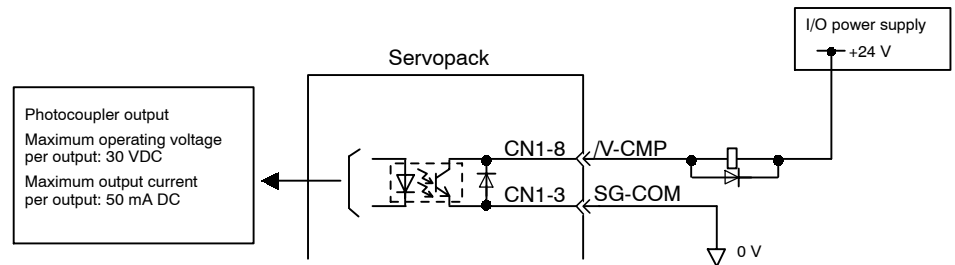

Output → /V-CMP CN1-8	Speed Coincidence Output	For Speed/Torque Control
------------------------------	--------------------------	--------------------------

This output signal indicates that actual motor speed matches the input speed reference during speed control.

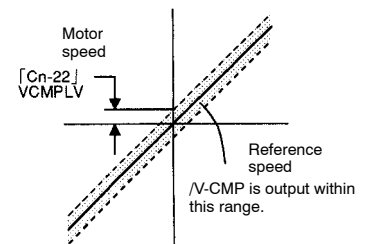

ON status:	Circuit between CN1-8 and CN1-3 is closed. CN1-8 is at low level.	Actual motor speed matches the speed reference (speed difference is below the preset value).
OFF status:	Circuit between CN1-8 and CN1-3 is open. CN1-8 is at high level.	Actual motor speed does not match the speed reference (speed difference is greater than the preset value).

2

Preset value: Cn-22 (speed coincidence signal output width)

Set the following parameter to specify the output conditions for speed coincidence signal output.

Cn-22	VCMPPLV	Speed Coincidence Signal Output Width	Unit: min ⁻¹	Setting Range: 0 to 100	Factory Setting: 10	For Speed/Torque Control
--------------	---------	---------------------------------------	-------------------------	-------------------------	---------------------	--------------------------

Set the output conditions for speed coincidence signal /V-CMP.

The /V-CMP signal is output when the difference between the reference speed and actual motor speed is not greater than the preset value.

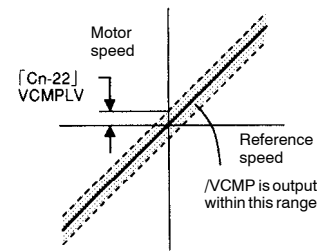

Example: When preset value is 100 and reference speed is 2000 min⁻¹.

/V-CMP is ON (circuit between CN1-8 and CN1-3 is closed) when the speed is between 1900 and 2100 min⁻¹.

2.7.5 Running Output Signal

This section describes how to wire and use contact output signal /TGON as a running output signal. This signal indicates that a Servomotor is currently running.

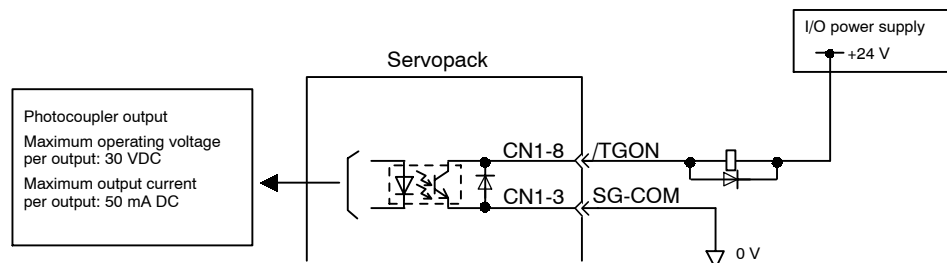

Output → /TGON CN1-8	Running Output (Torque Limit Output)	For Speed/Torque Control and Position Control
-----------------------------	--------------------------------------	---

This output signal indicates that the motor is currently running.

It is used as an external interlock.

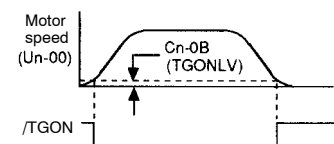

ON status:	Circuit between CN1-8 and CN1-3 is closed. CN1-8 is at low level.	Motor is running. (Motor speed is greater than the preset value.)
OFF status:	Circuit between CN1-8 and CN1-3 is open. CN1-8 is at high level.	Motor is stopped. (Motor speed is below the preset value.)

Preset value: Cn-0B (zero-speed level)

Use the following parameter to specify the output conditions for running output signal /TGON.

Cn-0B	TGONLV	Zero-speed Level	Unit: min ⁻¹	Setting Range: 1 to Maximum Speed	Factory Setting: 20	For Speed/Torque Control and Position Control
--------------	--------	------------------	-------------------------	-----------------------------------	---------------------	---

This parameter is used to set the speed level at which the Servopack determines that the motor is running and then outputs a signal.

The following signals are output when motor speed exceeds the preset value.

<ul style="list-style-type: none"> ● /TGON ● Status indication mode bit data ● Monitor mode Un-05 bit 4
Parameter Setting: Cn-2C = 1

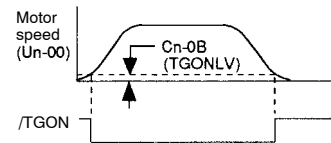

Note Precautions for Setting Clear Servo Alarm:

To change a parameter that is made valid by turning the Servopack OFF and then ON, always wait for at least the “power holding time” after the Servopack is turned OFF, then turn ON the Servopack. Follow the procedure below and then turn ON the power again.

- a) Make sure that all indicators (LEDs) on the Digital Operator are not lit.
- b) Make sure that the power and alarm indicators (LEDs) on the front panel of the Servopack are not lit.

Reason

When the servo alarm contents is cleared, the Servopack will operate normally even if it is turned ON without waiting for the “power holding time” to lapse after being turned OFF. The inside of the Servopack, however, will not yet have been reset (power ON reset). Therefore, parameters that have been modified do not become valid if these constants are made valid by turning the power OFF and then ON. Although the modified (new) settings appear on the display, the old settings are still valid inside the Servopack.

2.8 Special Wiring

This section describes special wiring methods including the one for noise control. Always refer to *2.8.1 Wiring Precautions* and *2.8.2 Noise Control*, and refer to other sections as necessary.

2.8.1 Wiring Precautions

To ensure safe and stable operation, always refer to the following wiring precautions.

- 1) Use the following cables for reference input and encoder wiring.

Purpose	Cable Type	Yaskawa Drawing No.	Maximum Allowable Length
For reference input	Twisted-pair cable	DE9404859	3 m (9.8 ft.)
For encoder	Multiconductor shielded twisted-pair cable	JZSP-CFP09 (for incremental encoder)	5 m (16.40 ft.)

- Trim off the excess portion of the cable to minimize the cable length.

- 2) For the ground wire, use as thick a cable as possible.

- Ground resistance of 100 Ω or less is recommended.
- Always use one-line ground.
- If the motor is insulated from the machine, ground the motor directly.

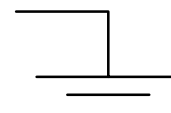

- 3) Do not bend or apply tension to cables.

- Since the conductor of a signal cable is very thin (0.2 to 0.3 mm), handle it with adequate care.

- 4) Use a noise filter to prevent radio interference.
(For details, refer to *2.8.2 Wiring for Noise Control*.)

- If the servo is to be used near private houses or may receive radio interference, install a noise filter on the input side of the power supply line. Since this Servopack is designed as an industrial device, it provides no mechanism to prevent radio interference.

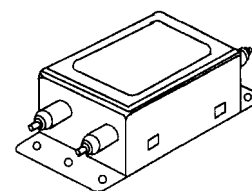

- 5) Observe the following precautions to prevent malfunctions due to noise interference.
- Position the input reference device and noise filter as close to the Servopack as possible.
 - Always install a surge absorber circuit in the relay, solenoid and magnetic contactor coils.
 - The distance between a power line (such as a power supply line or motor cable) and a signal line must be at least 30 cm (12 in). Do not put the power and signal lines in the same duct or bundle them together.
 - Do not share the power supply with an electric welder or electrical discharge machine. When the Servopack is placed near a high-frequency oscillator, install a noise filter on the input side of the power supply line.

Note a) Since Servopack uses high-speed switching elements, signal lines may receive noise. To prevent this, always take the above actions.
 b) For details of grounding and noise filters, refer to 2.8.2 Wiring for Noise Control.

- 6) Use a molded-case circuit breaker (MCCB) or fuse to protect the power supply line from high voltage.

- The Servopack is directly connected to commercial power supply without a transformer. Always use an MCCB or fuse to protect the servo system from accidental high voltage.
- Select an appropriate MCCB or fuse according to the Servopack capacity and the number of Servopacks to be used as shown in the following table.

Molded-case Circuit Breaker (MCCB) for Wiring

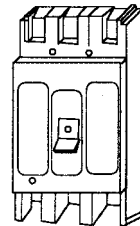

MCCB or Fuse for Each Power Capacity

Servopack Type	Power Capacity Per Servopack (W) (see note 1)	Power Capacity Per MCCB or Fuse (A) (see note 2)
SGDF-A1C	28	5
SGDF-A2C	42	5
SGDF-A3C	60	5
SGDF-B3C	22	5
SGDF-B5C	24	5
SGDF-B9C	30	5

- Note**
- 1) Power capacity at rated load.
 - 2) Operating characteristics (25°C): 2 seconds or more for 200%, 0.01 second or more for 700%.
 - 3) A fast-operating fuse cannot be used because the Servopack power supply is a capacitor input type. A fast-operating fuse may blow out when the power is turned ON.

2.8.2 Wiring for Noise Control

Example of Wiring for Noise Control

This Servopack uses high-speed switching elements in the main circuit. It may receive “switching noise” from these high-speed switching elements if wiring or grounding around the Servopack is not appropriate. To prevent this, always wire and ground the Servopack correctly.

This Servopack has a built-in microprocessor (CPU). To protect the microprocessor from external noise, install a noise filter in place.

The following is an example of wiring for noise control.

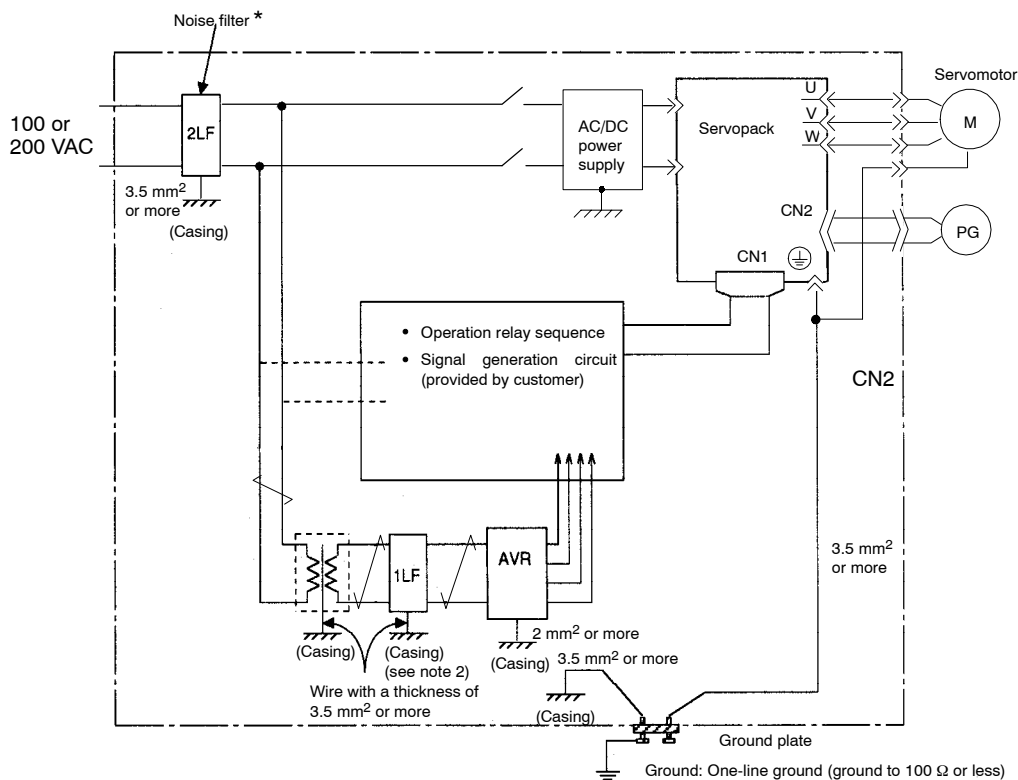

* When using a noise filter, always observe the following wiring instructions:

- Note**
- 1) For a ground wire to be connected to the casing, use a thick wire with a thickness of at least 3.5 mm^2 (preferably, plain stitch copper wire).
 - 2) For wiring indicated by \sphericalangle , use twisted-pair cable whenever possible.

Correct Grounding

- Always ground the motor frame.

Always connect the Servomotor frame terminal to the Servopack ground terminal. Be sure to ground the ground terminal.

- If the Servomotor is grounded via the machine, a switching noise current will flow from the Servopack power unit through motor stray capacitance. The above grounding is required to prevent the adverse effects of switching noise.
- Ground the 0 V line (such as SG) of the reference input line. If the main circuit wiring for the motor is accommodated in a metal conduit, ground the conduit and its junction box. For all grounding, always use one-line ground.

Noise Filter Installation

Use an inhibit type noise filter to prevent noise from the power supply line.

Install a noise filter on the power supply line for peripheral equipment as necessary.

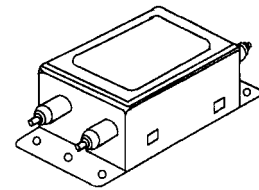

The following table lists recommended noise filters for each Servopack type.

Table 2.1 Noise Filters

Servopack Type		Noise Filter Connection	Recommended Noise Filter (See Note.)	
			Type	Specifications
10 W	SGDF-A1C□	(Correct) 	LF-205A	Single-phase 200 VAC, 5 A
20 W	SGDF-A2C□			
30 W	SGDF-A3C□			
3 W	SGDF-B3C□	(Incorrect) 	LF-205A	Single-phase 200 VAC, 5 A
5 W	SGDF-B5C□			
10 W	SGDF-B9C□			

Note These noise filters are manufactured by Tokin Corp. and are available from Yaskawa. For noise filters, contact your nearest Yaskawa sales representatives.

Always observe the following installation and wiring precautions. Incorrect use of a noise filter significantly diminishes its benefits.

- Separate input lines from output lines.

Do not put the input and output lines in the same duct or bundle them together.

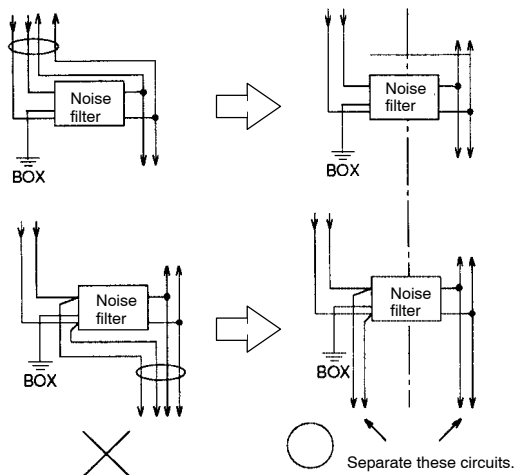
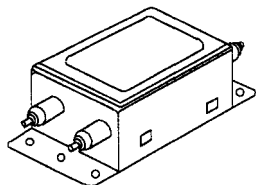

- Separate the noise filter ground wire from the output lines.

Do not accommodate the noise filter ground wire, output lines and other signal lines in the same duct or bundle them together.

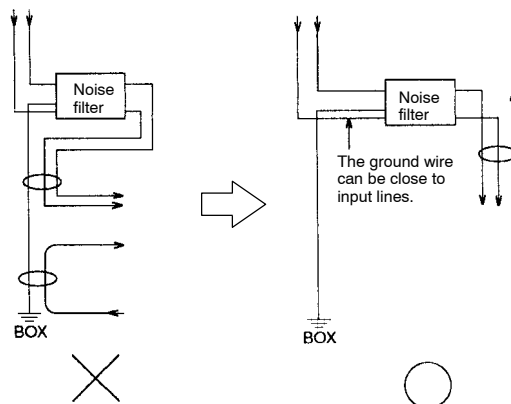

- Connect the noise filter ground wire directly to the ground plate.

Do not connect the noise filter ground wire to other ground wires.

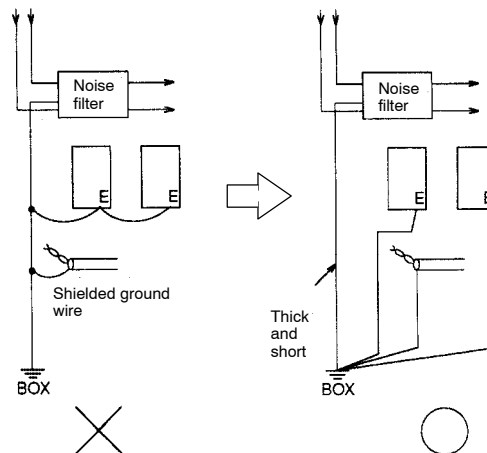

APPLICATIONS

2.8.2 Wiring for Noise Control cont.

- Ground a noise filter that is inside the Unit as follows:

If a noise filter is located inside a Unit, connect the noise filter ground wire and the ground wires from other devices inside the Unit to the ground plate for the Unit first, then ground these wires.

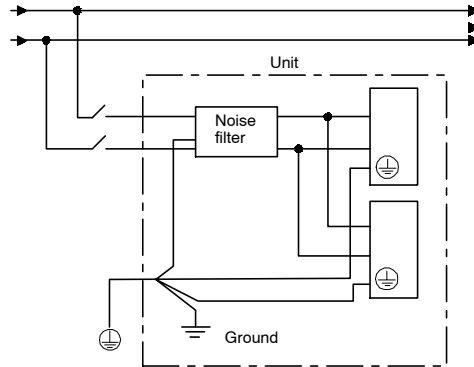

2.8.3 Using More Than One Servo Drive

The following diagram shows an example of wiring more than one Servo Drive.

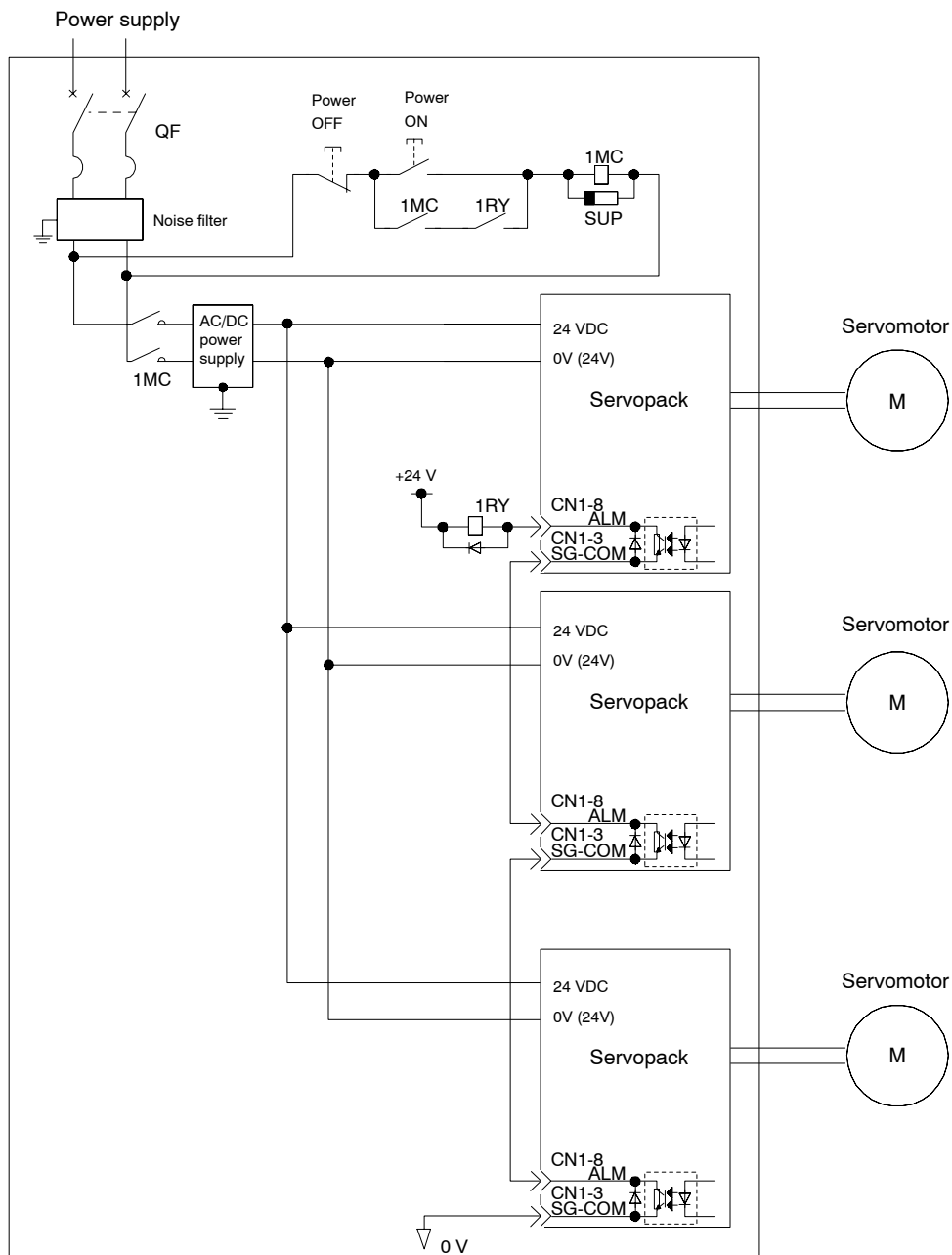

Connect the alarm output (ALM) terminals for the three Servopacks in series to enable alarm detection relay 1RY to operate. This is because ALM is a logical complement output signal, so the output transistor is turned OFF when the system enters an alarm state.

Multiple servos can share a single MCCB or noise filter. Always select an MCCB or noise filter that has enough capacity for the total power capacity (load conditions) of those servos. For details, refer to page 2-68.

MCCB

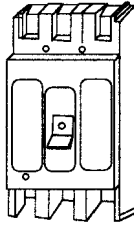

Noise filter

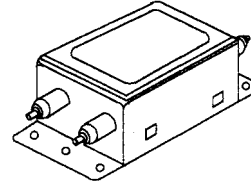

2.8.4 Connector Terminal Layouts

This section describes connector terminal layouts for Servopacks, Servomotors and Digital Operators.

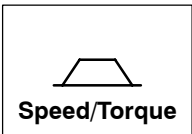

Servopack Connectors for Speed/Torque Control

CN1 Terminal Layout

2	IN2	Contact input signal 2	1	IN1	Contact input signal 1	12	V-REF, T-REF	Reference input	11	---	---
4	---	---	3	SG-COM	Output signal 0 V	14	PAO	PG output phase A	13	SG	0 V
6	---	---	5	---		16	PBO	PG output phase B	15	/PAO	PG output phase A
8	OUT2	Output signal 2	7	ALM	Alarm output	18	PCO	PG output phase C	17	/PBO	PG output phase B
10	---	---	9	+24 VIN	External input power supply	20	FG	Frame ground	19	/PCO	PG output phase C

CN2 Terminal Layout

2	PG0 V	PG power supply, 0 V	1	PG0V	PG power supply, 0 V	12	---	---	11	---	---
4	PG5 V	PG power supply, 5 V	3	PG0V	PG power supply, 5 V	14	PC	PG output phase C	13	---	---
6	PG5V		5	PG5V		16	PA	PG output phase A	15	/PC	PG output phase C
8	---	---	7	---	---	18	PB	PG output phase B	17	/PA	PG output phase A
10	---	---	9	---	---	20	FG	Frame ground	19	/PB	PG output phase B

• Servopack End: Connector model: 52822-4011 (manufactured by Molex Japan)

- **Cable End:** Connector model (including case): 54331-0201 (manufactured by Molex Japan)



Servopack Connectors for Position Control

CN1 Terminal Layout

2	IN2	Contact input signal 2	1	IN1	Contact input signal 1	11	PAO	PG output phase A
4	---	---	3	SG-COM	Output signal 0 V	12	PBO	PG output phase B
6	---	---	5	---	---	13	SG	0 V
8	OUT2	Output signal 2	7	ALM	Alarm output	14	PULS	Reference pulse input
10	PCO	PG output phase C	9	+24 VIN	External input power supply	15	/PULS	Reference pulse input
						16	SIGN	Reference sign input
						17	/SIGN	Reference sign input
						18	CLR	Clear error counter input
						19	/CLR	Clear error counter input
						20	FG	Frame ground

CN2 Terminal Layout

2	PG0 V	PG power supply 0 V	1	PG0V	PG power supply 0 V	11	---	---
4	PG5 V	PG power supply 5 V	3	PG0V	PG power supply 0 V	12	---	---
6	PG5V		5	PG5V		PG power supply 5 V	13	---
8	---	---	7	---	---	14	PC	PG output phase C
10	---	---	9	---	---	15	/PC	PG output phase C
						16	PA	PG output phase A
						17	/PA	PG output phase A
						18	PB	PG output phase B
						19	/PB	PG output phase B
						20	FG	Frame ground

- **Servopack End:** Connector model: 52822-4011 (manufactured by Molex Japan)
- **Cable End:** Connector model (including case): 54331-0201 (manufactured by Molex Japan)

Connectors for Encoder

- For SGMM-A□C

1	Channel A output	Blue
2	Channel /A output	Blue/Black
3	Channel B output	Yellow
4	Channel /B output	Yellow/Black
5	Channel C output	Green
6	Channel /C output	Green/Black
7	0 V (power supply)	Gray
8	+5 V (power supply)	Red
9	Frame ground (FG)	Orange

Items to be Prepared by Customer
 Cap: 51112-0910
 Socket: 50398-8000 (chain type) or
 50398-8100 (loose type)
 (Manufactured by Molex Japan)

Items to be Prepared by Customer
 Case and Connector:
 54331-0201
 (Manufactured by Molex Japan)

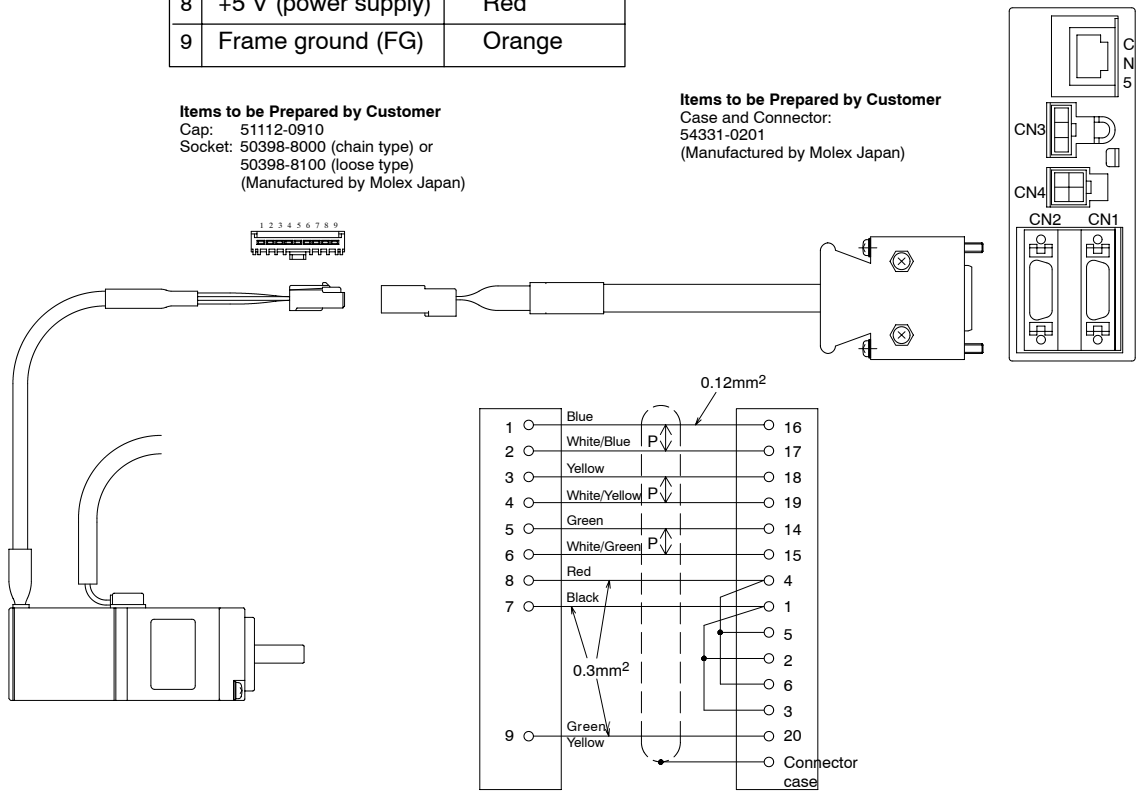

2

- For SGMM-B□C

1	Channel A output	Blue
2	Channel B output	Yellow
3	Channel C output	Green
4	0 V (power supply)	Gray
5	Frame ground (FG)	Orange
6	Channel /A output	Blue/Black
7	Channel /B output	Yellow/Black
8	Channel /C output	Green/Black
9	+5 V (power supply)	Red

Items to be Prepared by Customer
 Cap: 43020-1001
 Socket: 43031-0004
 (Manufactured by Molex Japan)

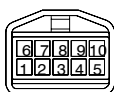

Items to be Prepared by Customer
 Case and Connector:
 54331-0201
 (Manufactured by Molex Japan)

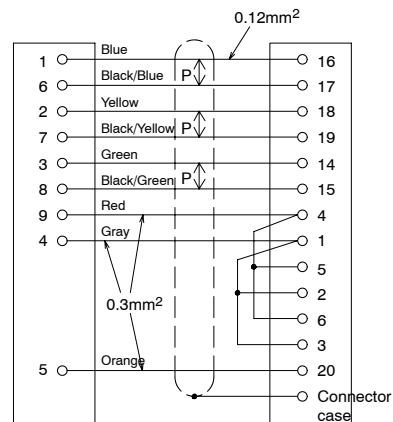
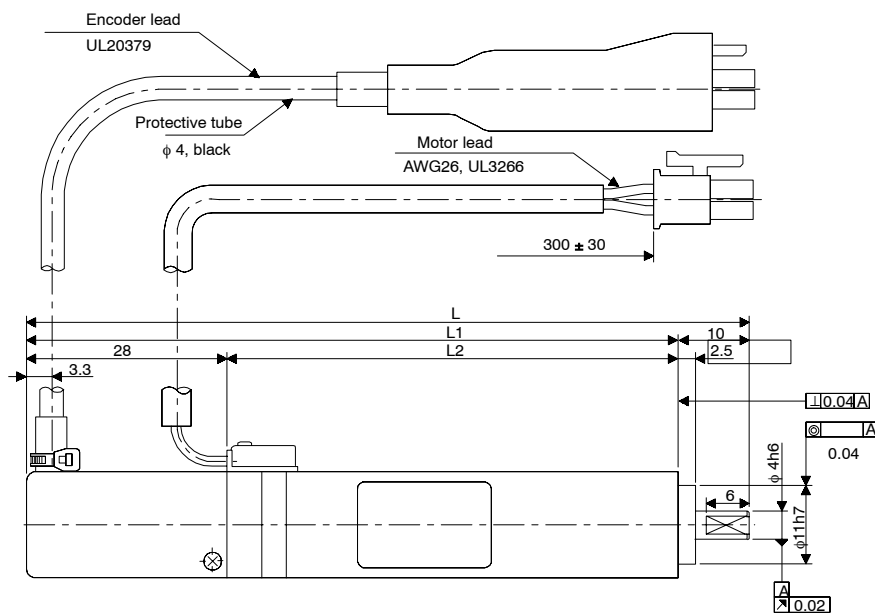
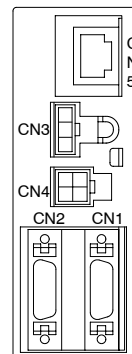

Connectors and Terminals for Standard Motor

- For SGMM-A□C

- Without Brake

1	Phase U	Red
2	Phase V	White
3	Phase W	Blue
4	Frame ground (FG)	Green

Cap: 5559-04P-210
 Socket: 5558T (chain type) or 5558TL (loose type)
 (Manufactured by Molex Japan)

Items to be Prepared by Customer

Receptacle: 5557-D4R-210
 Socket: 5556T (chain type) or 5556TL (loose type)
 (Manufactured by Molex Japan)

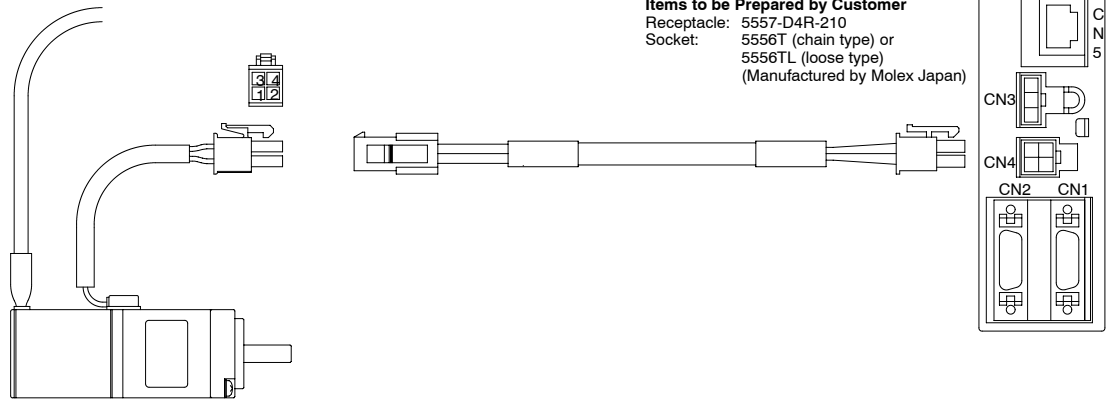

- With Brake

1	Phase U	Red
2	Phase V	White
3	Phase W	Blue
4	Frame ground (FG)	Green
5	Brake	Black
6	Brake	Black

Cap: 5559-06P-210
 Socket: 5558T (chain type) or 5558TL (loose type)
 (Manufactured by Molex Japan)

Items to be Prepared by Customer

Receptacle: 5557-04R-210
 Socket: 5556T (chain type) or 5556TL (loose type)
 (Manufactured by Molex Japan)

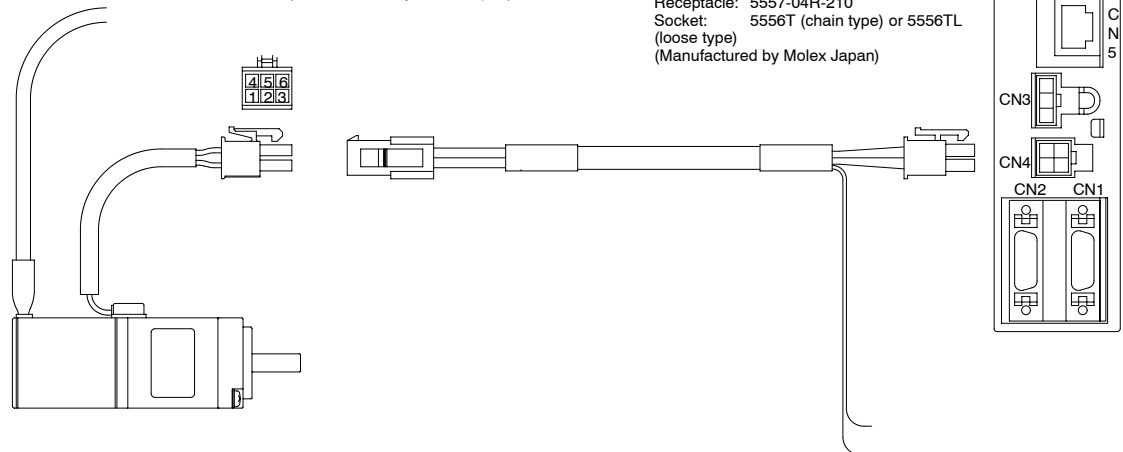

- For SGMM-B□C

1	Phase U	Red
2	Phase V	White
3	Phase W	Blue
4	Frame ground (FG)	Green

Items to be Prepared by Customer
 Cap: 43020-0401
 Socket: 43031-0004
 (Manufactured by Molex Japan)

Items to be Prepared by Customer
 Receptacle: 5557-04R-210
 Socket: 5556T (chain type) or
 5556TL (loose type)
 (Manufactured by Molex Japan)

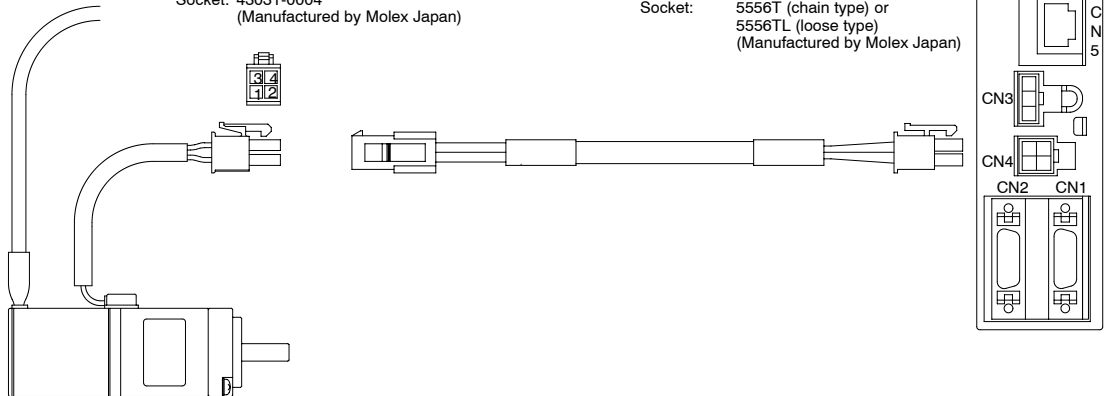

2

Connectors for Digital Operator

- JUSP-OP02A-3 (Hand-held Type)

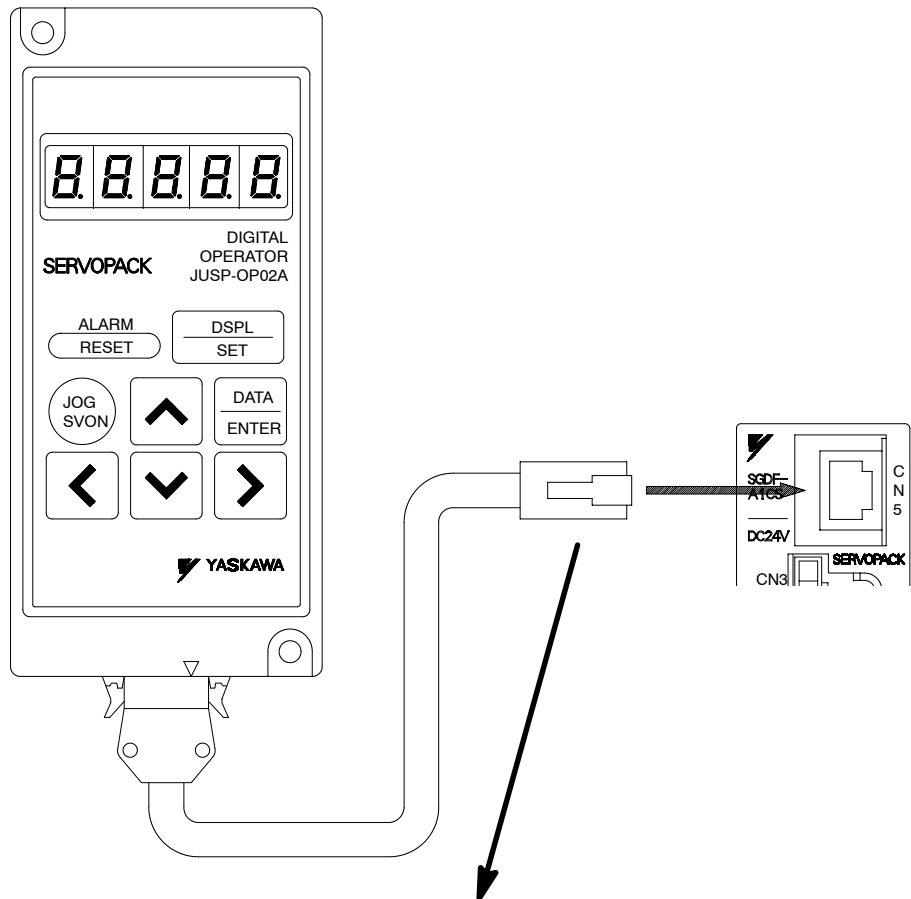

Pin No.	Signal Name	Signal Circuit Name	Signal Direction
1	TXD	Transmit data (non-inversion side)	P←S
2	/TXD	Transmit data (inversion side)	P←S
3	RXD	Receive data (non-inversion side)	P→S
4	/RXD	Receive data (inversion side)	P→S
5	OPH		#
6	—	—	—
7	5VPP		#
8	GND	Signal ground 0 V	

2

USING THE DIGITAL OPERATOR

3

This chapter describes the basic operations of the Digital Operator and the convenient features it offers. The Digital Operator can be used to set parameters and perform various motor operations. Operate the Digital Operator as you read through this chapter.

3

3.1 Basic Operations	3-2
3.1.1 Connecting the Digital Operator	3-2
3.1.2 Resetting Servo Alarms	3-3
3.1.3 Basic Functions and Mode Selection	3-4
3.1.4 Operation in Status Display Mode	3-5
3.1.5 Operation in Parameter Setting Mode	3-7
3.1.6 Operation in Monitor Mode	3-9
3.2 Applications	3-13
3.2.1 Operation in Alarm Traceback Mode	3-13
3.2.2 Operation Using the Digital Operator	3-15
3.2.3 Autotuning	3-16
3.2.4 Reference Offset Automatic Adjustment	3-21
3.2.5 Reference Offset Manual Adjustment	3-22
3.2.6 Clearing Alarm Traceback Data	3-25
3.2.7 Checking Motor Type	3-26
3.2.8 Checking Software Version	3-26

3.1 Basic Operations

■ This section describes basic operations using the Digital Operator.

3.1.1 Connecting the Digital Operator

The Servopack can be used with the JUSP-OP02A-3 Digital Operator (Hand-held type). The Digital Operator is connected to the Servopack as shown below. The Digital Operator connector can be connected or disconnected while the Servopack power is ON.

3

JUSP-OP02A-3 (Hand-held Type)

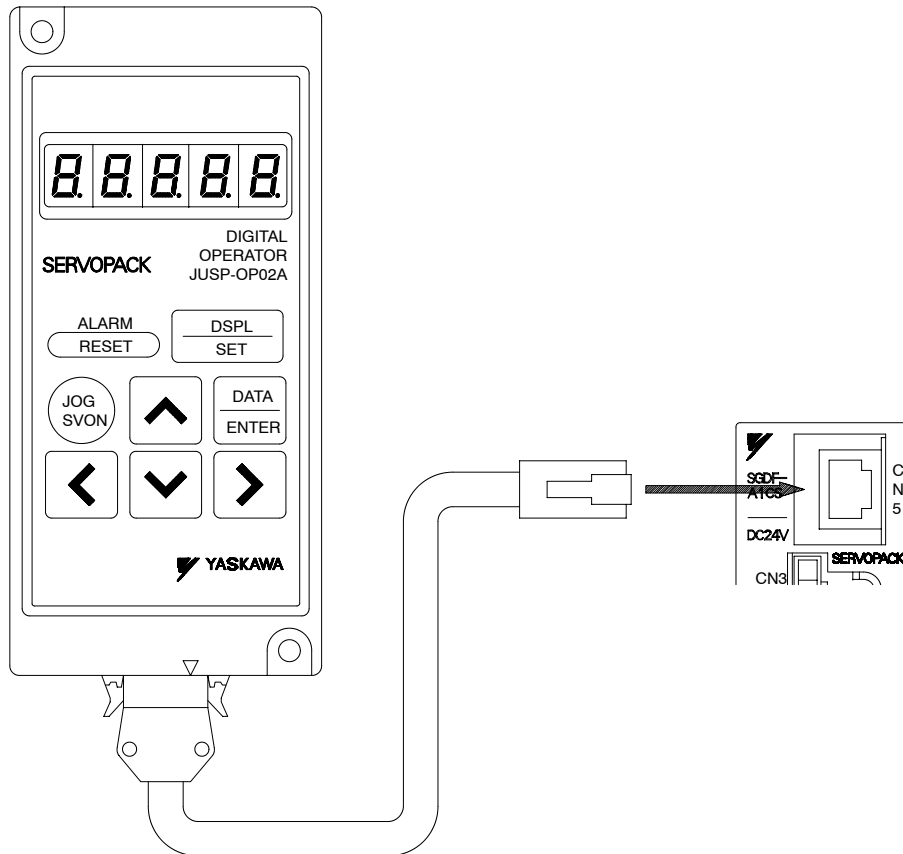

3.1.2 Resetting Servo Alarms

Servo alarms can be reset using the Digital Operator. (Servo alarms can also be reset by the CN1-2, /ALMRST input signal. Refer to 2.7.1 *Servo Alarm Output* for details.)

If the power is turned OFF after a servo alarm has occurred, there is no need to reset the alarm.

After an alarm occurs, remove the cause of the alarm before resetting it. Refer to 5.2 *Troubleshooting* to determine and remedy the cause of an alarm.

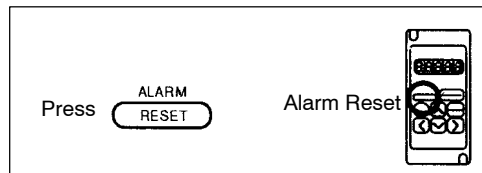

3.1.3 Basic Functions and Mode Selection

The Digital Operator supports status display, parameter setting, operating reference, and autotuning operations.

The four basic modes are listed below. Each time the mode key is pressed, the next mode in the sequence is selected.



Press the



key to switch the mode.

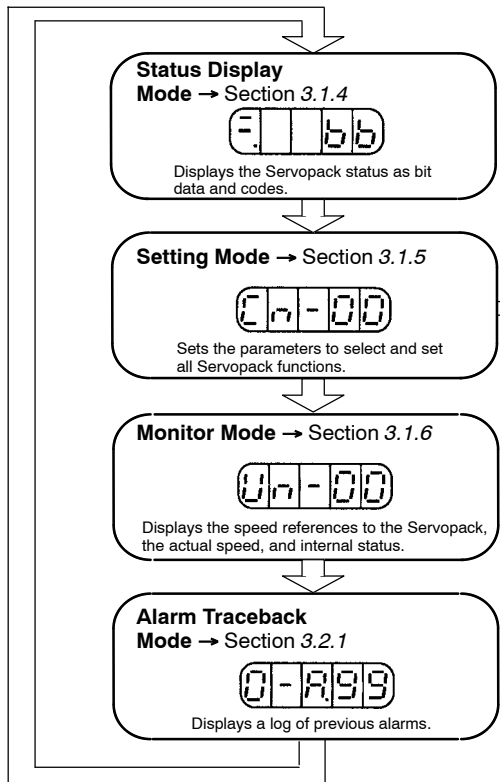

Special Modes

These modes are selected by setting a value for parameter **Cn-00**

Cn-00 Setting	Mode
00-00	Operation mode from Digital Operator → Section 3.2.2
00-01	Reference offset automatic adjustment mode → Section 3.2.4
00-02	Clear alarm traceback data → Section 3.2.6
00-03	Speed reference offset manual adjustment mode → Section 3.2.5
00-04	Motor-type check mode → Section 3.2.7
00-05	Autotuning mode → Section 3.2.3
00-06	Software-version check mode → Section 3.2.8

3

3.1.4 Operation in Status Display Mode

The status display mode displays the Servopack status as bit data and codes.

Selecting Status Display Mode

The status display mode is displayed when the power supply is turned ON. If the status display mode is not displayed, follow the procedure in 3.1.3 Mode Selection to select the status display mode.

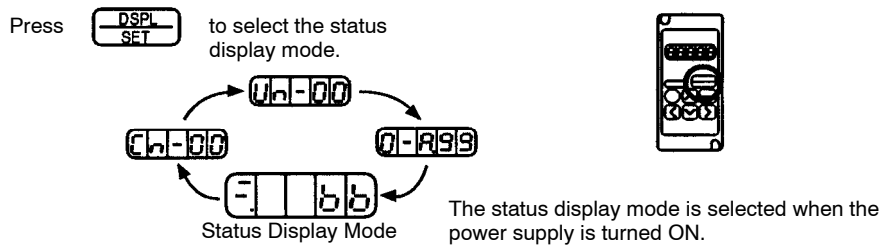

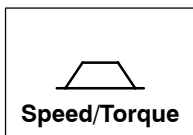

Meaning of Status Displays

Keys to the status display are shown below. The display differs between Servomotors for speed/torque control and position control.

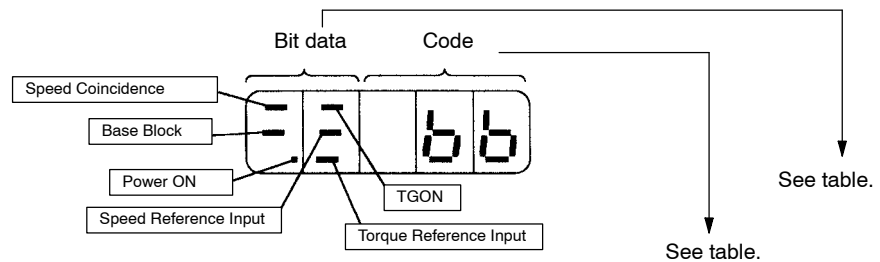

Speed/Torque Control

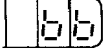
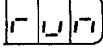
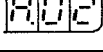

Code	Status
	Base block Servo OFF (motor power OFF)
	Run Servo ON (motor power ON)
	Alarm Status Displays the alarm number. See the table of alarms on page 3-14.
	

Bit Data	Description
Power ON	Lit when Servopack power ON. Not lit when Servopack power OFF.
Base Block	Lit for base block. Not lit at servo ON.
Speed Coincidence	Lit if motor speed reaches speed reference. Otherwise, not lit.
/TGON	Lit if motor speed exceeds preset value. Not lit if motor speed is below preset value. Preset value: Set in Cn-0B (20 min ⁻¹ is factory setting)
Speed Reference Input	Lit if input speed reference exceeds preset value. Not lit if input speed reference is below preset value. Specified value: Set in Cn-0B (20 min ⁻¹ is factory setting)
Torque Reference Input	Lit if input torque reference exceeds preset value. Not lit if input torque reference is below preset value. Preset value: Set in Cn-0B (10% rated torque is standard setting)

3

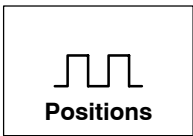

Position Control

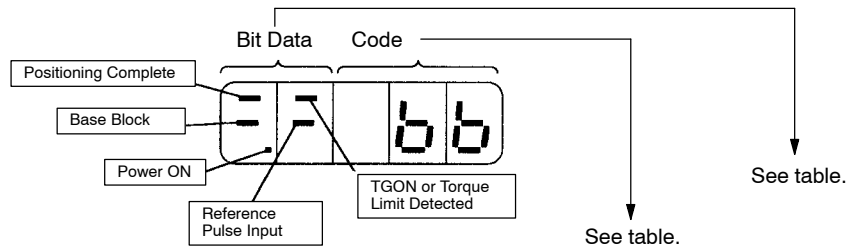

Code	Status
	Base block Servo OFF
	Run Servo ON
	Alarm Status Displays the alarm number. See the table of alarms on page 3-14.

Bit Data	Description
Power ON	Lit when Servopack power ON. Not lit when Servopack power OFF.
Base Block	Lit for base block. Not lit at servo ON.
Positioning Complete	Lit if error between position reference and actual motor position is below preset value. Not lit if error between position reference and actual motor position exceeds preset value. Preset value: Set in Cn-1B (1 pulse is standard setting)
/TGON	Lit if motor speed exceeds preset value. Not lit if motor speed is below preset value. Preset value: Set in Cn-0B (20 min ⁻¹ is standard setting)
Reference Pulse Input	Lit if reference pulse is input. Not lit if no reference pulse is input.

3.1.5 Operation in Parameter Setting Mode

Parameters are used to select and adjust various functions. Two types of parameter are used as follows:

- Constant Settings (Cn-03 to Cn-2C)
- Memory Switches (Cn-01, Cn-02)

The setting method is different for each type. The constant settings (Cn-03 to Cn-2C) allow setting of a constant within a fixed range. The memory switches (Cn-01, Cn-02) allow the required functions to be selected. Refer to *Appendix C List of Parameter Settings*.





Changing the Constant Settings (Cn-03 to Cn-2C)

The constant settings (Cn-03 to Cn-2C) allow setting of a constant within a fixed range. Check the permitted range of the constant in *Appendix C List of Parameter Settings*, before changing the data. The following example shows how to change user setting Cn-15 from 100 to 85.

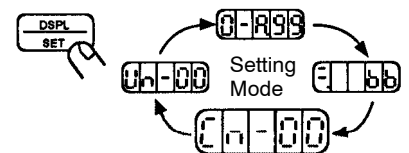

- 1) Press  to select the parameter setting mode.





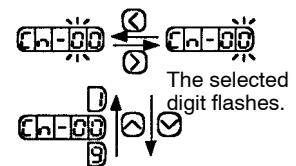

- 2) Select the parameter number to set.
Press the  and  keys to select the digit.
Press the  and  keys to change the value.



- 3) Press  to display the current data for the parameter selected at step 2.



- 4) Set the required data.
Press the  and  keys to select the digit.
Press the  and  keys to change the value.

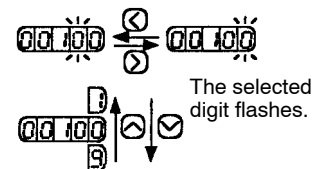

- 5) Press  to store the data.

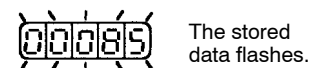

- 6) Press  once more to display the parameter number again.



- 7) Repeat steps 2 to 6 as often as required.

Changing the Memory Switch Settings (Cn-01, Cn-02)

The bits of the memory switches can be turned ON and OFF to select the functions required. The following example shows how to turn ON bit 4 of memory switch Cn-02.

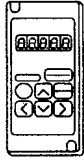

1) Press **DSPL SET** to select the parameter setting mode.

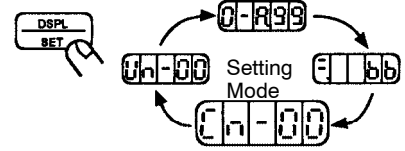

2) Select the parameter number to set.
Press the **<** and **>** keys to select the digit.
Press the **^** and **v** keys to change the value.

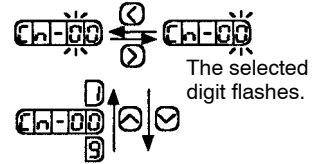

3) Press **DATA ENTER** to display the current data for the memory switch selected at step 2.

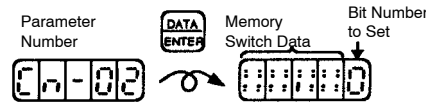

4) Press the **<** and **>** keys to select the bit number to set.

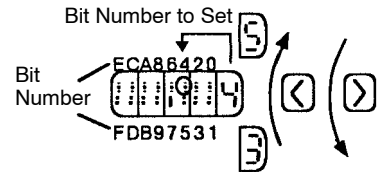

5) Press the **^** and **v** keys to set the memory switch data ON or OFF for the bit number.

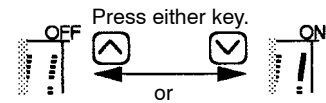

6) Repeat steps 4 and 5 as often as required.

7) Press **DATA ENTER** to store the data.



8) Press **DATA ENTER** once more to display the parameter number again.



Turning bits ON and OFF

Memory switches use bits, not numbers, to select functions.

Sixteen bits are available (0 to 9 and A to F). Select the required functions by turning the appropriate bit ON (function ON) or OFF (function OFF).

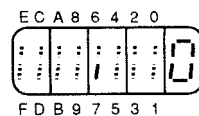

: = OFF
| = ON

3.1.6 Operation in Monitor Mode

The monitor mode allows the reference values input into the Servopack, I/O signal status, and Servopack internal status to be monitored.

The monitor mode can be set during motor operation.

Using Monitor Mode

The example below shows how to display 1500, the contents of monitor number Un-00.

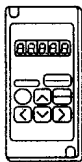

1) Press **DSPL SET** to select monitor mode.

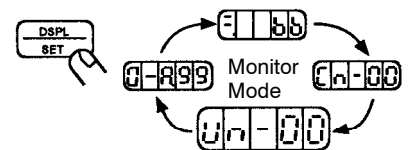

2) Press the **▲** and **▼** keys to select the monitor number to display.

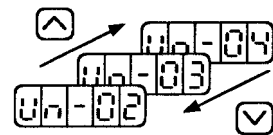

3) Press **DATA ENTER** to display the data for the monitor number selected at step 2.



4) Press **DATA ENTER** once more to display the monitor number again.



Meaning of Monitor Mode Display

Keys to Monitor Mode Displays are shown in the following table.

The display differs between the speed/torque control and position control.

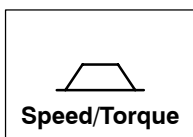

Speed/Torque Control

Monitor Number	Monitor Display
Un-00	Actual motor speed Units: min ⁻¹ .
Un-01	Input speed reference Units: min ⁻¹ .
Un-02	Internal torque reference Units: % (with respect to rated torque)
Un-03	Number of pulses from motor U-phase edge Units: pulses
Un-04	Electrical angle Units: deg
Un-05	Internal status bit display

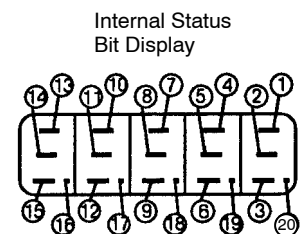

See following table.

USING THE DIGITAL OPERATOR

3.1.6 Operation in Monitor Mode cont.

Bit #	Description	Related I/O Signal, Parameter
1	Servo alarm	ALM
2	Not used.	---
3	Reverse rotation mode	Cn-02 bit 0
4	During motor rotation	/TG-ON, status display mode
5	Speed coincidence	/V-CMP, status display mode
6	Mode switch ON	---
7	During forward current limit or contact input speed control	/CL
8	Not used	---
9	Motor power ON	---
10	Phase A	PA, /PA
11	Phase B	PB, /PB
12	Phase C	PC, /PC
13	Phase U	---
14	Phase V	---
15	Phase W	---
16	Servo ON	/S-ON, Cn-01 bit 0
17	P operation, zero-clamp, or rotation direction input	/P-CON, Cn-01 bit A, B, Cn-02 bit 2
18 to 20	Not used	---



Position Control

Monitor Number	Monitor Display
Un-00	Actual motor speed Units: min ⁻¹ .
Un-02	Internal torque reference Units: % (with respect to rated torque)
Un-03	Number of pulses from motor U-phase edge Units: pulses
Un-04	Electrical angle Units: deg
Un-05	Internal status bit display
Un-06	Internal status bit display
Un-07	Input reference pulse speed display Units: min ⁻¹ .
Un-08	Positional error Units: x1 reference unit (Cn-02 bit E = 0) x100 reference unit (Cn-02 bit E = 1)
Un-09	Reference pulse count value 0 to 65535 Units: reference unit

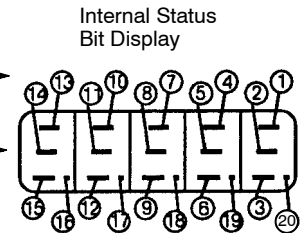

See following table.

Monitor #	Bit #	Description	Related I/O Signal, Parameter
Un-05	1	Servo alarm	ALM
	2	Not used	---
	3	Reverse rotation mode	Cn-02 bit 0
	4	During motor rotation	/TGON, status display mode
	5	Positioning complete	/COIN, status display mode
	6	Mode switch ON	---
	7	During forward current limit or contact input speed control	/CL
	8	Not used	---
	9	Motor power ON	---
	10	Phase A	PA, /PA
	11	Phase B	PB, /PB
	12	Phase C	PC, /PC
	13	Phase U	---
	14	Phase V	---
	15	Phase W	---
	16	Servo ON	/S-ON, Cn-01 bit 0
	17	P operation input, zero-clamp, or rotation direction	/P-CON, Cn-01 bit A, B, Cn-02 bit 2
	18 to 20	Not used	---

USING THE DIGITAL OPERATOR

3.1.6 Operation in Monitor Mode cont.

Monitor #	Bit #	Description	Related I/O Signal, Parameter
Un-06	1	Input reference pulse	PLUS, /PULS
	2	Input pulse sign	SIGN, /SIGN
	3	Error counter clear input	CLR, /CLR
	4 to 20	Not used	---

3.2 Applications

This section describes the applications of the Digital Operator's basic operations for operating and adjusting the motor. Be sure to read 3.1 Basic Operations before reading this section.

3.2.1 Operation in Alarm Traceback Mode

The alarm traceback mode displays up to ten alarms that occurred previously. Allowing confirmation of what alarm occurred when, is a useful aid to speed up troubleshooting.

The alarm traceback data is not cleared when the alarm is reset or when the Servopack power is turned OFF. The alarm traceback data does not prevent the Servopack from operating properly. Use the special operation to clear alarm traceback data to clear the data. Refer to 3.2.6 Clearing Alarm Traceback Data for details.

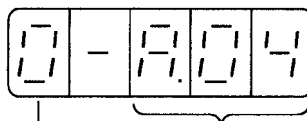

Alarm Sequence Number
The higher the number,
the older the alarm data

Alarm Code

See the table of
alarms on page 3-14.

Alarm Confirmation

Use the following procedure to determine which alarms occurred previously.

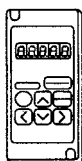

- 1) Press to select the alarm traceback mode.

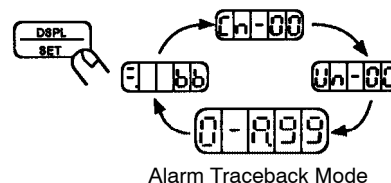

- 2) Press the and keys to scroll the alarm sequence numbers up and down and display information on previous alarms. The higher the left-hand digit (alarm sequence number), the older the alarm data.

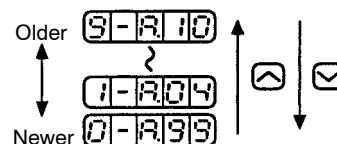

Alarm Display

The following table lists the alarms displayed in the alarm traceback mode.

Refer to 5.2 *Troubleshooting* for further details.

Displayed Alarm Code	Description
R02	Parameter breakdown
R04	Parameter setting error
R10	Overcurrent
R31	Position error pulse overflow (for position control only)
R51	Overspeed
R70	Overload
R80	Encoder error
Rb1	Reference input read error
Rc1	Servo overrun detected (This function prevents overruns.)
Rc2	Encoder output phase error
Rc3	Encoder phase-A, -B disconnection
Rc4	Encoder phase-C disconnection
R99	Not an alarm. Reset by alarm reset or Servopack power ON.

The following are operator-related alarms which are not recorded by alarm traceback.

CPFD0	Digital Operator transmission error 1
CPFD1	Digital Operator transmission error 2

3.2.2 Operation Using the Digital Operator

Operation from the Digital Operator enables the Servopack to run the motor. The Digital Operator can be used during machine set-up and testing to check the motor rotation direction and set the speed, without having to connect a host controller.

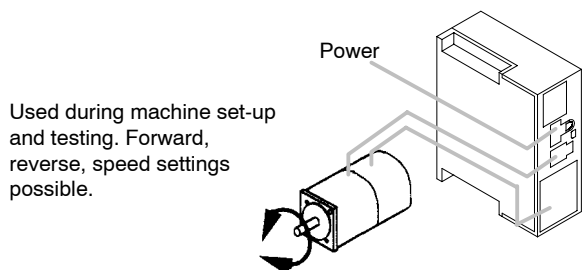

Used during machine set-up and testing. Forward, reverse, speed settings possible.

No need to connect to host controller or external circuits.

Operation Using the Digital Operator

Use the following procedure to operate the motor from the Digital Operator.

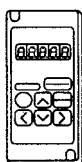

- 1) Press to select the parameter setting mode.

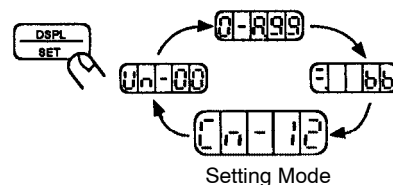

- 2) Select the parameter number Cn-00. (Parameter Cn-00 is selected when the power is turned ON.)

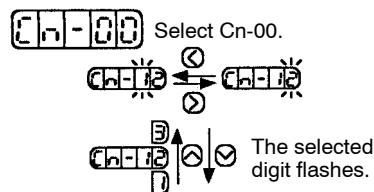

Press the and keys to select the digit.

Press the and keys to change the value.

- 3) Press to display the current data for the parameter Cn-00.

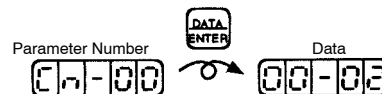

- 4) Press the and keys to change the data to 00. (This parameter is set to 00 when the power is turned ON.)

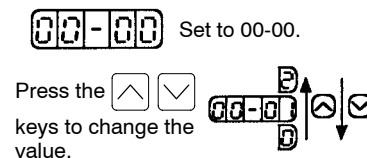

- 5) Press to set the Digital Operator in operation mode. Operation is now possible under Digital Operator control.

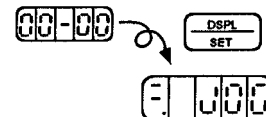

Display for operation mode from Digital Operator

3

- 6) Press  to set the servo ON status (motor power turned ON).

Select Servo ON/Servo OFF

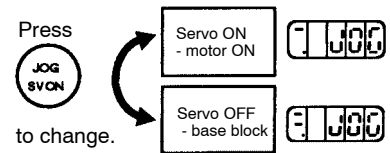

- 7) Press the  and  keys to operate the motor.

Motor Forward/Reverse Rotation

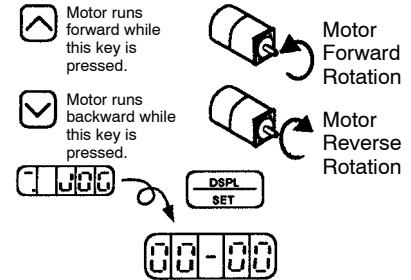

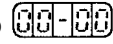
- 8) Press  to revert to . This sets the servo OFF status (motor power turned OFF).

(Alternatively, press  to set the servo OFF status.)

- 9) Press  to return to the setting mode display. This disables operation under Digital Operator control.

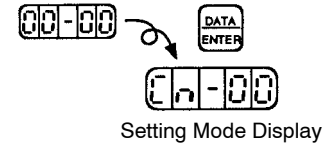

Changing Motor Speed

The motor speed for operation under Digital Operator control can be changed with the following parameter.

Parameter: Cn-10 (JOGSPD), Units: min⁻¹., Standard setting: 500

For details about setting the motor speed, refer to 3.1.5 Operation in Parameter Setting Mode and Appendix C List of Parameters.

3.2.3 Autotuning

The Servopack contains a built-in autotuning function to automatically measure the machine characteristics (machine configuration and rigidity) and set the parameters.

Autotuning allows even totally inexperienced people to easily complete tuning.

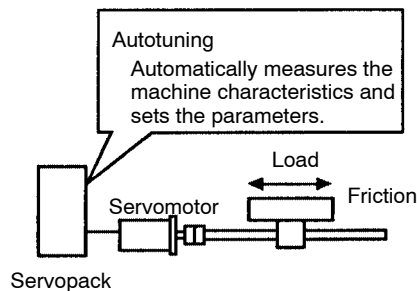

 Autotuning is similar to auto-focus for a camera.

Automatically Settable Parameters

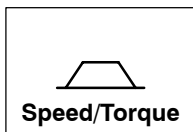

Speed/torque control

Cn-04	Speed loop gain
Cn-05	Speed loop integration time constant

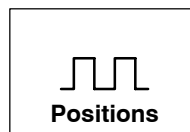

Position control

Cn-04	Speed loop gain
Cn-05	Speed loop integration time constant
Cn-1A	Position loop gain

Once autotuning has been completed, the autotuning procedure can be omitted for subsequent machines, providing the machine specifications remain unchanged.

It is sufficient to directly set the parameters for subsequent machines.

The **machine rigidity** can be selected from one of seven levels.

- Note**
- (1) Conduct autotuning with the motor attached to the machine.
Make sure that the machine is ready for operation and take sufficient safety precautions when operating the machine.
 - (2) Make sure that the /P-CON signal is OFF (PI control is selected) before starting autotuning.
 - (3) Make sure that the speed control mode is set to PI control before starting autotuning.
If the mode switch is used, PI control automatically switches to P control above a set operating level (PI control to P control switching level), even if the /P-CON signal is OFF.
If the mode switch is used, perform one of the following operations before starting autotuning.
 - Set the parameters to disable the mode switch.
Speed control: Set both Cn-01 bit C and bit D to 1.
Position control: Set both Cn-01 bit B to 1.
 - Increase the operating level (PI control to P control switching level), so that P control is not selected.
In practice, set the operating level as shown in the following table.
Select the operating level using bit C and bit D of Cn-01.



Machine Rigidity

The machine rigidity is one of the machine characteristics related to servo control. Set the servo to high response for a machine with high rigidity, such as a machine tool, and to low response for a machine with low rigidity, such as a robot.

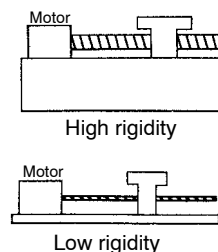

Operating Level	Parameter Setting
Torque reference	Cn-0C to maximum torque
Speed reference	Cn-0D to a preset value exceeding Cn-10
Acceleration	Cn-0E to the maximum value: 3000
Error pulse	Cn-0F to the maximum value: 10000

Using Autotuning

Follow the procedure below to run autotuning.

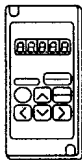

3

- 1) Press to select the parameter setting mode.

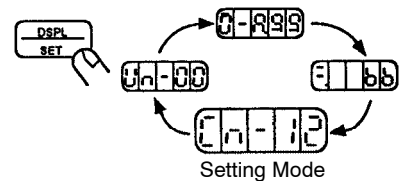

- 2) Select the parameter number Cn-00.
(Parameter Cn-00 is selected when the power is turned ON.)

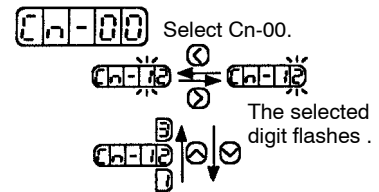

Press the and keys to select the digit.

Press the and keys to change the value.

- 3) Press to display the current data for the parameter Cn-00.

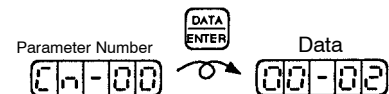

- 4) Press the and keys to change the data to 05.

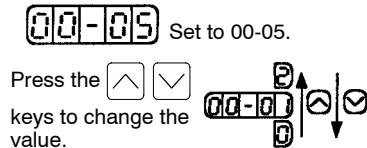

- 5) Press to display the machine rigidity.

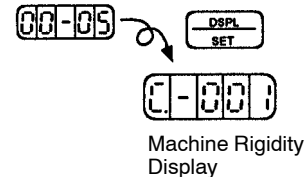

- 6) Press the and keys to select the machine rigidity. If the actual rigidity is unknown, select medium rigidity.

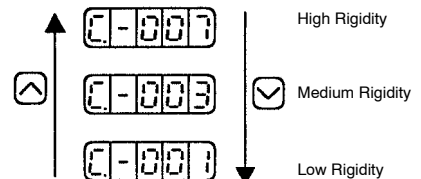

- 7) Press to select autotuning mode.

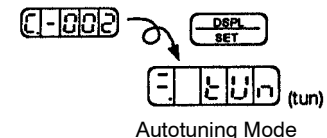

- 8) Press the  key to set the servo ON status.

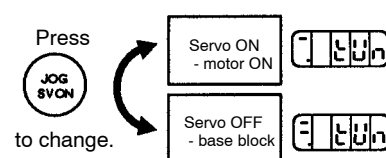

Select Servo ON/Servo OFF

- 9) Press the  and  keys to operate the motor.

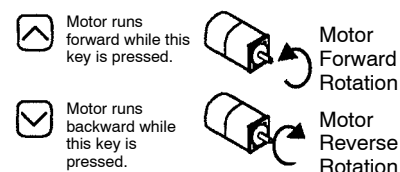

Motor Forward/Reverse Rotation

- 10) When autotuning is complete, the END message is displayed, as shown to the right. Servo OFF status is automatically selected. If Servo ON/Servo OFF is selected by a signal from an external contact, turn this signal OFF.

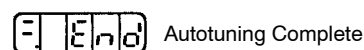

- 11) Release the  and  keys to revert to the  display.



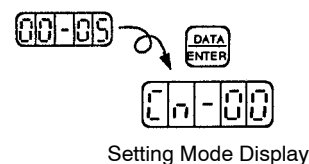

- 12) Press the  key to return to the setting mode display. This ends the autotuning operation.



Autotuning Precautions

Speed Setting During Autotuning

The motor speed during autotuning is set by parameter Cn-10. Set to 500 min⁻¹, which is the factory setting. Autotuning may be unsuccessful if this value is set too low.

The motor runs intermittently while the  or  key is held down. The motor does not rotate continuously.

Machine Rigidity Selection



Select the machine rigidity as described below. If the actual rigidity is unknown, select medium rigidity.



 High Rigidity

 Medium Rigidity

 Low Rigidity



- If the Machine Resonates

At servo ON when the  key is pressed or when the motor is operated by pressing the  or  key, machine resonance indicates an inappropriate machine rigidity setting. Use the following procedure to correct the machine rigidity setting, and run autotuning once more.

- (1) Press the  key to cancel autotuning.
- (2) Press the  key once more to enter the machine rigidity setting mode. Reduce the setting by one.

- If Autotuning Does Not End

Failure of autotuning to end , is caused by an inappropriate machine rigidity setting. Use the following procedure to correct the machine rigidity setting, and run autotuning once more.

- (1) Press the  key to cancel autotuning.
- (2) Press the  key once more to enter the machine rigidity setting mode. Increase the setting by one.

Autotuning may not end for machines with large play or extremely low rigidity. In these cases, use conventional manual adjustment.

Input Signals

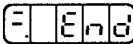
- Set the /P-CON signal to OFF during autotuning.
- If the mode switch is used, take one of the steps below before running autotuning. Refer to 2.6.6 Mode Switch for details.
 - Cancel the mode switch.
 - Set the mode switch operating level to a high level.
- If using the /S-ON signal to set the servo ON status, wait until  is displayed before turning ON the /S-ON signal.

3.2.4 Reference Offset Automatic Adjustment

When a Servomotor for speed/torque control is used, the motor may rotate slowly when the reference voltage is intended to be 0 V. This occurs when the host controller or external circuit has a small offset (measured in mV) in the reference voltage.

The reference offset automatic adjustment mode automatically measures the offset and adjusts the reference voltage. It adjusts both speed and torque references.

The Servopack will automatically adjust an offset in the reference voltage from the host controller or external circuit, as shown in the following diagram.

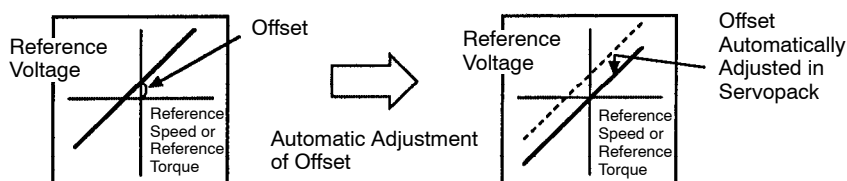

After completion of offset automatic adjustment, the amount of offset is stored in the Servopack.

The amount of offset can be checked in the speed reference offset manual adjustment mode. Refer to 3.2.5 *Reference Offset Manual Adjustment* for details.

The reference offset automatic adjustment mode cannot be used if the error pulses are set to zero when the servo lock is stopped and a positioning loop is formed with the host controller.

Under these conditions, use the reference offset manual adjustment mode. Refer to 3.2.5 *Reference Offset Manual Adjustment Mode* for details.

The motor can be forced to a stop when the speed reference is zero by using the zero-clamp speed control function. Refer to 2.4.2 *Zero-clamp* for details.

Reference Offset Automatic Adjustment Procedure

Use the following procedure to automatically adjust the reference offset.

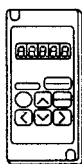

- 1) Set the motor to operating mode as follows:

Input the (intended) 0 V reference voltage from the host controller or external circuit.

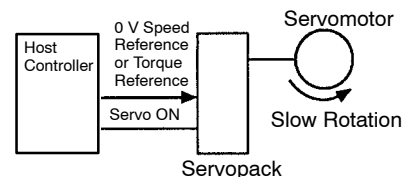

Turn ON the servo ON (/S-ON) signal.

3

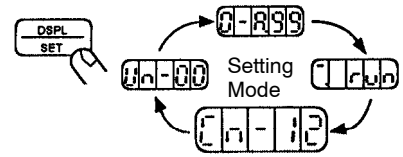

2) Press  to select the parameter setting mode.

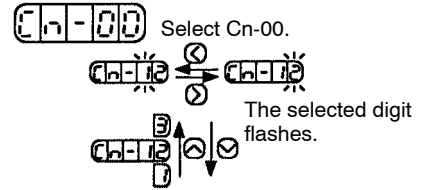

3) Select the parameter number Cn-00. (Parameter Cn-00 is selected when the power is turned ON.)



Press the  and  keys to select the digit.

Press the  and  keys to change the value.

4) Press  to display the current data for the parameter Cn-00.

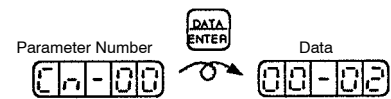

5) Press the  and  keys to change the data to 01.

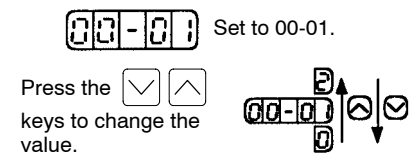

6) Press  to automatically adjust the reference offset. The motor rotation stops.

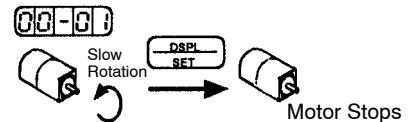

7) Press  to return to the setting mode display. This ends reference offset automatic adjustment.

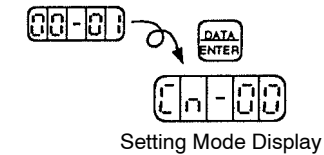

3.2.5 Reference Offset Manual Adjustment

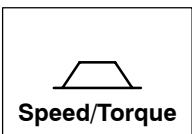

Speed reference offset manual adjustment is available for speed/torque control. It is very convenient in the following situations:

- If a position loop is formed with the host controller and the error pulses are zeroed when servo lock is stopped.
- To deliberately set the offset to specific value.

This mode can also be used to check the data set in the reference offset automatic adjustment mode.

In principle, this mode operates in the same way as the reference offset automatic adjustment mode, except that the amount of offset is directly input during the adjustment. The offset can be set for speed references only.

The offset adjustment range and setting units are as follows:

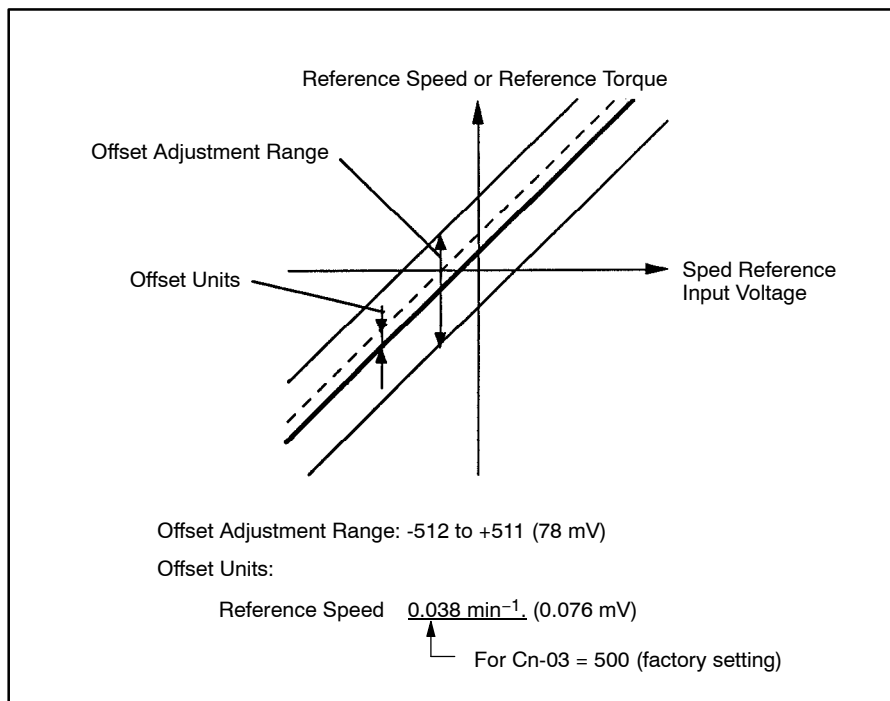

3

Follow the procedure below to manually adjust the reference voltage.

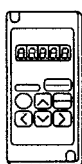

- 1) Press to select the parameter setting mode.

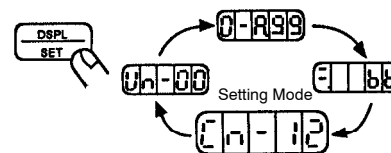

- 2) Select the parameter number Cn-00. (Parameter Cn-00 is selected when the power is turned ON.)

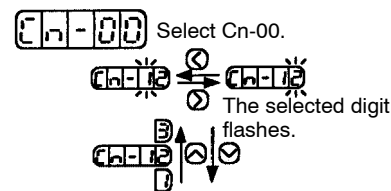

Press the and keys to select the digit.



Press and keys to change the value.

- 3) Press to display the current data for the parameter Cn-00.

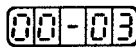

- 4) Press the  and  keys to change the data to 03.



 Set to 00-03.

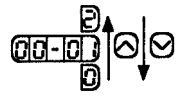

Press the   keys to change the value.

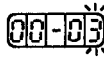

- 5) Press  to select the speed reference offset manual adjustment mode.

(The amount of speed reference offset is displayed.)



 
Speed Reference Offset Manual Adjustment Mode 

- 6) Press the  and  keys to adjust the amount of offset.

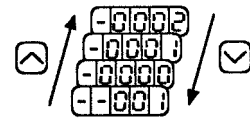

(Adjust the speed references.)

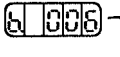

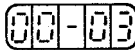
- 7) Press  to return to the parameter data display.

- 8) Press  to return to the setting mode display. This ends the reference offset manual adjustment.

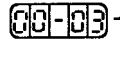

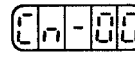
Setting Mode Display

3

3.2.6 Clearing Alarm Traceback Data

The following procedure is used to clear the alarm history, which stores the alarms occurring in the Servopack. Each alarm in the alarm history is set to A.99, which is not an alarm code. Refer to 3.2.1 *Operation in Alarm Traceback Mode* for details.

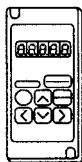
Use the following procedure to clear the alarm traceback data.



- 1) Press  to select the parameter setting mode.

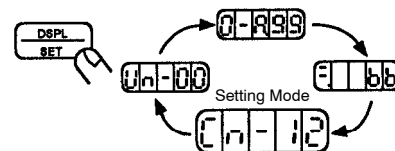

- 2) Select the parameter number Cn-00.
(Parameter Cn-00 is selected when the power is turned ON.)

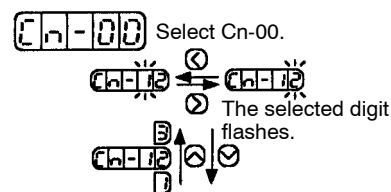

Press the  and  keys to select the digit.

Press the  and  keys to change the value.

- 3) Press  to display the current data for the parameter Cn-00.

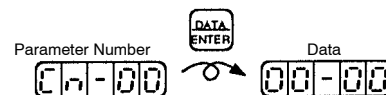

- 4) Press the  and  keys to change the data to 02.

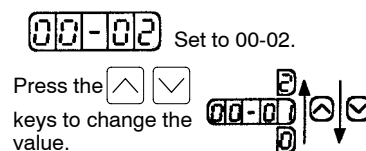

- 5) Press  to clear the alarm traceback data.

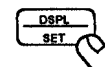

Clear the alarm traceback data.

- 6) Press  to return to the parameter data display.

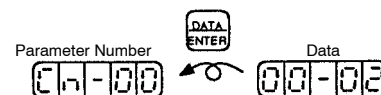

3.2.7 Checking Motor Type

This mode is used for maintenance. Set Cn-00 to 00-04 to select the motor-type check mode.

Operation

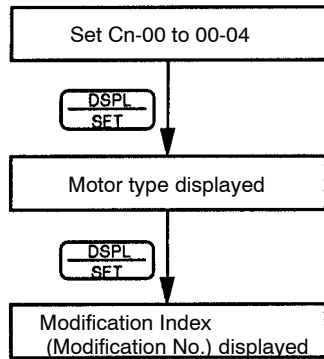

Motor Type Display

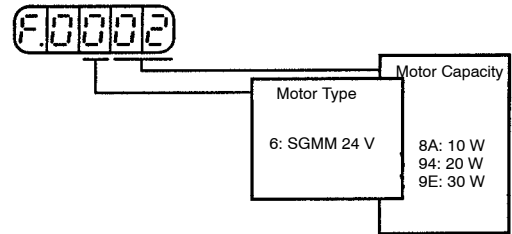

Modification Index (Modification No.) Display



$$\textcircled{1} \times 16^3 + \textcircled{2} \times 16^2 + \textcircled{3} \times 16 + \textcircled{4} = \text{Modification index (Modification No.)}$$

3.2.8 Checking Software Version

This mode is used for maintenance. Set Cn-00 to 00-06 to select the software-version check mode.

Operation

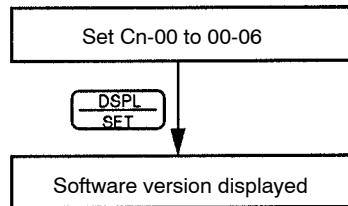

Software Version Display

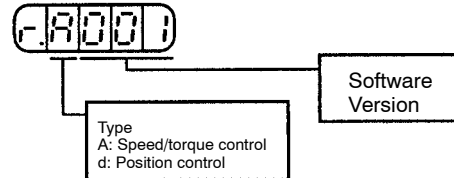

3

SERVO SELECTION AND DATA SHEETS

4

This chapter describes how to select Servo Driver and peripheral devices. The chapter also presents the specifications and dimensional drawings required for selection and design. Choose and carefully read the relevant sections of this chapter.

4.1	Selecting a Servo Drive	4-3
4.1.1	Selecting a Servomotor	4-3
4.1.2	Selecting a Servopack	4-9
4.2	Servomotor Ratings and Characteristics	4-11
4.2.1	Ratings and Specifications	4-11
4.2.2	Mechanical Characteristics	4-16
4.3	Servopack Ratings and Characteristics	4-18
4.3.1	Ratings and Specifications	4-18
4.3.2	Overload Characteristics	4-25
4.3.3	Starting Time and Stopping Time	4-26
4.3.4	Overhanging Loads	4-26
4.3.5	In-rush Current and Power Loss	4-27
4.4	Servo Drive Dimensional Drawings	4-28
4.4.1	Servomotor Dimensional Drawings	4-28
4.4.2	Servomotor Dimensional Drawings: European Safety Standards	4-37
4.4.3	Servopack Dimensional Drawings	4-45
4.4.4	Digital Operator Dimensional Drawings	4-46
4.5	Selecting Peripheral Devices	4-47
4.5.1	Selecting Peripheral Devices	4-47

4.6 Specifications and Dimensional Drawings of Peripheral Devices 4-50

- 4.6.1 Cable Specifications and Peripheral Devices 4-50
- 4.6.2 Motor Cables 4-51
- 4.6.3 Encoder Cables 4-54
- 4.6.4 Connector Kits 4-56
- 4.6.5 Cable with CN1 Connector at One End Only 4-61
- 4.6.6 Circuit Breaker 4-61
- 4.6.7 Noise Filter 4-62
- 4.6.8 Magnetic Contactor 4-62
- 4.6.9 Surge Suppressor 4-64
- 4.6.10 Variable Resistor for Speed Setting 4-64
- 4.6.11 Encoder Signal Converter Unit 4-65
- 4.6.12 Cables for Connecting PC and Servopack 4-67
- 4.6.10 Variable Resistor for Speed Setting 4-64
- 4.6.11 Encoder Signal Converter Unit 4-64
- 4.6.12 Cables for Connecting PC and Servopack 4-66

4.1 Selecting a Servo Drive

■ This section describes how to select a Servomotor, Servopack, and Digital Operator.

4.1.1 Selecting a Servomotor

The selection of a Servomotor matched to the servo system in which it will be used is based on the Servomotor model. The numbers (1) to (6) in the following diagram correspond to the numbers in the Servomotor selection flowchart on the following pages.

Model Details

The seven alphanumeric characters after “SGMM-” indicate the Servomotor model, as described in the following diagram.

- Standard Type

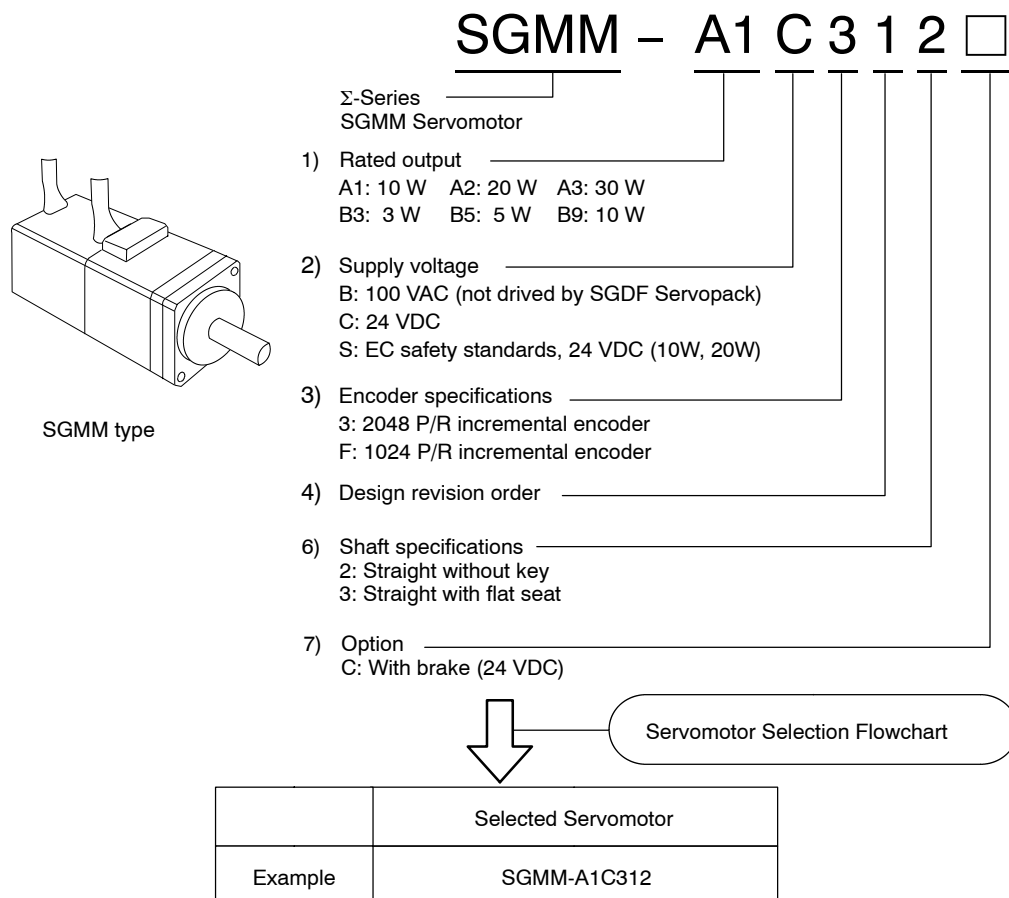

- With Reduction Gears

SGMM – A1 C 3 J A 2

Σ-Series
SGMM Servomotor

- 1) Rated output _____
A1: 10 W A2: 20 W A3: 30 W
B3: 3 W B5: 5 W B9: 10 W
- 2) Supply voltage _____
B: 100 VAC (not driven by SGDF Servopack)
C: 24 VDC
S: EC safety standards, 24 VDC (10W, 20W)
- 3) Encoder specifications _____
3: 2048 P/R incremental encoder
F: 1024 P/R incremental encoder
- 5) With reduction gears _____

Gear ratio _____
A: 1/5 1: 1/5
B: 1/16 2: 1/16
C: 1/25 3: 1/25
 (10 W, 20 W) (30 W)
- 6) Shaft specifications _____
2: Straight without key
6: Straight with key and tap
- 7) Option _____
C: With brake (24 VDC)



Servomotor Selection Flowchart

	Selected Servomotor
Example	SGMM-A1C3JA2

4

Servomotor Selection Flowchart

Use the following flowchart to select a Servomotor.

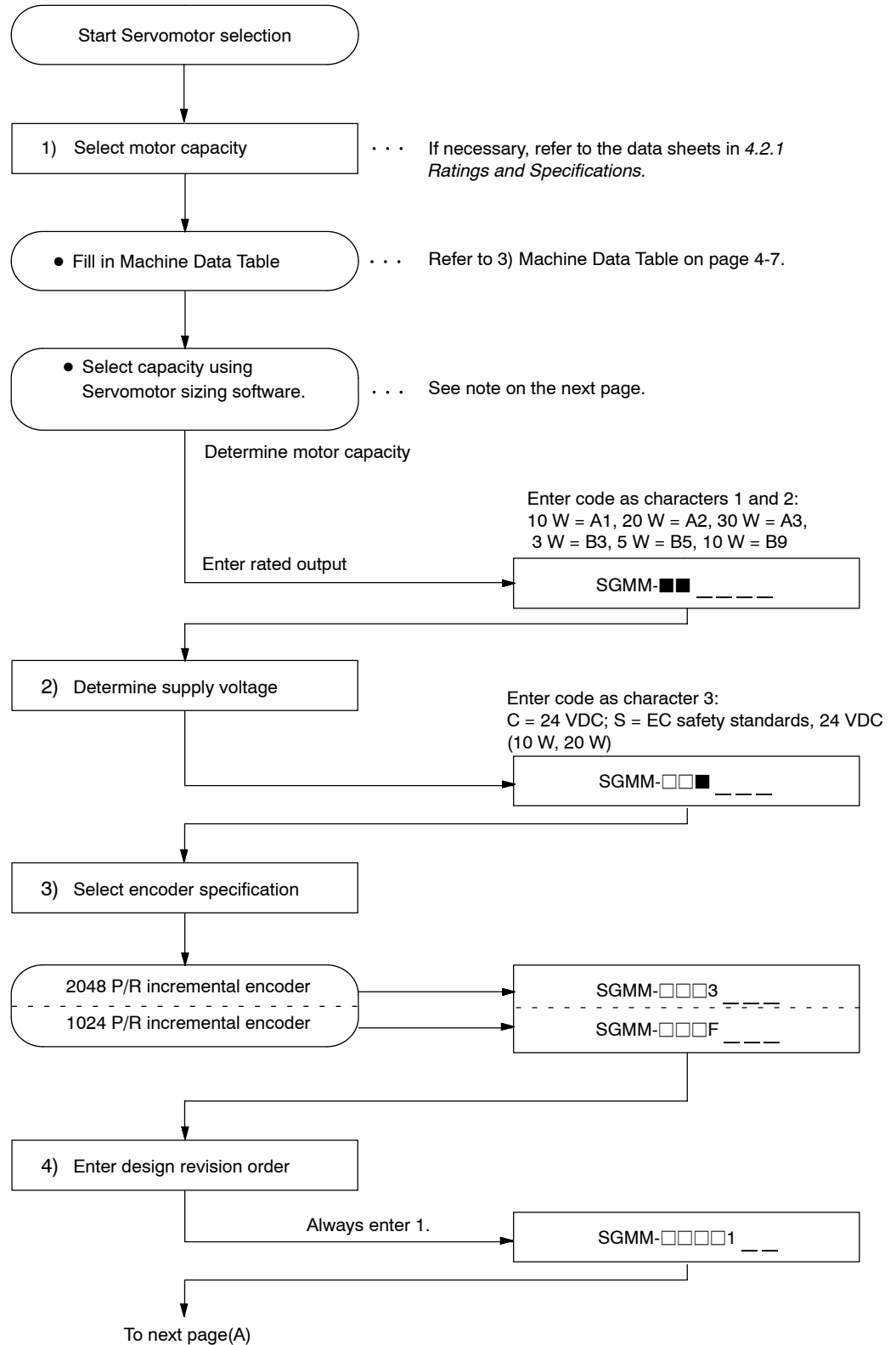

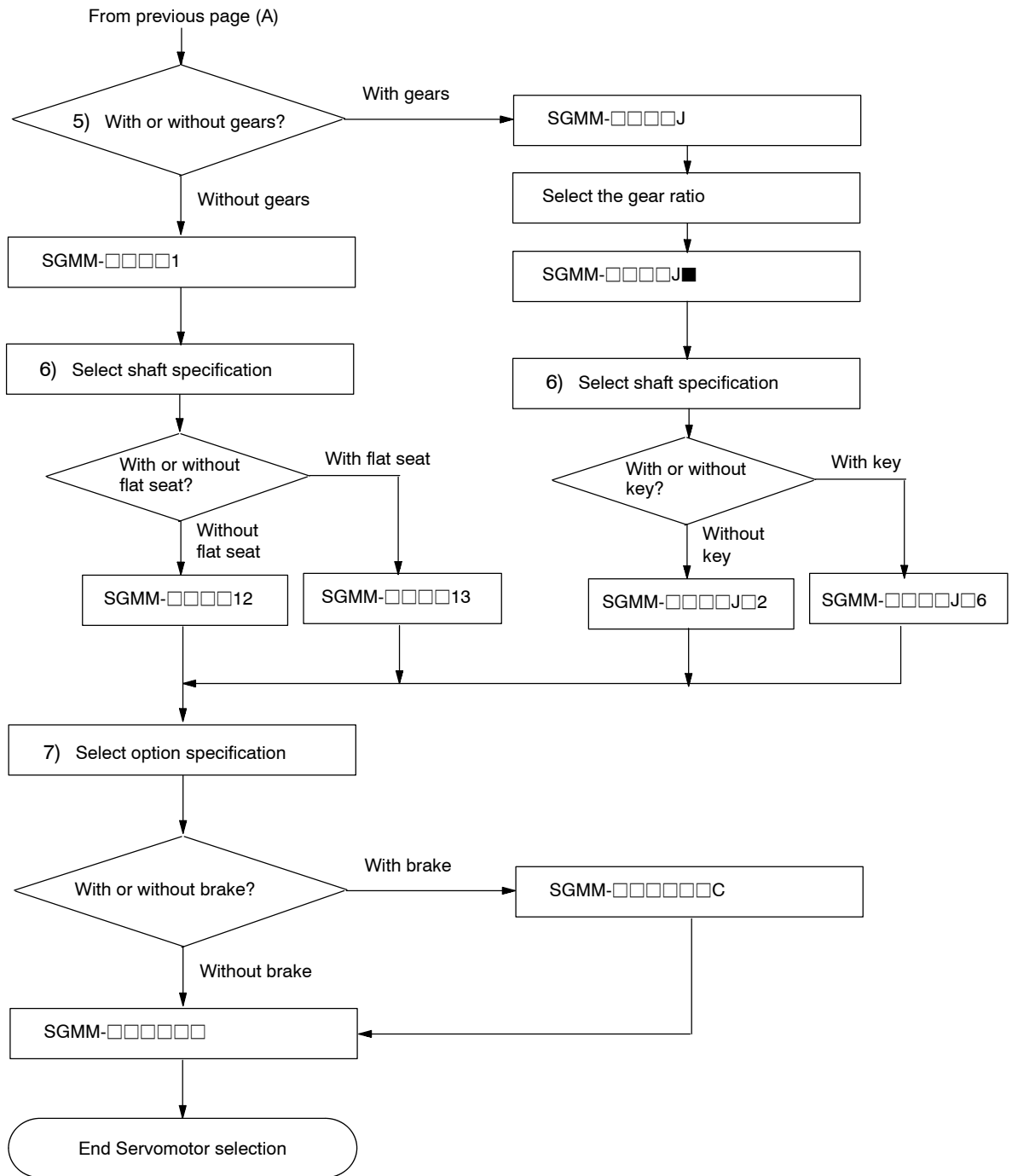

Note Consult a Yaskawa sales representative for details of Servomotor sizing software.

4

Machine Data Table

Fill out the machine data table below as an aid to selecting the drive system. When the machine data table is complete, use the Servomotor sizing software to select the motor capacity.

Ball Screw Horizontal Axis			
Load mass	W	—kg (lb)	
Thrust	F	—N (lb)	
Coefficient of friction	μ	—	
Overall efficiency	η	—	
Gear ratio	R (= Nm/Nl)	—	
Gear+coupling	Jg	—kg·cm ² (lb·in ² .)	
Ball screw pitch	P	—mm (in.)	
Ball screw diameter	D	—mm (in.)	
Ball screw length	L	—mm (in.)	
Ball Screw Vertical Axis			
Load mass	W_1	—kg (lb)	
Counterweight	W_2	—kg (lb)	
Coefficient of friction	μ	—	
Overall efficiency	η	—	
Gear ratio	R (= Nm/Nl)	—	
Gear+coupling	Jg	—kg·cm ² (lb·in ² .)	
Ball screw pitch	P	—mm (in.)	
Ball screw diameter	D	—mm (in.)	
Ball screw length	L	—mm (in.)	
Timing Belt			
Load mass	W	—kg (lb)	
Thrust	F	—N (lb)	
Coefficient of friction	μ	—	
Overall efficiency	η	—	
Gear ratio	R (= Nm/Nl)	—	
Gear+coupling	Jg	—kg·cm ² (lb·in ² .)	
Pulley	Jd	—kg·cm ² (lb·in ² .)	
Pulley diameter	D	—mm (in.)	
Rack and Pinion			
Load mass	W	—kg (lb)	
Thrust	F	—N (lb)	
Coefficient of friction	μ	—	
Overall efficiency	η	—	
Gear ratio	R (= Nm/Nl)	—	
Gear+coupling	Jg	—kg·cm ² (lb·in ² .)	
Pinion diameter	D	—mm (in.)	
Pinion thickness	t	—mm (in.)	

SERVO SELECTION AND DATA SHEETS

4.1.1 Selecting a Servomotor

Roll Feeder			
Load GD ²	$J\ell$	—kg·cm ² (lb·in ² .)	
Tension	F	—N (lb)	
Press force	P	—N (lb)	
Roller diameter	D	—mm (in.)	
Coefficient of friction	μ	—	
Overall efficiency	η	—	
Gear ratio	R (= Nm/NI)	—	
Gear+coupling	J_g	—kg·cm ² (lb·in ² .)	
Rotor			
Load GD ²	$J\ell$	—kg·cm ² (lb·in ² .)	
Load torque	$T\ell$	—N·m (lb.in.)	
Overall efficiency	η	—	
Gear ratio	R (= Nm/NI)	—	
Gear+coupling	J_g	—kg·cm ² (lb·in ² .)	
Others			
Load GD ²	$J\ell$	—kg·cm ² (lb·in ² .)	
Load torque	$T\ell$	—N·m (lb.in.)	
Motor speed	Nm	—min ⁻¹	
DUTY	td	—s	
Positioning time	ts	—s	
Accel/decel time	ta	—s	
Duty cycle			
DUTY	td	—s	
Positioning distance	L_s	—mm (in.)	
Moving member speed	$V\ell$	—m/min	
Positioning time	ts	—s	
Accel/decel time	ta	—s	
Enter either $V\ell$ or ts. If both are entered, specify priority.			
<ul style="list-style-type: none"> ● Operating environment ● Operating temperature ● Other 			

4

4.1.2 Selecting a Servopack

The selection of a Servopack matched to the servo system in which it will be used is based on the Servopack model. The numbers (1) to (2) in the following diagram correspond to the numbers in the Servopack selection flowchart on the following pages.

Model Details

The four alphanumeric characters after “SGDF-” indicate the Servopack model, as described in the following diagram.

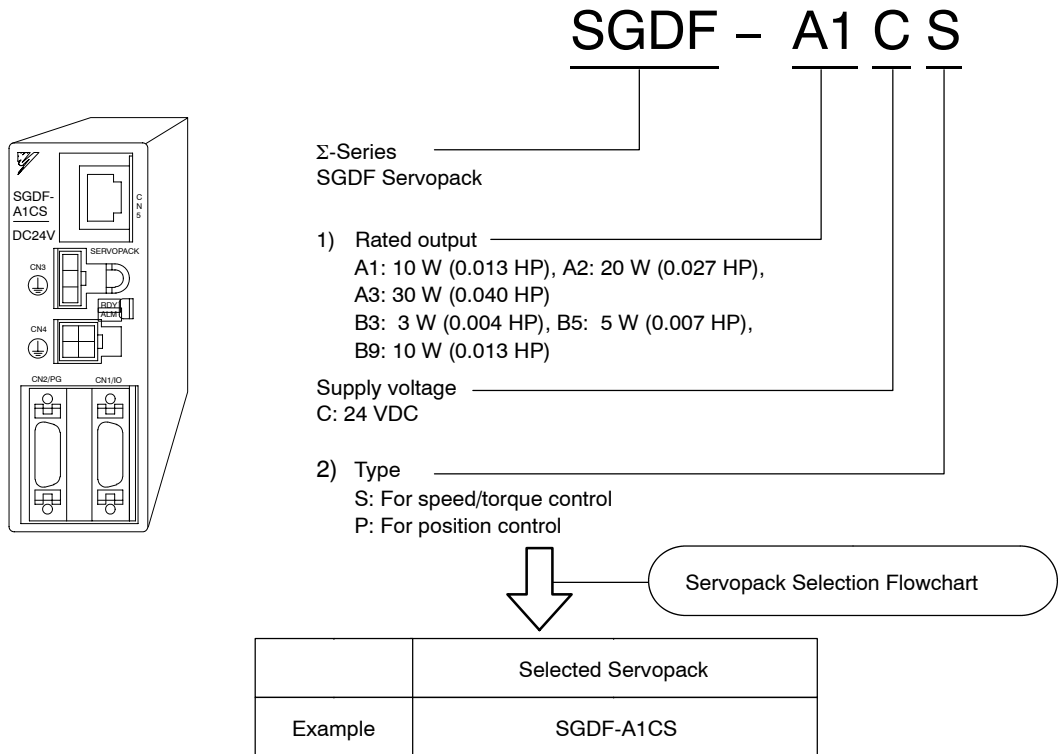

Servopack Selection Flowchart

Use the following flowchart to select a Servopack.

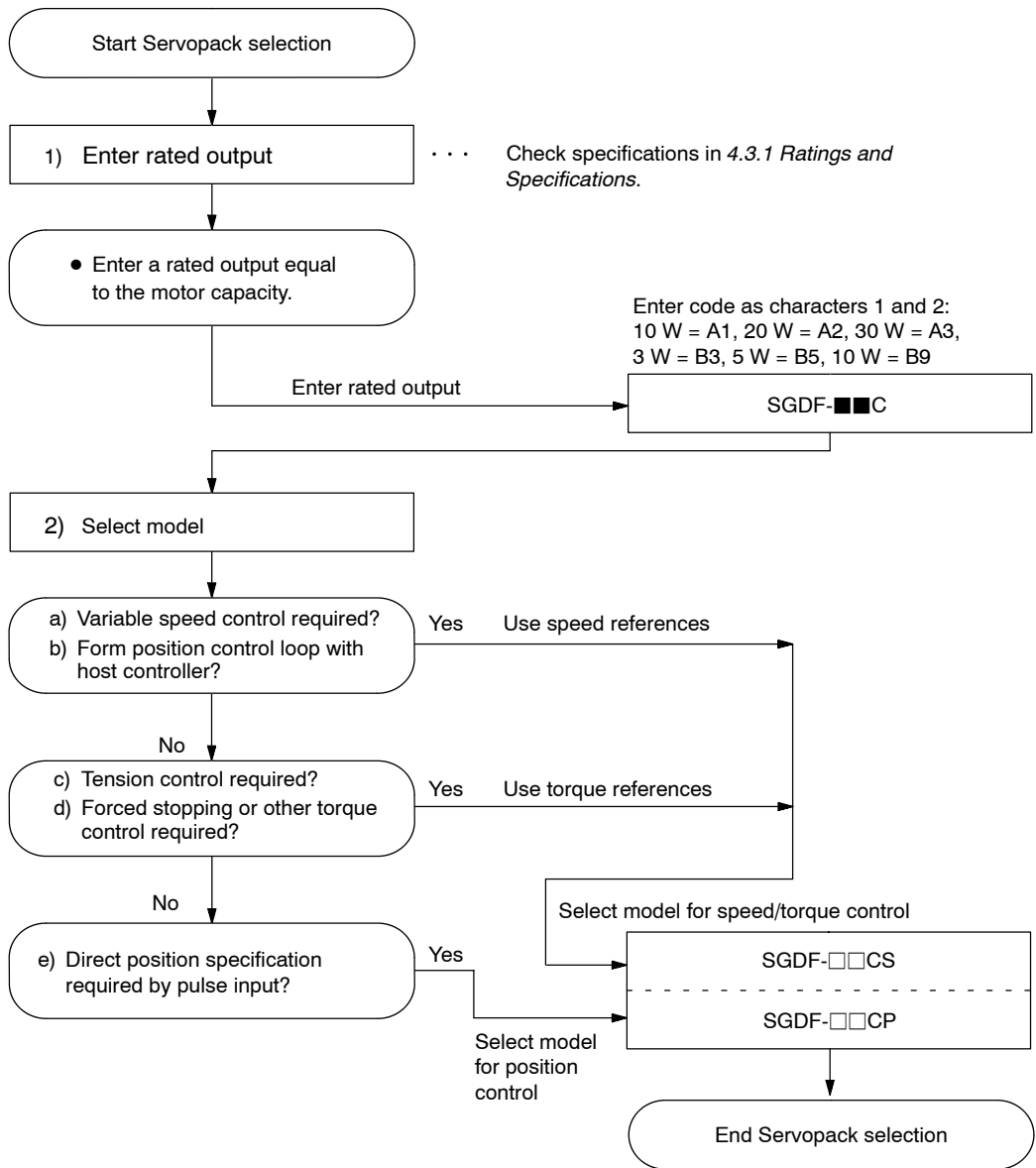

4

4.2 Servomotor Ratings and Characteristics

This section provides tables of ratings, specifications, and machine characteristics for Servomotors. Refer to these tables when selecting a Servo Drive.

4.2.1 Ratings and Specifications

24-VDC Servomotors (□15)

Time rating:	Continuous
Thermal class:	B
Vibration class:	15 μ m or below
Withstand voltage:	550 VAC for one minute
Insulation resistance:	500 VDC 10 M Ω min.
Enclosure:	Totally enclosed, self-cooled
Ambient temperature:	0°C to 40°C
Ambient humidity:	20% to 80% (non-condensing)
Excitation:	Permanent magnet
Drive method:	Direct drive
Mounting:	Flange method

Standard Servomotors

SGMM Servomotor		B3CF1□	B5CF1□	B9CF1□
Rated Output *1	W (HP)	3 (0.004)	5 (0.007)	10 (0.013)
Rated Torque *1	N·m	0.00955	0.0159	0.0318
	oz·in *2	1.35	2.25	4.5
Instantaneous Peak Torque *1	N·m	0.0239	0.0398	0.0796
	oz·in *2	3.39	5.64	11.3
Rated Current *1	A (rms)	1.3	1.3	1.5
Instantaneous Maximum Current *1	A (rms)	3.5	3.6	3.9
Rated Speed *1	min ⁻¹	3000		
Instantaneous Maximum Speed *1	min ⁻¹	6000		
Applicable Encoder	---	1024 P/R Incremental encoder		
Moment of Inertia [$J_M = GD^2_M/4$]	$\times 10^{-4}$ kg·m ²	0.0004	0.0008	0.0022
	($\times 10^{-3}$ oz·in·s ²) *2	0.0057	0.0113	0.0311
Rated Angular Acceleration *1	rad/s ²	239000	199000	145000
Rated Power Rate *1	kW/s	2.3	3.2	4.6

*1 These items and torque-speed characteristics are quoted in combination with an SGDF SERVOPACK at an armature winding temperature of 20°C.

*2 These values are reference values.

Note These characteristics can be obtained when the following heat sink (steel plates) are used for cooling purposes: 150 x 150 x 3 mm (5.91 x 5.91 x 0.12 in.)

24-VDC Servomotors (□25)

Time rating:	Continuous
Thermal class:	B
Vibration class:	15µm or below
Withstand voltage:	1000 VAC for one minute
Insulation resistance:	500 VDC 10 MΩ min.
Enclosure:	Totally enclosed, self-cooled
Ambient temperature:	0°C to 40°C
Ambient humidity:	20% to 80% (non-condensing)
Excitation:	Permanent magnet
Drive method:	Direct drive
Mounting:	Flange method

Standard Servomotors

SGMM Servomotor		A1C31□	A2C31□	A3C31□	
Rated Output *1	W (HP)	10 (0.013)	20 (0.027)	30 (0.040)	
Rated Torque *1	N·m	0.0318	0.0637	0.0955	
	oz·in *3	4.5	9.0	13.5	
Instantaneous Peak Torque *1	N·m	0.0955	0.191	0.2887	
	oz·in *3	13.5	27.0	40.9	
Rated Current *1	A (rms)	2.1	2.0	2.9	
Instantaneous Maximum Current *1	A (rms)	6.0	5.7	8.6	
Rated Speed *1	min ⁻¹	3000			
Instantaneous Maximum Speed *1	min ⁻¹	5000			
Applicable Encoder	---	2048 P/R incremental encoder			
Rotor Moment of Inertia [J _M = GD _M ² /4]	Without Brake	× 10 ⁻⁴ kg·m ²	0.00354	0.00548	0.00689
		(× 10 ⁻³ oz·in·s ²) *3	0.0501	0.0776	0.0976
	With Brake	× 10 ⁻⁴ kg·m ²	0.00479	0.00673	0.00814
		(× 10 ⁻³ oz·in·s ²) *3	0.0678	0.0952	0.1152
Rated Angular Acceleration *1	rad/s ²	90000	120000	122300	
Rated Power Rate *1	kW/s	2.90	7.40	11.4	
Brake (optional) *2	Rated Voltage	V	24 VDC		
	Capacity *3	W	2.0	2.6	---
	Holding Torque	---	Motor rated torque		---

*1 These items and torque-speed characteristics are quoted in combination with an SGDF SERVOPACK at an armature winding temperature of 20°C.

*2 The brake is used as a holding brake (non-excitation operation). It cannot be used to stop the Servomotor.

*3 These values are reference values.

Note These characteristics can be obtained when the following heat sinks (steel plates) are used for cooling purposes:

Model A1 or A2: 150 x 150 x 3 mm (5.91 x 5.91 x 0.12 in.)

Model A3: 250 x 250 x 6 mm (9.84 x 9.84 x 0.24 in.)

Servomotors with Reduction Gears

SGMM Servomotor		A1C3J□			A2C3J□			A3C3J□			
Gear Ratio* ¹	---	1/5	1/16	1/25	1/5	1/16	1/25	1/5	1/16	1/25	
Rated Output	W (HP)	8 (0.01)			16 (0.02)			24 (0.03)			
Rated Torque* ²	N·m	0.127	0.407	0.636	0.255	0.815	1.27	0.382	1.22	1.91	
	oz·in* ⁶	18.1	57.7	90.1	36.10	115	181	54.1	173	271	
Instantaneous Peak Torque	N·m	0.430	1.38	2.15	0.860	2.55* ⁵	2.26* ⁵	1.29	3.23* ⁵	4.31* ⁵	
	oz·in* ⁶	60.9	195	304	122	361* ⁵	320* ⁵	183	458* ⁵	610* ⁵	
Rated Current	A (rms)	2.1			2.0			2.9			
Instantaneous Maximum Current	A (rms)	6.0			5.7			8.6			
Rated Speed	min ⁻¹	600	187.5	120	600	187.5	120	600	188	120	
Instantaneous Maximum Speed* ³	min ⁻¹	1000	312.5	200	1000	312.5	200	1000	313	200	
Applicable Encoder	---	2048 P/R incremental encoder									
Moment of Inertia (converted to motor shaft) (motor + reduction gear) [$J_M = GD_M^2/4$]	Without Brake	$\times 10^{-4}$ kg·m ²	0.00529	0.00454	0.00418	0.00723	0.00648	0.00612	0.00917	0.00842	0.0806
		($\times 10^{-3}$ oz·in·s ²)* ⁶	0.0750	0.0643	0.0592	0.1024	0.0918	0.0867	0.1299	0.1193	1.142
	With Brake	$\times 10^{-4}$ kg·m ²	0.00662	0.00587	0.00551	0.00858	0.00783	0.00747	---		
		($\times 10^{-3}$ oz·in·s ²)* ⁶	0.0938	0.0832	0.0781	0.1216	0.1110	0.1058	---		
Brake (optional)* ⁴	Rated Voltage	V	24 VDC								
	Capacity	W	2.0			2.6			2.6		
	Holding Torque	---	Motor rated torque								

Note (1) The specifications and torque-motor speed characteristics are quoted in combination with a Servopack at an armature winding temperature of 100°C.

(2) Lost motion is 0.5° max. for all types.

(3) The output torque of the reduction gears is defined as follows:

Reduction gear output torque = Motor output torque x Deceleration rate x Efficiency
The efficiency of motor rated torque with a rated speed of 3000 min⁻¹ is 80%.

*¹ A planetary-pinion geared decelerator is used.

*² The rated torque is the continuous allowable torque at 40 °C with a heat sink attached. Heat sink dimensions: 150 x 150 x 3 mm (5.91 x 5.91 x 0.12 in.)

- *3 The maximum speed at the motor shaft is 5000 min⁻¹ max.
- *4 The brake is used as a holding brake (non-excitation operation). It cannot be used to stop the Servomotor.
- *5 The allowable torque is restricted by gears.
- *6 These values are reference values.

Electrical Specifications of the Holding Brake

SGMM Type (Rated Voltage: 24 VDC) Standard

Motor Type	Motor Capacity W (HP)	Holding Brake Specifications				
		Capacity W	Holding Torque N·m	Coil Resistance Ω (at 20°C)	Rated Current A (at 20°C)	Rated Current A (at 20°C)
SGMM-A1□□□□	10 (0.013)	2.0	0.0319	320	0.08	0.08
SGMM-A2□□□□	20 (0.027)	2.6	0.0637	221.5	0.11	0.11
SGMM-A3□□□□	30 (0.040)	2.6	0.0955	220	0.11	0.11



Holding Brake

The holding brake is automatically applied to the motor shaft to prevent the load falling in vertical axis applications when the motor power supply is turned off or fails. It is only to hold the load and cannot be used for stopping motor.

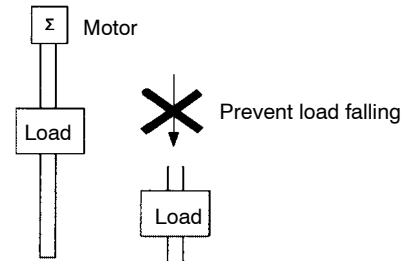

24-VDC Servomotor Torque-Motor Speed Characteristics

• SGMM-A1C, A1S

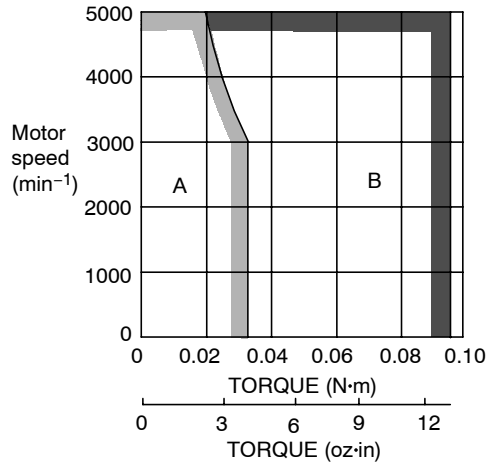

• SGMM-A2C, A2S

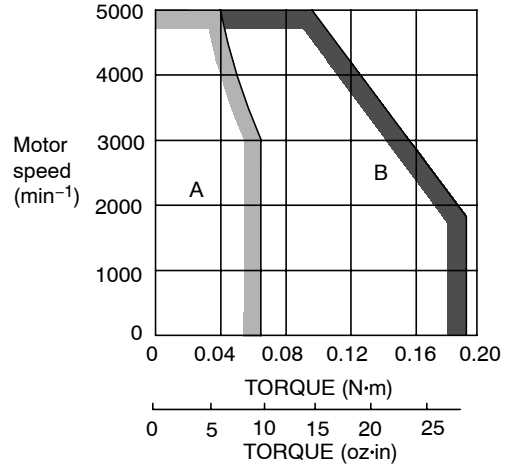

• SGMM-A3C

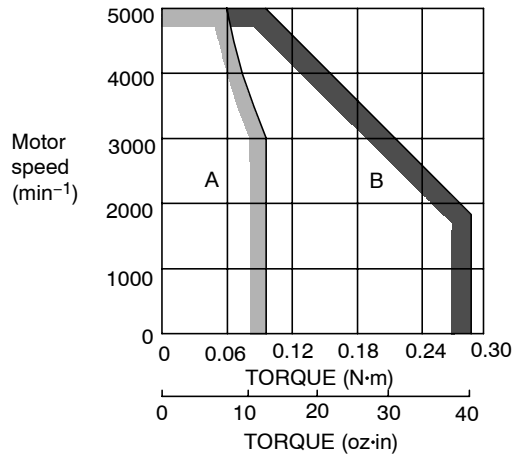

• SGMM-B3C

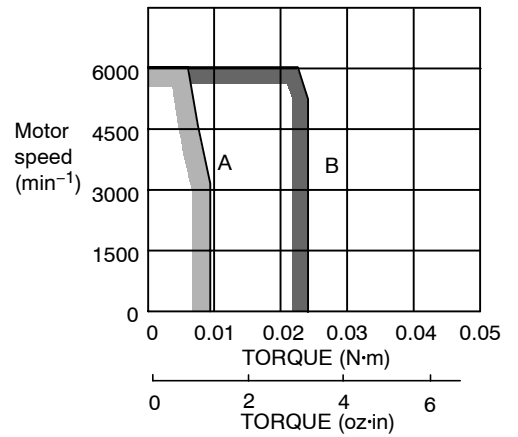

• SGMM-B5C

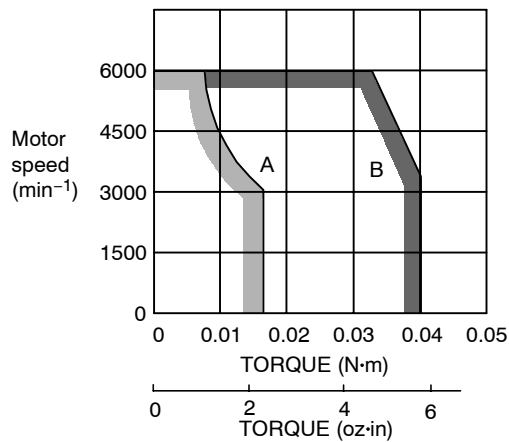

• SGMM-B9C

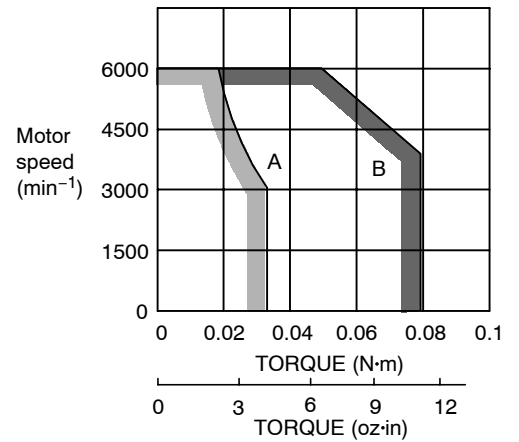

A: Continuous Duty Zone
B: Intermittent Duty Zone

4.2.2 Mechanical Characteristics

The mechanical characteristics of the Servomotor are described here.

Allowable Radial Load, Allowable Thrust Load

The output shaft allowable loads for Servomotors are shown below.

Conduct mechanical design so that the thrust loads and radial loads do not exceed the following values.

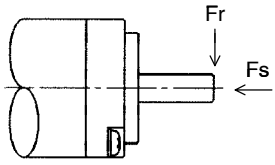
Servomotor Model SGMM-		Allowable Radial Load Fr [N(lb)]	Allowable Thrust Load Fs [N(lb)]	Reference Drawing
Standard	A1C31□□	34.1 (7.7)	14.7 (3.3)	
	A2C31□□	44.1 (9.9)		
	A3C31□□			
	B3CF1□	8 (1.8)	4.0 (0.9)	
	B5CF1□			
	B9CF1□	10 (2.2)		
With Gears	A1C3JA□□	51.9 (11.7)	47.0 (10.5)	
	A2C3JA□□			
	A1C3JB□□	76.4 (17.2)		
	A2C3JB□□			
	A1C3JC□□	89.2 (20.1)		
	A2C3JC□□			

Note a) The box (□) at the end of the model number is for the shaft specifications.

b) The allowable load is applied to the shaft end.

Mechanical Tolerance

The tolerances of the Servomotor output shaft and installation are shown in the following table.

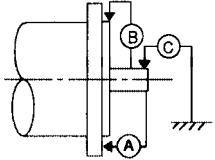
	Tolerance (T.I.R.)		Reference Diagram
	Standard	With Re- duction Gears	
Perpendicularity between flange face and output shaft (A)	0.04	0.06	
Mating concentricity of flange O.D. (B)	0.04	0.05	
Run-out at end of shaft (C)	0.02	0.04	

Note T.I.R. = Total Indicator Reading

Direction of Motor Rotation

Positive rotation of the Servomotor is counter-clockwise, viewing from the load.

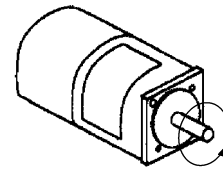

Impact Resistance

Mount the Servomotor with the shaft horizontal. The Servomotor must withstand the following vertical impacts.

- Impact Acceleration: 490 m/s^2
- Number of Impacts: 2

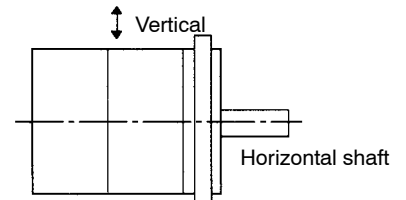

Note In Servomotors, an accurate detector is attached to the shaft at the opposite end from the load. Do not apply direct impact to the shaft as it may damage the detector.

Vibration Resistance

Mount the Servomotor with the shaft horizontal. The Servomotor must withstand the following vibration accelerations in three directions: vertical, transverse, and longitudinal. The amount of vibration the servomotor endures will vary depending on the application. Check the vibration acceleration being applied to your servomotor for each application.

- Vibration Acceleration: 49 m/s^2

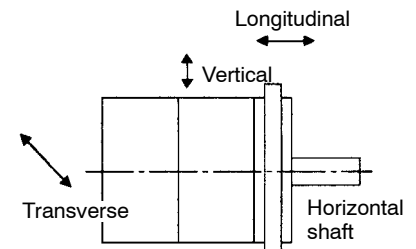

Vibration Class

The Servomotor meets the following **vibration class** at rated speed.

- Vibration Class: $15\mu\text{m}$ or below

Vibration Measurement Position

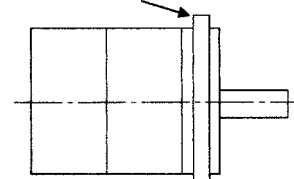

Enclosure Rating

The enclosure rating of the Servomotor conforms to IP55 standards.



Vibration Class

Vibration class $15\mu\text{m}$ or below indicates that the total amplitude of vibration of the motor alone, running at rated speed, does not exceed $15\mu\text{m}$.

4.3 Servopack Ratings and Characteristics

This section presents tables of Servopack ratings and specifications separately for speed/torque control and for position control.

4.3.1 Ratings and Specifications

The ratings and specifications of the Servopack are shown in the following table. Refer to them as required when selecting a Servopack.

Refer to the specifications listed for combination with the appropriate type of Servomotor.

Servopack for Speed/Torque Control

- SGDF-A□CS

SGDF Servopack			A1CS	A2CS	A3CS
Max. Applicable Motor Capacity W (HP)			10 (0.013)	20 (0.027)	30 (0.040)
Combined Specifications	Motor	Type SGMM-	A1C	A2C	A3C
		Motor Capacity W (HP)	10 (0.013)	20 (0.027)	30 (0.040)
		Rated/Max. Motor Speed	3000/5000 min ⁻¹		
		Applicable Encoder	2048 P/R incremental encoder		
		Allowable Load Moment of Inertia J _L × 10 ⁻⁴ kg·m ² (× 10 ⁻³ lb·in·s ²)	0.1064 (0.0942)	0.164 (0.1452)	0.2067 (0.1830)
	Continuous Output Current A (rms)	2.1	2.0	2.9	
	Max. Output Current A (rms)	6.0	5.7	8.6	
Basic Specifications	Power Supply		24 VDC ± 10%, continuous: 1.2A, peak: 9A	24 VDC ± 10%, continuous: 1.7A, peak: 9A	24 VDC ± 10%, continuous: 2.3A, peak: 12A
	Control Method		MOSFET-PWM		
	Feedback		2048 P/R incremental encoder		
	Location	Ambient Temp.	0°C to 50°C*1		
		Storage Temp.	-20°C to +85°C		
		Ambient/Storage Humidity	90% or less (with no condensation)		
		Vibration/Shock Resistance	Frequency: 10 to 55 Hz Amplitude: 0.075 mm Acceleration: 9.8 m/s ² /147m/s ²		
	Structure		Base mounted		
	Approx. Mass (kg)		0.3		

SGDF Servopack		A1CS	A2CS	A3CS
Performance	Speed Control Range*2		1:5000	
	Speed Regulation*3	Load Regulation	0% to 100%:0.01% max. (at rated speed)	
		Voltage Regulation	0%	
		Temperature Regulation	25°C ± 25°C: ± 0.1% max. (at rated speed)	
	Frequency Characteristics		250 Hz (at $J_L=J_M$)	
	Torque Control (Repeatability)		± 2.0%	
Accel/Decel Time Setting		0 to 10 s		
Input Signal	Speed Reference	Rated Reference Voltage	± 6 VDC (forward motor rotation with positive reference) at rated speed Variable setting range: ± 2 to ± 10 VDC at rated speed	
		Input Impedance	Approx. 30 kΩ	
		Circuit Time Constant	Approx. 47 μs	
	Torque Reference	Rated Reference Voltage	± 3 VDC (forward motor rotation with positive reference) at rated torque Variable setting range: ± 1 to ± 10 VDC at rated torque	
		Input Impedance	Approx. 30 kΩ	
		Circuit Time Constant	Approx. 47 μs	
I/O Signals	Position Output	Output Form	Phase-A, -B, -C line driver	
		Frequency Dividing Ratio	(16 to N) / N N=2048*4	
	Sequence Input (2 Inputs)		Servo ON, P drive (or motor forward/reverse by zero-clamp drive reference, or contact input speed control), alarm reset, current limit (select from parameters)	
	Sequence Output (2 Outputs)		Current limit detection, TGON, speed coincidence, external brake interlock, servo alarm (servo alarms are fixed, other settings are selected from parameters)	
Protective Functions			Overcurrent, overload, overspeed, reference input read error, overrun prevention, CPU error, encoder error	
Indicators			LED indicators Red: Alarm, Green: Ready	
Others			Torque control, zero-clamp operation (position loop stop), soft start/stop, speed coincidence, brake interlock signal output, JOG run, autotuning	

*1 Use within the ambient temperature range. When enclosed in a box, the internal temperatures must not exceed the ambient temperature range.

*2 The lowest speed of the speed control range is the speed at which the motor does not stop under 100% load.

SERVO SELECTION AND DATA SHEETS

4.3.1 Ratings and Specifications

*3 Speed regulation is defined as follows:

$$\text{Speed regulation} = \frac{\text{No-load-speed} - \text{Full-load-speed}}{\text{Rated speed}} \times 100\%$$

The motor speed may change due to voltage variations or amplifier drift and changes in processing resistance due to temperature variation.

These ratios of the speed changes to the rated speed represent the speed regulation due to voltage and temperature variations.

*4 N is the number of encoder pulses.

• SGDF-B□CS

SGDF Servopack		B3CS	B5CS	B9CS	
Max. Applicable Motor Capacity W (HP)		3 (0.004)	5 (0.007)	10 (0.013)	
Combined Specifications	Motor	Type SGMM-	B3CF1	B5CF1	B9CF1
		Motor Capacity W (HP)	3 (0.004)	5 (0.007)	10 (0.013)
	Rated/Max. Motor Speed	3000/6000 min ⁻¹			
	Applicable encoder	1024 P/R incremental encoder			
	Allowable Load Moment of Inertia J _L × 10 ⁻⁴ kg·m ² (× 10 ⁻³ lb·in·s ²)	0.012 (0.011)	0.024 (0.021)	0.066 (0.058)	
	Continuous Output Current A (rms)	1.3	1.3	1.5	
	Max. Output Current A (rms)	3.5	3.6	3.9	
Basic Specifications	Power Supply		24 VDC ± 10%, continuous: 0.9A, peak: 5.0A	24 VDC ± 10%, continuous: 1.0A, peak: 5.1A	24 VDC ± 10%, continuous: 1.2A, peak: 5.5A
	Control Method		MOSFET-PWM		
	Feedback		1024 P/R incremental encoder		
	Location	Ambient Temp.	0°C to 50°C*1		
		Storage Temp.	-20°C to +85°C		
		Ambient/Storage Humidity	90% or less (with no condensation)		
		Vibration/Shock Resistance	4.9 m/s ² /19.6m/s ²		
	Structure		Base mounted		
	Approx. Mass (kg)		0.3		
	Performance	Speed Control Range*2		1:5000	
Speed Regulation*3		Load Regulation	0% to 100%:0.01% max. (at rated speed)		
		Voltage Regulation	0%		
		Temperature Regulation	25°C ± 25°C: ± 0.1% max. (at rated speed)		
Frequency Characteristics		250 Hz (at J _L =J _M)			
Torque Control (Repeatability)		± 2.0%			
Accel/Decel Time Setting		0 to 10 s			

SGDF Servopack			B3CS	B5CS	B9CS
Input Signal	Speed Reference	Rated Reference Voltage	± 6 VDC (forward motor rotation with positive reference) at rated speed Variable setting range: ± 2 to ± 10 VDC at rated speed		
		Input Impedance	Approx. 30 kΩ		
		Circuit Time Constant	Approx. 47 μs		
	Torque Reference	Rated Reference Voltage	± 3 VDC (forward motor rotation with positive reference) at rated torque Variable setting range: ± 1 to ± 10 VDC at rated torque		
		Input Impedance	Approx. 30 kΩ		
		Circuit Time Constant	Approx. 47 μs		
I/O Signals	Position Output	Output Form	Phase-A, -B, -C line driver		
		Frequency Dividing Ratio	(16 to N) / N N=1024*4		
	Sequence Input (2 Inputs)		Servo ON, P drive (or motor forward/reverse by zero-clamp drive reference, or contact input speed control), alarm reset, current limit (select from parameters)		
	Sequence Output (2 Outputs)		Current limit detection, TGON, speed coincidence, external brake interlock, servo alarm (servo alarms are fixed, other settings are selected from parameters)		
Protective Functions			Overcurrent, overload, overspeed, reference input read error, overrun prevention, CPU error, encoder error		
Indicators			LED indicators Red: Alarm, Green: Ready		
Others			Torque control, zero-clamp operation (position loop stop), soft start/stop, speed coincidence, brake interlock signal output, JOG run, autotuning		

*1 Use within the ambient temperature range. When enclosed in a box, the internal temperatures must not exceed the ambient temperature range.

*2 The lowest speed of the speed control range is the speed at which the motor does not stop under 100% load.

*3 Speed regulation is defined as follows:

$$\text{Speed regulation} = \frac{\text{No-load-speed} - \text{Full-load-speed}}{\text{Rated speed}} \times 100\%$$

The motor speed may change due to voltage variations or amplifier drift and changes in processing resistance due to temperature variation.

These ratios of the speed changes to the rated speed represent the speed regulation due to voltage and temperature variations.

*4 N is the number of encoder pulses.

Servopack for Position Control

- SGDF-A□CP

SGDF Servopack			A1CP	A2CP	A3CP
Max. Applicable Motor Capacity W (HP)			10 (0.013)	20 (0.027)	30 (0.040)
Combined Specifications	Motor	Type SGMM-	A1C	A2C	A3C
		Motor Capacity W (HP)	10 (0.013)	20 (0.027)	30 (0.040)
		Rated/Max. Motor Speed	3000/5000 min ⁻¹		
		Applicable encoder	2048 P/R incremental encoder		
		Allowable Load Moment of Inertia J _L × 10 ⁻⁴ kg·m ² (× 10 ⁻³ lb.in.s ²)	0.1064 (0.0942)	0.164 (0.1452)	0.2067 (0.1830)
	Continuous Output Current A (rms)	2.1	2.0	2.9	
	Max. Output Current A (rms)	6.0	5.7	8.6	
Basic Specifications	Power Supply		24 VDC ± 10%, continuous: 2.4A, peak: 9A	24 VDC ± 10%, continuous: 2.9A, peak: 9A	24 VDC ± 10%, continuous: 2.3A, peak: 12A
	Control Method		MOSFET-PWM		
	Feedback		2048 P/R incremental encoder		
	Location	Ambient Temp.	0°C to 50°C*1		
		Storage Temp.	-20°C to +85°C		
		Ambient/Storage Humidity	90% or less (with no condensation)		
		Vibration/Shock Resistance	Frequency: 10 to 55 Hz Amplitude: 0.075 mm Acceleration: 9.8 m/s ² /147m/s ²		
	Structure		Base mounted		
	Approx. Mass (kg)		0.3		
Performance	Bias Setting		0 to 450 min ⁻¹ . (Setting resolution: 1 min ⁻¹ .)		
	Feed Forward Compensation		0% to 100% (Setting resolution: 1%)		
	Position Complete Width Setting		0 to 250 reference units. Reference unit: minimum unit of position data which moves load		
Input Signal	Reference Pulse	Type	SIGN + PULSE train, 90° phase difference 2-phase pulse, (Phase-A + Phase-B), CCW pulse+CW pulse		
		Pulse Form	Line driver (+5 V level), open collector (+5 V or +12 V level)		
		Pulse Frequency	0 to 450 kpps		
	Control Signal		CLEAR (input pulse form identical to reference pulse)		

4

SGDF Servopack			A1CP	A2CP	A3CP
I/O Signals	Position Output	Output Form	Phase-A, -B, -C open-collector output		
		Frequency Dividing Ratio	(16 to N) /N N=2048*2		
	Sequence Input (2 Inputs)		Servo ON, P drive, alarm reset, current control (select from parameters)		
	Sequence Output (2 Outputs)		Current limit detection, TGON, positioning complete, brake interlock, servo alarm (servo alarms are fixed and other settings are selected from parameters)		
Protective Functions			Overcurrent, overload, overspeed, overrun prevention, CPU error, encoder error, overflow		
Indicators			LED indicators Red: Alarm, Green: Ready		
Others			Brake interlock signal output, JOG run, autotuning, electronic gear		

*1 Use within the ambient temperature range. When enclosed in a box, the internal temperatures must not exceed the ambient temperature range.

*2 N is the number of encoder pulses.

- SGDF-B□CP

SGDF Servopack			B3CP	B5CP	B9CP	
Max. Applicable Motor Capacity			W (HP)	3 (0.004)	5 (0.007)	10 (0.013)
Combined Specifications	Motor	Type SGMM-	B3CF1	B5CF1	B9CF1	
		Motor Capacity W (HP)	3 (0.004)	5 (0.007)	10 (0.013)	
		Rated/Max. Motor Speed	3000/6000 min ⁻¹			
		Applicable encoder	1024 P/R incremental encoder			
		Allowable Load Moment of Inertia J _L × 10 ⁻⁴ kg·m ² (× 10 ⁻³ lb·in·s ²)	0.012 (0.011)	0.024 (0.021)	0.066 (0.058)	
	Continuous Output Current A (rms)	1.3	1.3	1.5		
	Max. Output Current A (rms)	3.5	3.6	3.9		
Basic Specifications	Power Supply		24 VDC ± 10%, continuous: 0.9A, peak: 5.0A	24 VDC ± 10%, continuous: 1.0A, peak: 5.1A	24 VDC ± 10%, continuous: 1.2A, peak: 5.5A	
	Control Method		MOSFET-PWM			
	Feedback		1024 P/R incremental encoder			
	Location	Ambient Temp.	0°C to 50°C*1			
		Storage Temp.	-20°C to +85°C			
		Ambient/Storage Humidity	90% or less (with no condensation)			
		Vibration/Shock Resistance	4.9 m/s ² /19.6m/s ²			
	Structure		Base mounted			
	Approx. Mass (kg)		0.3			

SERVO SELECTION AND DATA SHEETS

4.3.1 Ratings and Specifications

SGDF Servopack		B3CP	B5CP	B9CP
Performance	Bias Setting		0 to 450 min ⁻¹ . (Setting resolution: 1 min ⁻¹ .)	
	Feed Forward Compensation		0% to 100% (Setting resolution: 1%)	
	Position Complete Width Setting		0 to 250 reference units. Reference unit: minimum unit of position data which moves load	
Input Signal	Reference Pulse	Type	SIGN + PULSE train, 90° phase difference 2-phase pulse, (Phase-A + Phase-B), CCW pulse+CW pulse	
		Pulse Form	Line driver (+5 V level), open collector (+5 V or +12 V level)	
		Pulse Frequency	0 to 450 kpps	
	Control Signal		CLEAR (input pulse form identical to reference pulse)	
I/O Signals	Position Output	Output Form	Phase-A, -B, -C line driver output	
		Frequency Dividing Ratio	(16 to N) /N N=1024* ²	
	Sequence Input (2 Inputs)		Servo ON, P drive, alarm reset, current control (select from parameters)	
	Sequence Output (2 Outputs)		Current limit detection, TGON, positioning complete, brake interlock, servo alarm (servo alarms are fixed and other settings are selected from parameters)	
Protective Functions			Overcurrent, overload, overspeed, overrun prevention, CPU error, encoder error, overflow	
Indicators			LED indicators Red: Alarm, Green: Ready	
Others			Brake interlock signal output, JOG run, autotuning, electronic gear	

*1 Use within the ambient temperature range. When enclosed in a box, the internal temperatures must not exceed the ambient temperature range.

*2 N is the number of encoder pulses.

4.3.2 Overload Characteristics

The Servopack has a built-in overload protective function to protect the Servopack and Servomotor from overload. Therefore, the Servopack allowable power is limited by the overload protective function, as shown in the following graph.

The overload detection level is quoted under **hot start** conditions at a motor ambient temperature of 40°C.

4

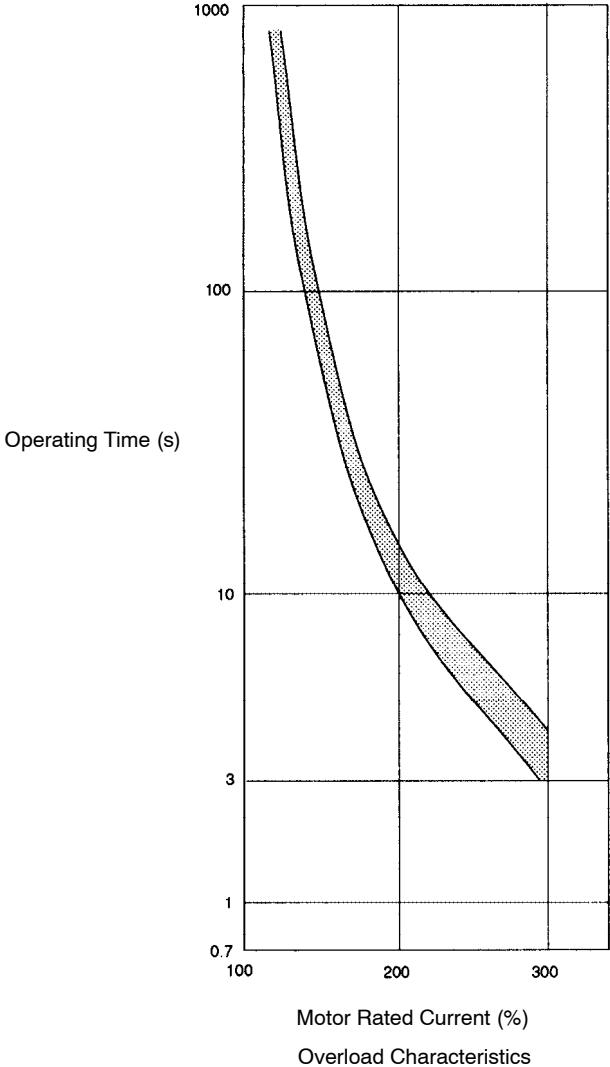

Hot Start

Indicates that both Servopack and Servomotor have run long enough at rated load to be thermally saturated.

4.3.3 Starting Time and Stopping Time

1) The motor starting time (t_r) and stopping time (t_f) under constant load are calculated by the following formulas. The motor viscous torque and friction torque are ignored.

$$\text{Starting Time: } t_r = 104.7 \times \frac{N_R (J_M + J_L)}{K_t \cdot I_R (\alpha - \beta)} \text{ [ms]}$$

$$\text{Stopping Time: } t_f = 104.7 \times \frac{N_R (J_M + J_L)}{K_t \cdot I_R (\alpha + \beta)} \text{ [ms]}$$

N_R : Motor speed used (min^{-1} .)

J_M : Motor moment of inertia ($\text{kg}\cdot\text{m}^2 = \text{lb}\cdot\text{in}\cdot\text{s}^2$) ... ($\text{GD}^2_M/4$)

J_L : Load converted to shaft moment of inertia ($\text{kg}\cdot\text{m}^2$) .. ($\text{GD}^2_L/4$)

K_t : Motor torque constant ($\text{N}\cdot\text{m}/\text{A} = \text{lb}\cdot\text{in}/\text{A}$)

I_R : Motor rated current (A)

$\alpha = I_P/I_R$: Accel/decel current coefficient

[where I_P is accel/decel current (accel/decel current is α times the motor rated current) (A)]

$\beta = I_L/I_R$: Load current coefficient

[I_L : Load torque equivalent current (load current is β times the motor rated current) (A)]

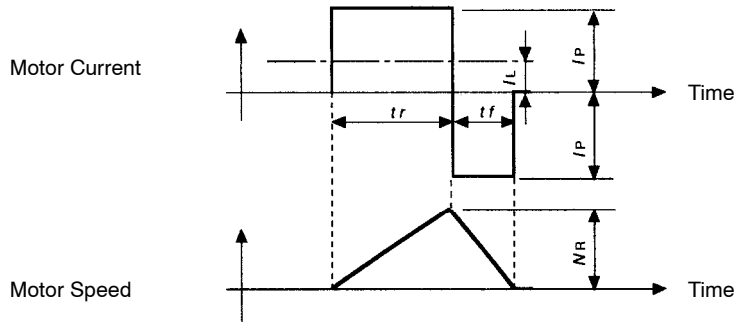

Motor Current (size) - Motor Speed Timing Chart

4.3.4 Overhanging Loads

A Servomotor may not be operated under an overhanging load, that is a load which tends to continually rotate the motor.

Under an overhanging load (e.g. when the direction of the torque applied by the motor is opposite from the direction of shaft rotation), the Servopack regenerative brake is applied continuously and the regenerative energy of the load may exceed the allowable range and damage the Servopack.

The regenerative brake capacity of the Servopack is rated for short-time operation, approximately equivalent to the deceleration stopping time.

- Overhanging Load Example 1: Motor drive for vertical axis, using no counterweight

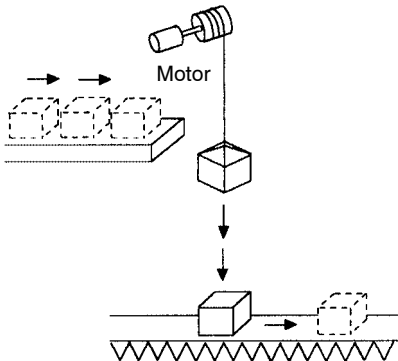

- Overhanging Load Example 2: Tension control drive

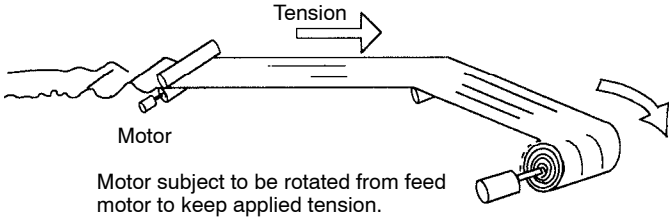

4

4.3.5 In-rush Current and Power Loss

The following table shows the inrush current and power loss for each Servopack.

Servopack Type	Capacity (W)	Inrush Current (A _{op})	Output Current (A rms)	Power Loss (W)
SGDF-A1C	10	3.8	2.1	7
SGDF-A2C	20	3.8	2.0	7
SGDF-A3C	30	3.8	2.9	7
SGDF-B3C	3	3.8	1.3	7
SGDF-B5C	5	3.8	1.3	7
SGDF-B9C	10	3.8	1.5	7

4.4 Servo Drive Dimensional Drawings

This section provides dimensional drawings of the Servomotor, Servopack, and Digital Operator.

4.4.1 Servomotor Dimensional Drawings

The dimensional drawings of the Servomotors are broadly grouped into the following four categories depending on the type of encoder and whether a brake is used.

- Incremental Encoders without Brakes
- Incremental Encoders with Brakes
- Incremental Encoders without Brakes but with Reduction Gears
- Incremental Encoders with Brakes and Reduction Gears

Incremental Encoders without Brakes (Type SGMM-A□C31□)

• 10 W, 20 W, 30 W

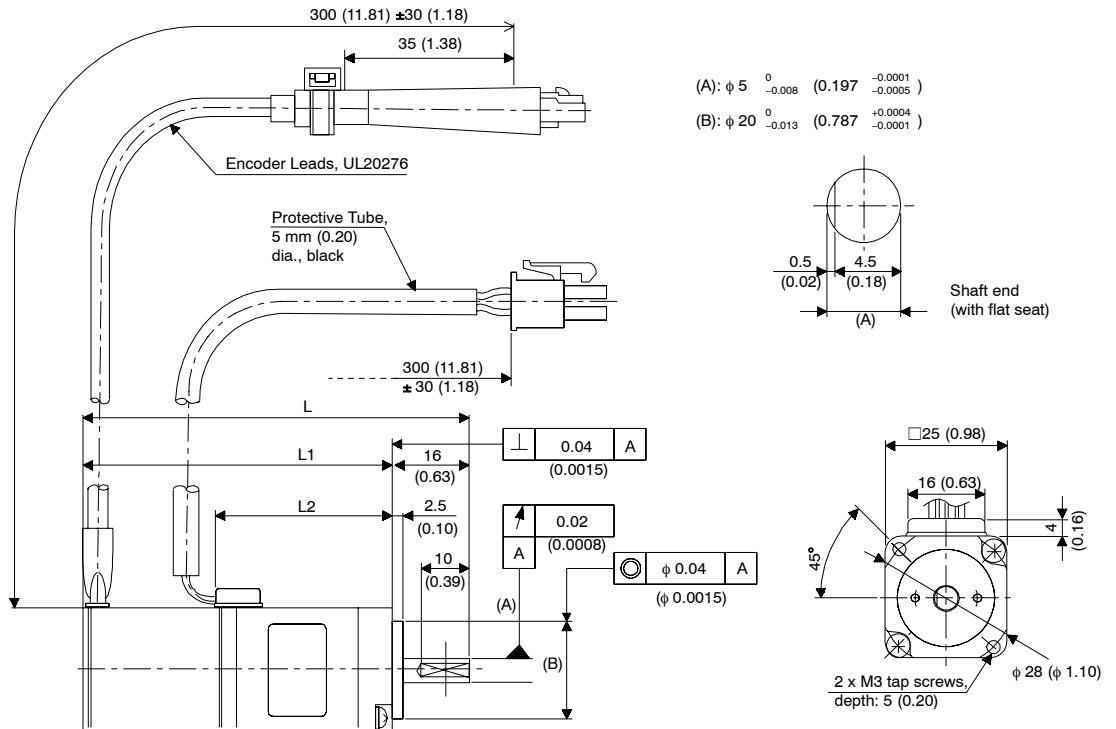

Type SGMM-	Shaft End Specifications	L mm (in)	L1 mm (in)	L2 mm (in)	Output W (HP)	Torque N•m (lb•m)	Time Rating	Rated Speed (min ⁻¹)	Allowable Radial Load N (lb)	Allowable Thrust Load N (lb)
A1C312	No flat seat	70 (2.76)	54 (2.13)	26.5 (1.04)	10 (0.013)	0.032 (0.007)	Continuous	3000	34.3 (7.7)	14.7 (3.3)
A1C313	With flat seat									
A2C312	No flat seat	80 (3.15)	64 (2.52)	36.5 (1.44)	20 (0.027)	0.064 (0.014)			44.1 (9.9)	
A2C313	With flat seat									
A3C312	No flat seat	90 (3.54)	74 (2.91)	46.5 (1.83)	30 (0.040)	0.096 (0.022)				
A3C313	With flat seat									

Note 1) The detector uses a 2048 P/R incremental encoder 2048 P/R.

2) The allowable load is applied to the shaft end.

SERVO SELECTION AND DATA SHEETS

4.4.1 Servomotor Dimensional Drawings

• 3 W, 5 W, 10 W

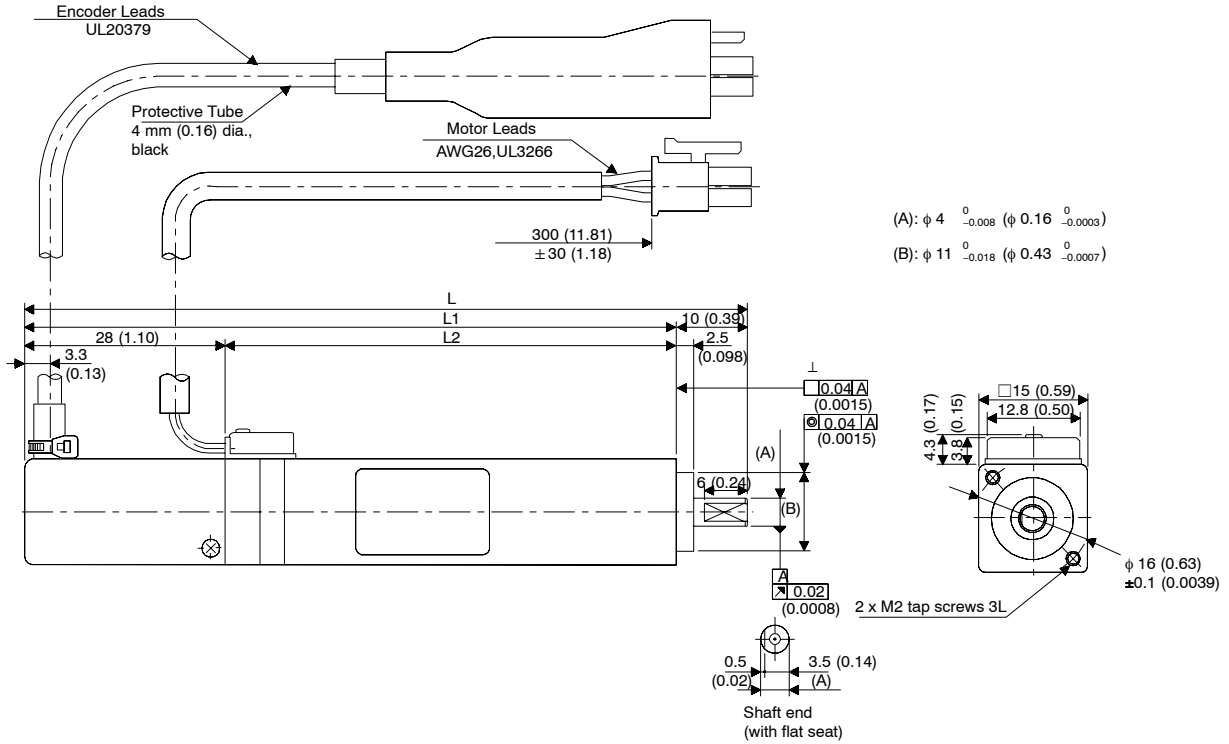

4

Type SGMM-	Shaft End Specifications	L mm (in)	L1 mm (in)	L2 mm (in)	Output W (HP)	Torque N•m (lb•m)	Time Rating	Rated Speed (min ⁻¹)	Approx. Mass (g)	Allowable Radial Load N (lb)	Allowable Thrust Load N (lb)
B3CF12	No flat seat	62 (2.44)	52 (2.05)	24 (0.94)	3 (0.004)	0.00955 (0.002)	Continuous	3000	55	8 (1.8)	4 (0.9)
B3CF13	With flat seat										
B5CF12	No flat seat	68 (2.68)	58 (2.28)	30 (1.18)	5 (0.007)	0.0159 (0.004)			60		
B5CF13	With flat seat										
B9CF12	No flat seat	102 (4.02)	92 (3.62)	64 (2.52)	10 (0.013)	0.0318 (0.007)			100	10 (2.2)	
B9CF13	With flat seat										

Note 1) The detector uses a 1024 P/R incremental encoder.

2) The allowable load is applied to the shaft end.

Incremental Encoders with Brakes (Type SGMM-A□C31□C)

- 10 W, 20 W, 30 W

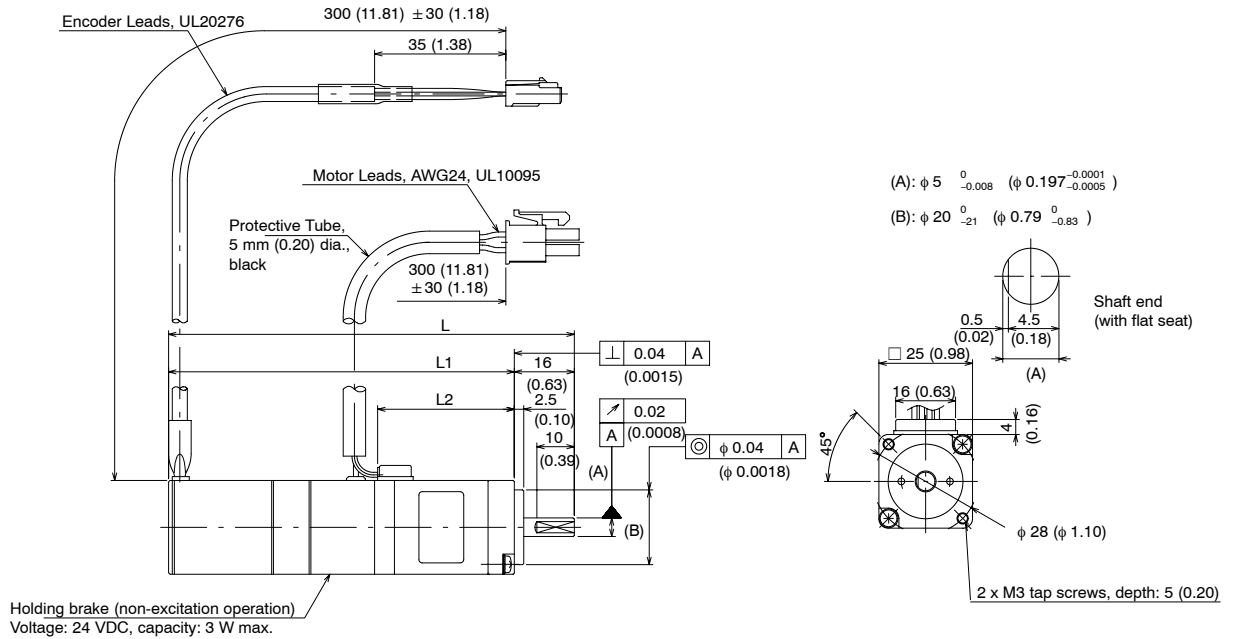

Type SGMM-	Shaft End Specifications	L mm (in)	L1 mm (in)	L2 mm (in)	Output W (HP)	Torque N·m (lb·m)	Time Rating	Rated Speed (min ⁻¹)	Allowable Radial Load N (lb)	Allowable Thrust Load N (lb)
A1C312C	No flat seat	94.5 (3.72)	78.5 (3.09)	26.5 (1.04)	10 (0.013)	0.032 (0.007)	Continuous	3000	34.3 (7.7)	14.7 (3.3)
A1C313C	With flat seat									
A2C312C	No flat seat	108.5 (4.27)	92.5 (3.64)	36.5 (1.44)	20 (0.027)	0.064 (0.014)			44.1 (9.9)	
A2C313C	With flat seat									
A3C312C	No flat seat	128.5 (5.06)	112.5 (4.43)	46.5 (1.83)	30 (0.040)	0.096 (0.022)				
A3C313C	With flat seat									

Note 1) The detector uses a 2048 P/R incremental encoder.

2) The allowable load is applied to the shaft end.

Incremental Encoders with Reduction Gears (Model SGMM-A□C3J□2)

• 10 W, 20 W

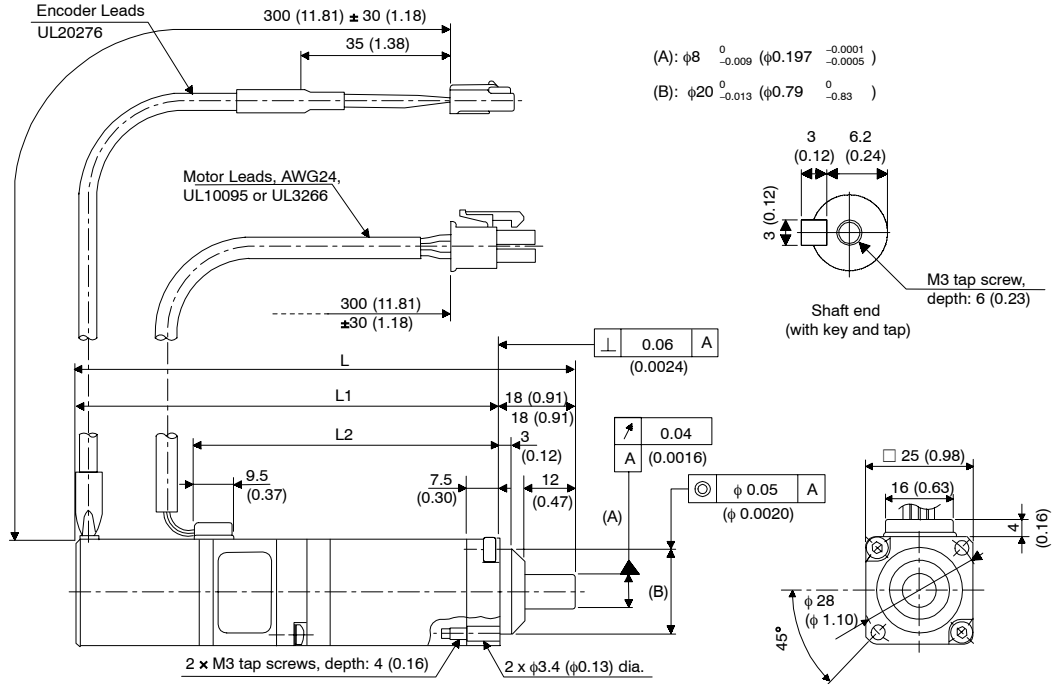

4

Type SGMM-	L mm (in)	L1 mm (in)	L2 mm (in)	Approx. Mass (g)	Motors			
					Output W (HP)	Torque N•m (lb•m)	Time Rating	Rated Speed (min ⁻¹)
A1C3JA2	106.5 (4.19)	88.5 (3.48)	61 (2.4)	230	10 (0.013)	0.032 (0.007)	Continuous	3000
A1C3JB2	117 (4.61)	99 (3.9)	71.5 (2.81)	225				
A1C3JC2								
A2C3JA2	116.5 (4.59)	98.5 (3.88)	71 (2.8)	270	20 (0.027)	0.064 (0.014)		
A2C3JA2	127 (5)	109 (4.29)	81.5 (3.21)	305				
A2C3JC2								

Type SGMM-	Reduction Gears					
	Gear Ratio	Torque N•m (lb•m)	Rated Speed (min ⁻¹)	Allowable Radial Load N (lb)	Allowable Thrust Load N (lb)	Lost Motion
A1C3JA2	1/5	0.127 (0.029)	600	51.9 (11.67)	47.0 (10.57)	0.5 (deg)
A1C3JB2	1/16	0.407 (0.092)	187.5	76.4 (17.19)		
A1C3JC2	1/25	0.636 (0.143)	120	89.2 (20.07)		
A2C3JA2	1/5	0.255 (0.057) *	600	51.9 (11.67)		
A2C3JB2	1/16	0.815 (0.183)	187.5	76.4 (17.19)		
A2C3JC2	1/25	1.274 (0.287)	120	89.2 (20.07)		

- Note**
- 1) The detector uses a 2048 P/R incremental encoder.
 - 2) The instantaneous max. torque of the reduction gear with * is allowable max. torque of the reduction gear. The value is not that as three times as the rated torque.

Incremental Encoders (Model SGMM-A□C3J□6)

• 10 W, 20 W

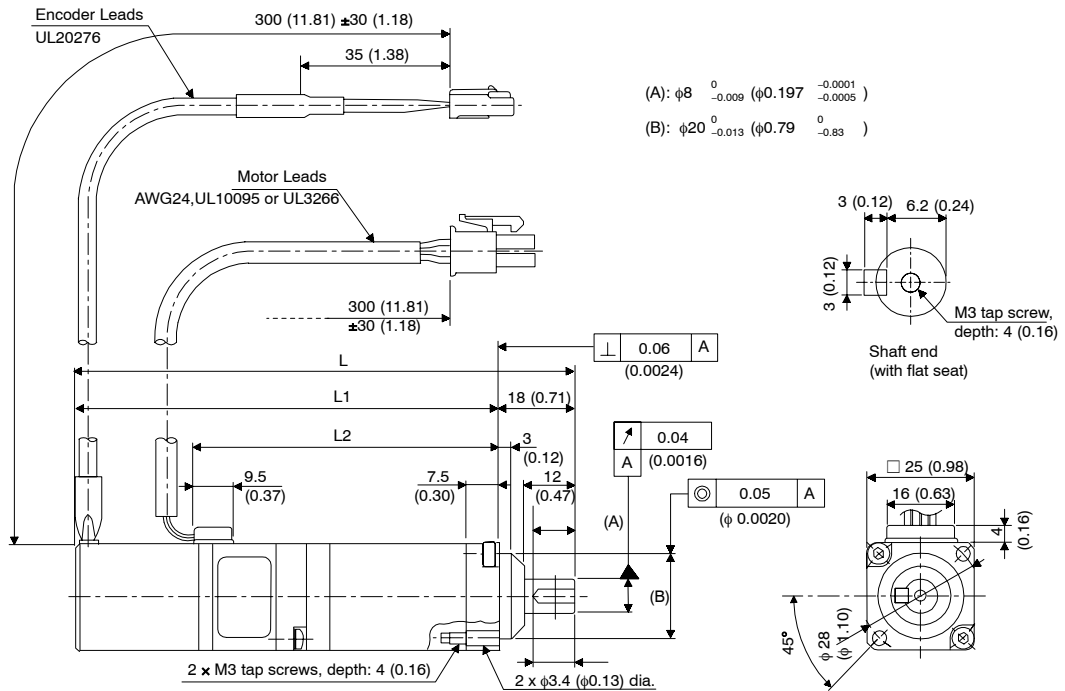

Type SGMM-	L mm (in)	L1 mm (in)	L2 mm (in)	Approx. Mass (g)	Motors			
					Output W (HP)	Torque N·m (lb·m)	Time Rating	Rated Speed (min ⁻¹)
A1C3JA6	106.5 (4.19)	88.5 (3.48)	61 (2.4)	315	10 (0.013)	0.032 (0.007)	Continuous	3000
A1C3JB6 A1C3JC6	117 (4.61)	99 (3.9)	71.5 (2.81)	350				
A2C3JA6	116.5 (4.59)	98.5 (3.88)	71 (2.8)	370	20 (0.027)	0.064 (0.014)		
A2C3JB6	127 (5)	109 (4.29)	81.5 (3.21)	405				
A2C3JC6								

Type SGMM-	Reduction Gears					
	Gear Ratio	Torque N·m (lb·m)	Rated Speed (min ⁻¹)	Allowable Radial Load N (lb)	Allowable Thrust Load N (lb)	Lost Motion
A1C3JA6	1/5	0.127 (0.029)	600	51.9 (11.67)	47.0 (10.57)	0.5 (deg)
A1C3JB6	1/16	0.407 (0.092)	187.5	76.4 (17.19)		
A1C3JC6	1/25	0.636 (0.143)	120	89.2 (20.07)		
A2C3JA6	1/5	0.255 (0.057) *	600	51.9 (11.67)		
A2C3JB6	1/16	0.815 (0.183)	187.5	76.4 (17.19)		
A2C3JC6	1/25	1.274 (0.287)	120	89.2 (20.07)		

- Note**
- 1) The detector uses a 2048 P/R incremental encoder.
 - 2) The instantaneous max. torque of the reduction gear with * is allowable max. torque of the reduction gear. The value is not that as three times as the rated torque.
 - 3) The keyway complies with JIS B 1301-1976 (precision). A straight key is supplied (type with key only).

Incremental Encoders with Reduction Gears (Model SGMM-A3C3J□□)

• 30 W

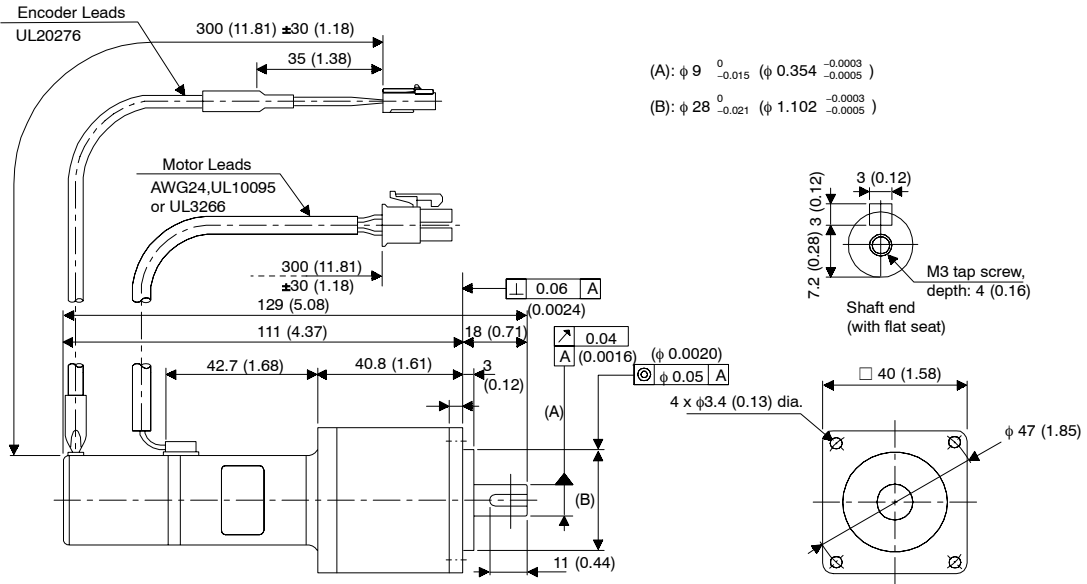

4

Type SGMM-	Reduction Gear + Motor Moment of Inertia (Converted to Motor Shaft) $\text{kg}^2 \cdot \text{m}^2$ (GD/4)	Shaft End Specifications With/Without Tap	Approx. Mass (g)	Motors			
				Output W (HP)	Torque N·m (lb·m)	Time Rating	Rated Speed (min^{-1})
A3C3J12	$\times 10^{-6}$ 0.917	Without	445	30 (0.040)	0.096 (0.022)	Continuous	3000
A3C3J16		With					
A3C3J22	$\times 10^{-6}$ 0.842	Without					
A3C3J26		With					
A3C3J32	$\times 10^{-6}$ 0.806	Without					
A3C3J36		With					

Type SGMM-	Reduction Gears					
	Gear Ratio	Torque N·m (lb·m)	Rated Speed (min^{-1})	Allowable Radial Load N (lb)	Allowable Thrust Load N (lb)	Lost Motion
A3C3J12	1/5	0.382 (0.086)	600	69 (15.5)	59 (13.3)	0.5 (deg)
A3C3J16						
A3C3J22	1/16	1.22 (0.274)	187.5	147 (33.1)		
A3C3J26						
A3C3J32	1/25	1.91 (0.430)	120	186 (41.8)		
A3C3J36						

- Note**
- 1) The detector uses a 2048 P/R incremental encoder.
 - 2) The keyway complies with JIS B 1301-1976 (precision). A straight key is supplied (types with key only).
 - 3) The allowable load is applied to the shaft end.

**Incremental Encoders with Brakes and Reduction Gears
(Model SGMM-A□C3J□□C)**

- 10 W, 20 W

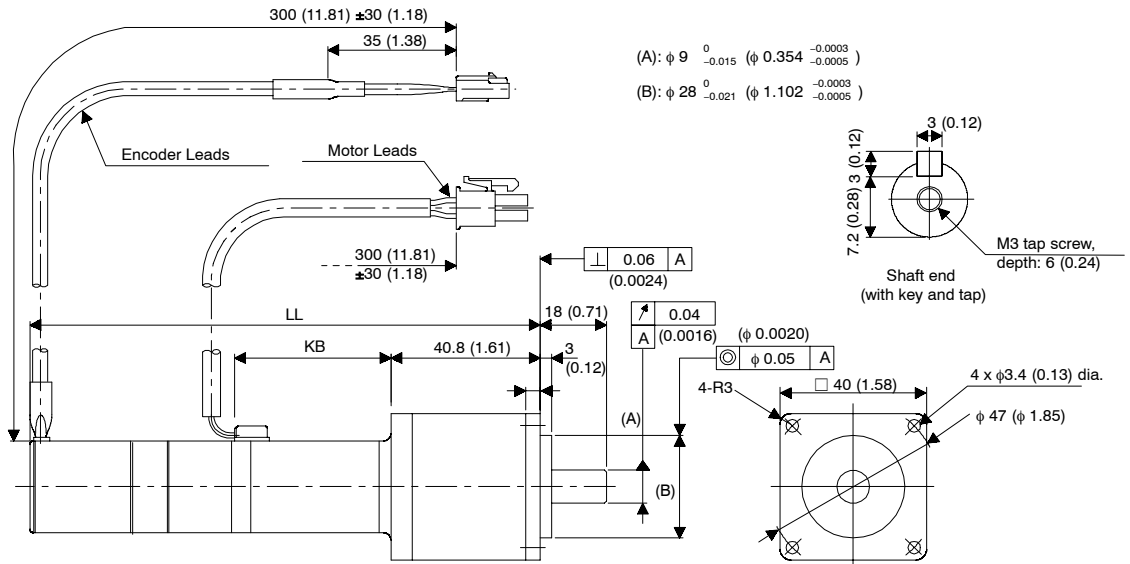

Type SGMM-	L1 mm (in)	KB mm (in)	Approx. Mass (g)
A1C3JA□C	113 (4.45)	61 (2.4)	315
A1C3JB□C	127.5 (5.02)	71.5 (2.81)	350
A1C3JC□C			
A2C3JA□C	123 (4.84)	71 (2.8)	370
A2C3JA□C	137.5 (5.41)	81.5 (3.21)	405
A2C3JA□C			

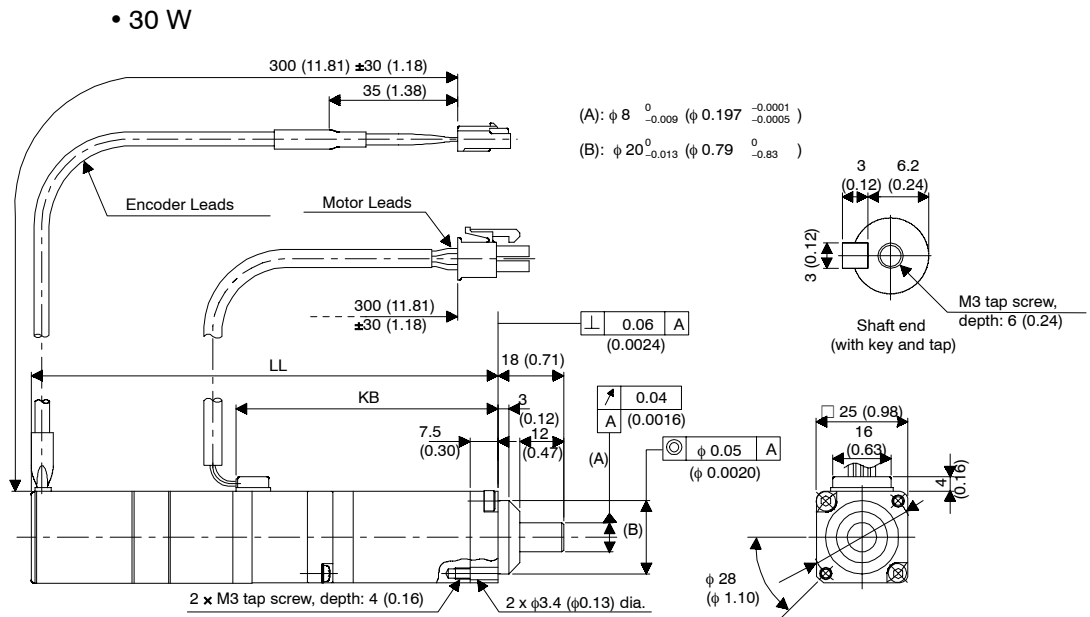

Type SGMM-	L1 mm (in)	KB mm (in)	Approx. Mass (g)
A1C3J□C	149.5 (5.89)	52.7 (2.07)	545

Encoder Plugs

• Incremental Encoder Connection Specifications

• SGMM-A□C

1	A channel output	Blue
2	/A channel output	Blue/Black
3	B channel output	Yellow
4	/B channel output	Yellow/Black
5	C channel output	Green
6	/C channel output	Green/Black
7	0 V (power supply)	Gray
8	+5 V (power supply)	Red
9	FG (frame ground)	Orange

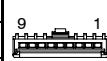

Receptacle: 51111-0910
(Molex Japan)

Terminal: 50397-8□00

At other end:

Plug: 51112-09□0

Terminal: 50398-8□00

• SGMM-B□C

1	A channel output	Blue
2	B channel output	Yellow
3	C channel output	Green
4	0 V (power supply)	Gray
5	FG (frame ground)	Orange
6	/A channel output	Blue/Black
7	/B channel output	Yellow/Black
8	/C channel output	Green/Black
9	+5 V (power supply)	Red



Plug: 43020-1001

Socket: 43031-0004
(Molex Japan)

Motor Plugs

• SGMM-A□ Motor Connection Specifications

• Without Brake

1	Phase U	Red
2	Phase V	White
3	Phase W	Blue
4	FG (frame ground)	Green



Receptacle: 5557-04R
(Molex Japan)

Terminal: 5556T

At other end:

Plug: 5559-04P

Terminal: 5558T

• With Brake

1	Phase U	Red
2	Phase V	White
3	Phase W	Blue
4	FG (frame ground)	Green
5	Brake	Black
6	Brake	Black



Receptacle: 5557-06R
(Molex Japan)

Terminal: 5556T

At other end:

Plug: 5559-06P

Terminal: 5558T

• SGMM-B□ Motor Connection Specifications

1	Phase U	Red
2	Phase V	White
3	Phase W	Blue
4	FG (frame ground)	Green



Receptacle: 5557-04R
(Molex Japan)

Terminal: 5556T

At other end:

Plug: 43020-0401

Terminal: 43031-0004

4.4.2 Servomotor Dimensional Drawings: European Safety Standards

The dimensional drawings of the Servomotors are broadly grouped into the following four categories depending on the type of encoder and whether a brake is used.

- Incremental Encoders without Brakes
- Incremental Encoders with Brakes
- Incremental Encoders without Brakes, but with Reduction Gears
- Incremental Encoders with Brakes and Reduction Gears

Incremental Encoders without Brakes (Type SGMM-□□S31□)

• 10 W, 20 W

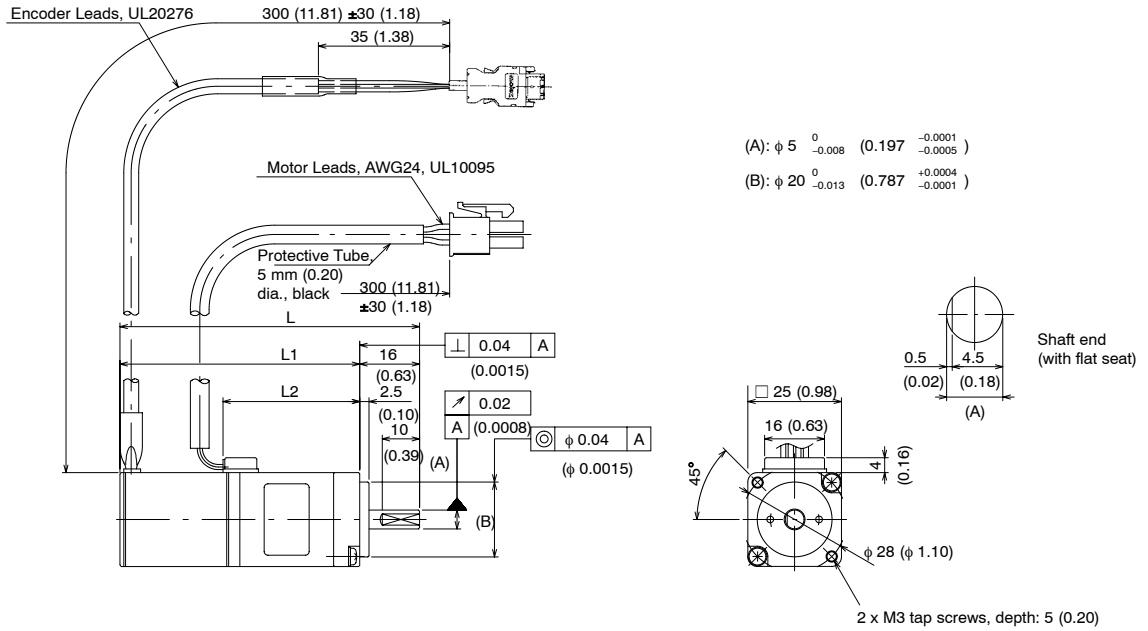

4

Type SGMM-	Shaft End Specifications	L mm (in)	L1 mm (in)	L2 mm (in)	Allowable Radial Load N (lb)	Allow-able Thrust Load N (lb)
A1S312	No flat seat	70 (2.76)	54 (2.13)	26.5 (1.04)	34.3 (7.7)	14.7 (3.3)
A1S313	With flat seat					
A2S312	No flat seat	80 (3.15)	64 (2.52)	36.5 (1.44)	44.1 (9.9)	
A2S313	With flat seat					
A3S312	No flat seat	90 (3.54)	74 (2.91)	46.5 (1.83)		
A3S313	With flat seat					

- Note**
- 1) The detector uses a 2048 P/R incremental encoder.
 - 2) The allowable load is applied to the shaft end.

Incremental Encoders with Brakes (Type SGMM-□□S31□C)

• 10 W, 20 W

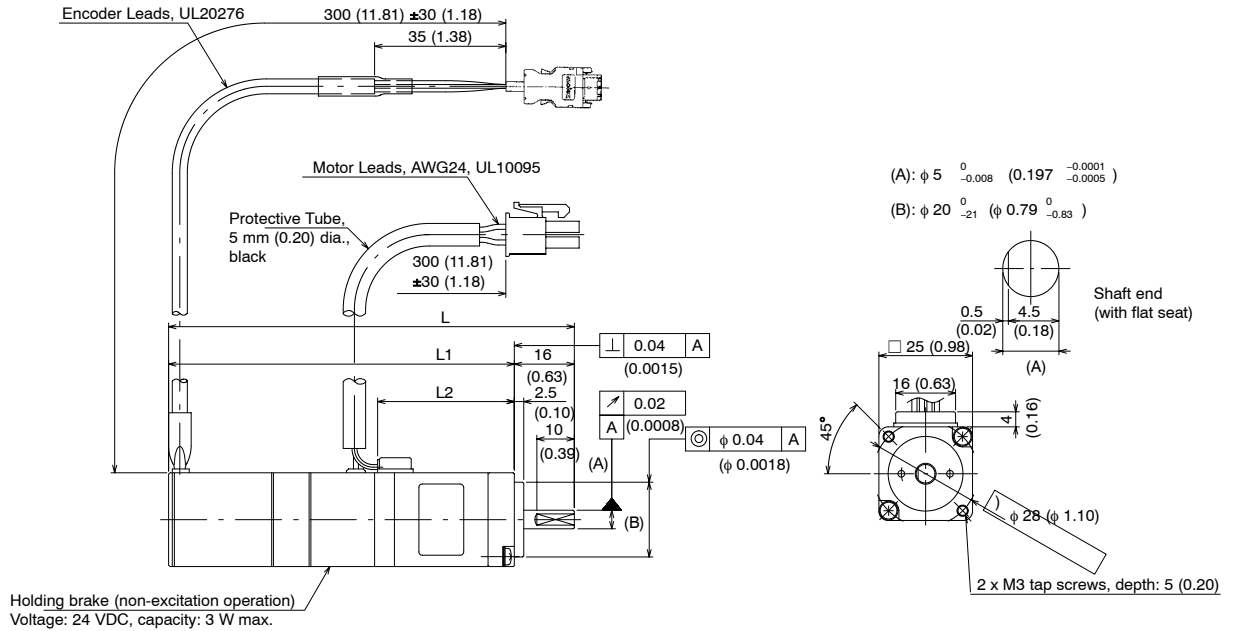

Type SGMM-	Shaft	L mm (in)	L1 mm (in)	L2 mm (in)	Allowable Radial Load N (lb)	Allowable Thrust Load N (lb)
A1S312C	No flat seat	94.5 (3.72)	78.5 (3.09)	26.5 (1.04)	34.3 (7.7)	14.7 (3.3)
A1S313C	With flat seat					
A2S312C	No flat seat	108.5 (4.27)	92.5 (3.64)	36.5 (1.44)	44.1 (9.9)	
A2S313C	With flat seat					
A3S312C	No flat seat	128.5 (5.06)	112.5 (4.43)	46.5 (1.83)		
A3S313C	With flat seat					

- Note**
- 1) The detector uses a 2048 P/R incremental encoder.
 - 2) The allowable load is applied to the shaft end.

**Incremental Encoders without Brakes but with Reduction Gears
(Model SGMM-□□S3J□□)**

• 10 W, 20 W

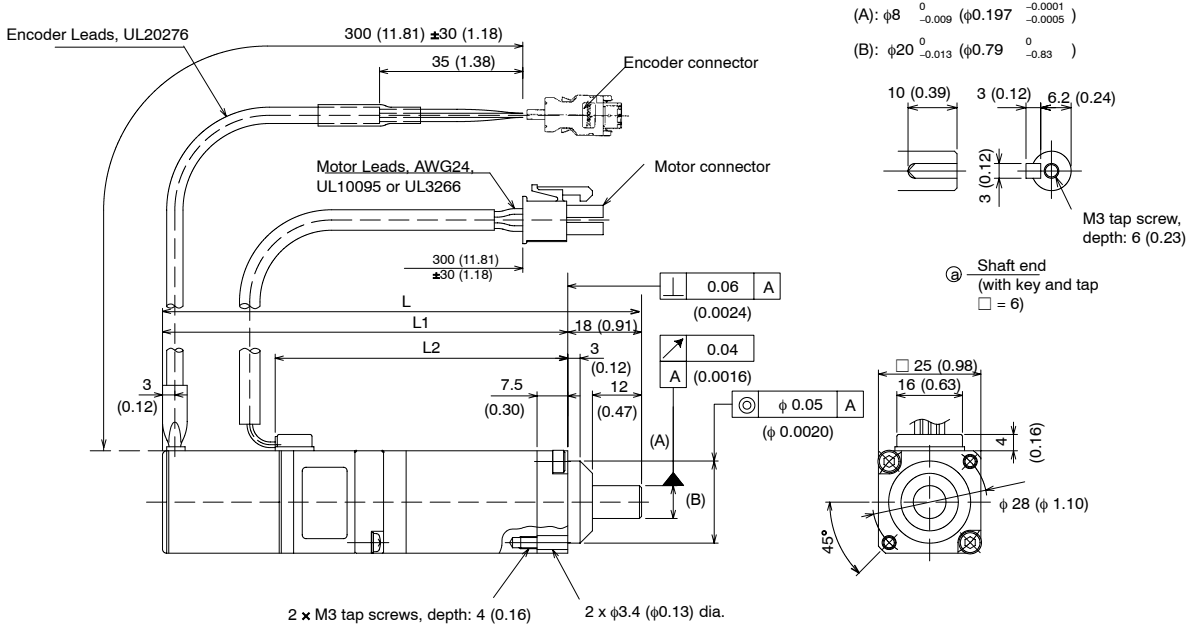

4

Model SGMM-	L mm (in)	L1 mm (in)	L2 mm (in)	Approx. Mass (g)
A1S3JA□	106.5 (4.19)	88.5 (3.48)	61 (2.4)	230
A1S3JB□	117 (4.61)	99 (3.9)	71.5 (2.81)	265
A1S3JC□				
A2S3JA□	116.5 (4.59)	98.5 (3.88)	71 (2.8)	270
A2S3JB□	127 (5)	109 (4.29)	81.5 (3.21)	305
A2S3JC□				

Model SGMM-	Reduction Gears			
	Gear Ratio	Allow-able Radial Load N (lb)	Allow-able Thrust Load N (lb)	Lost Motion
A1S3JA□	1/5	51.9 (11.67)	47.0 (10.57)	0.5 (deg)
A1S3JB□	1/16	76.4 (17.19)		
A1S3JC□	1/25	89.2 (20.07)		
A2S3JA□	1/5	51.9 (11.67)		
A2S3JB□	1/16	76.4 (17.19)		
A2S3JC□	1/25	89.2 (20.07)		

- Note**
- 1) The detector uses a 2048 P/R incremental encoder.
 - 2) The keyway complies with JIS B 1301-1976 (precision). A straight key is supplied (types with key only).
 - 3) The allowable load is applied to the shaft end.

• 30 W

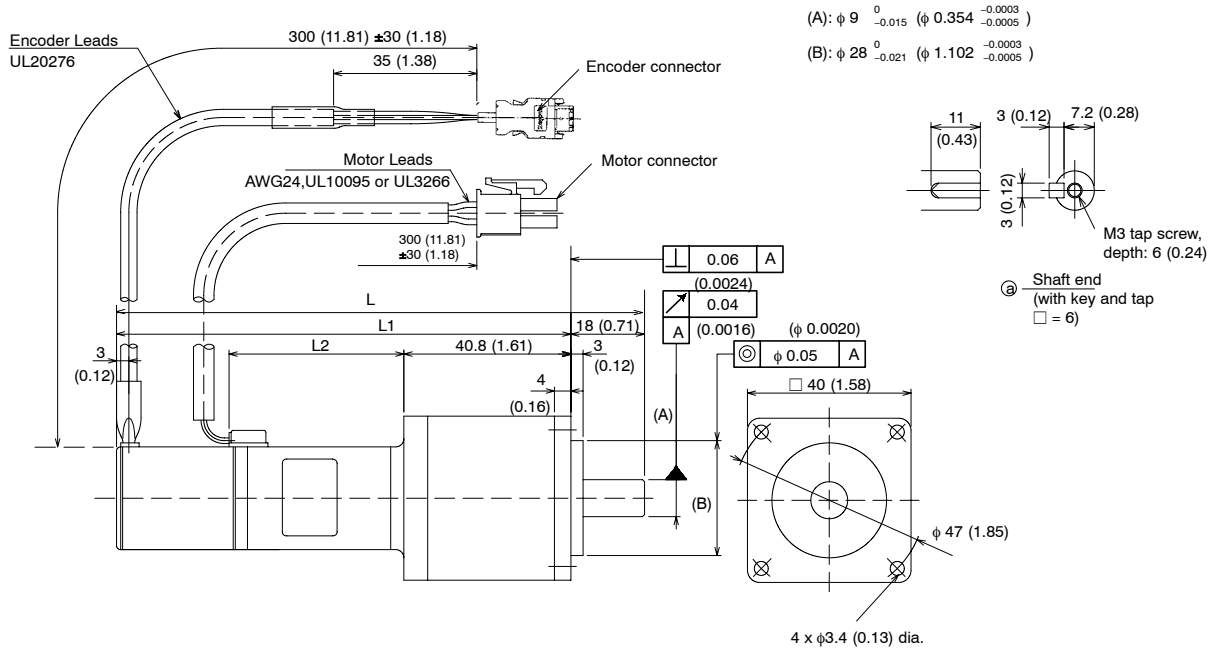

Model SGMM-	L mm (in)	L1 mm (in)	L2 mm (in)	Approx. Mass (g)
A3S3J1□	129 (5.08)	111 (4.37)	42.7 (1.68)	400
A3S3J2□				
A3S3J3□				

Model SGMM-	Reduction Gears			
	Gear Ratio	Allow-able Radial Load N (lb)	Allow-able Thrust Load N (lb)	Lost Motion
A3S3J1□	1/5	68.7 (15.46)	58.8 (13.23)	0.5 (deg)
A3S3J2□	1/16	147 (33.1)		
A3S3J3□	1/25	186 (41.9)		

- Note**
- 1) The detector uses a 2048 P/R incremental encoder.
 - 2) The keyway complies with JIS B 1301-1976 (precision). A straight key is supplied (types with key only).
 - 3) The allowable load is applied to the shaft end.

**Incremental Encoders with Brakes and Reduction Gears
(Model SGMM-□□S3J□□□)**

• 10 W, 20 W

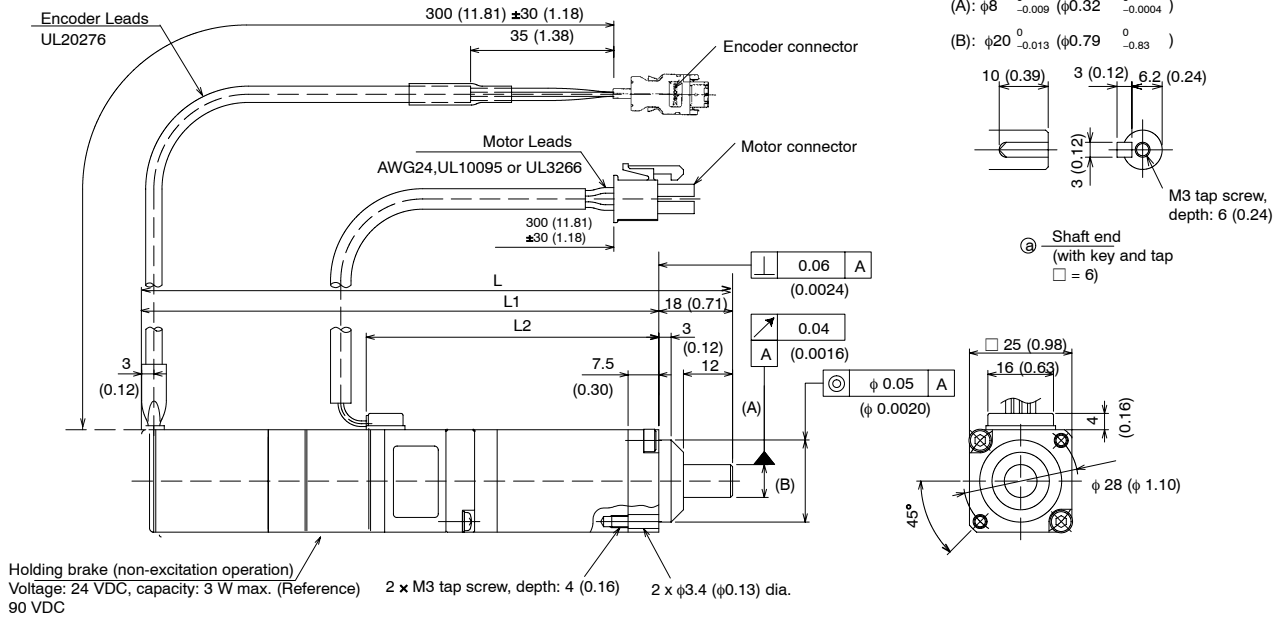

4

Model SGMM-	L mm (in)	L1 mm (in)	L2 mm (in)	Approx. Mass (g)
A1S3JA□□	131 (5.16)	113 (4.45)	61 (2.4)	315
A1S3JB□□	145.5 (5.73)	127.5 (5.02)	71.5 (2.81)	350
A1S3JC□□				
A2S3JA□□	141 (5.55)	123 (4.84)	71 (2.8)	370
A2S3JB□□	155.5 (6.12)	137.5 (5.41)	81.5 (3.21)	405
A2S3JC□□				

Model SGMM-	Reduction Gears			
	Gear Ratio	Allow-able Radial Load N (lb)	Allow-able Thrust Load N (lb)	Lost Motion
A1S3JA□□	1/5	51.9 (11.67)	47.0 (10.57)	0.5 (deg)
A1S3JB□□	1/16	76.4 (17.19)		
A1S3JC□□	1/25	89.2 (20.07)		
A2S3JA□□	1/5	51.9 (11.67)		
A2S3JB□□	1/16	76.4 (17.19)		
A2S3JC□□	1/25	89.2 (20.07)		

- Note**
- 1) The detector uses a 2048 P/R incremental encoder.
 - 2) The keyway complies with JIS B 1301-1976 (precision). A straight key is supplied (types with key only).
 - 3) The allowable load is applied to the shaft end.
 - 4) The electromagnetic brake is only to hold the load in position and cannot be used to stop the motor.

• 30 W

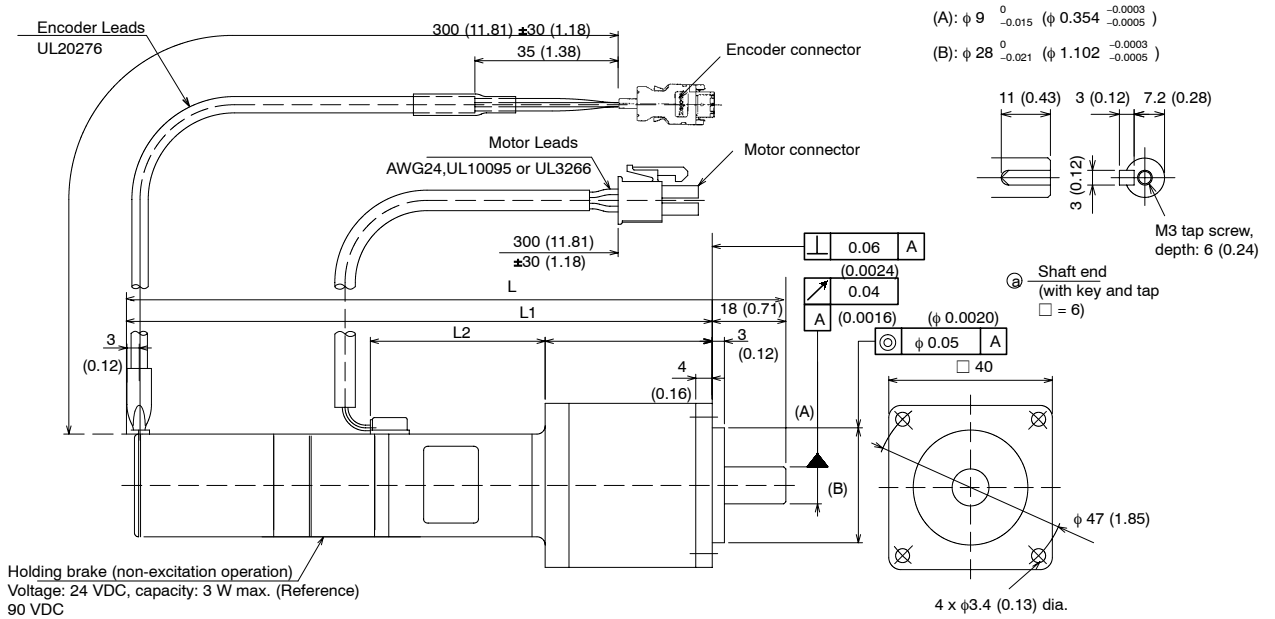

4

Model SGMM-	L mm (in)	L1 mm (in)	L2 mm (in)	Approx. Mass (g)
A3S3J1□□	167.5 (6.59)	149.5 (5.89)	52.7 (2.07)	545
A3S3J2□□				
A3S3J3□□				

Model SGMM-	Reduction Gears			
	Gear Ratio	Allow-able Radial Load N (lb)	Allow-able Thrust Load N (lb)	Lost Motion
A3S3J1□□	1/5	68.7 (15.45)	58.8 (13.23)	0.5 (deg)
A3S3J2□□	1/16	147 (33.07)		
A3S3J3□□	1/25	186 (41.85)		

- Note**
- 1) The detector uses a 2048 P/R incremental encoder.
 - 2) The keyway complies with JIS B 1301-1976 (precision). A straight key is supplied (types with key only).
 - 3) The allowable load is applied to the shaft end.
 - 4) The electromagnetic brake is only to hold the load in position and cannot be used to stop the motor.

• Encoder Plugs (Common)

Incremental Encoder Connection Specifications

1	A channel output	Blue
2	/A channel output	Blue/Black
3	B channel output	Yellow
4	/B channel output	Yellow/Black
5	C channel output	Green
6	/C channel output	Green/Black
7	0 V (power supply)	Gray
8	+5 V (power supply)	Red
9	FG (frame ground)	Orange

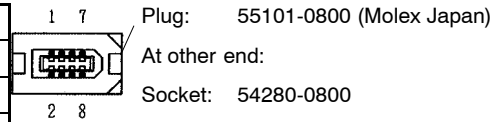

• Motor Plugs

Motor Connection Specifications: Without Brake

1	Phase U	Red
2	Phase V	White
3	Phase W	Blue
4	FG	Green

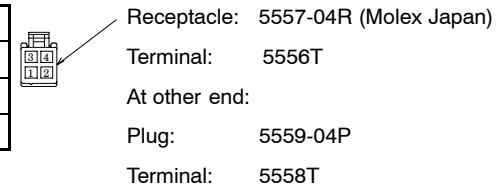

Motor Connection Specifications: With Brake

1	Phase U	Red
2	Phase V	White
3	Phase W	Blue
4	FG	Green
5	Brake	Black
6	Brake	Black

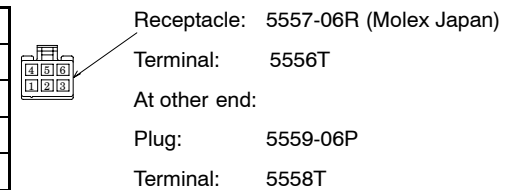

4

4.4.3 Servopack Dimensional Drawings

The following diagram shows the external dimensions of the Servopack.

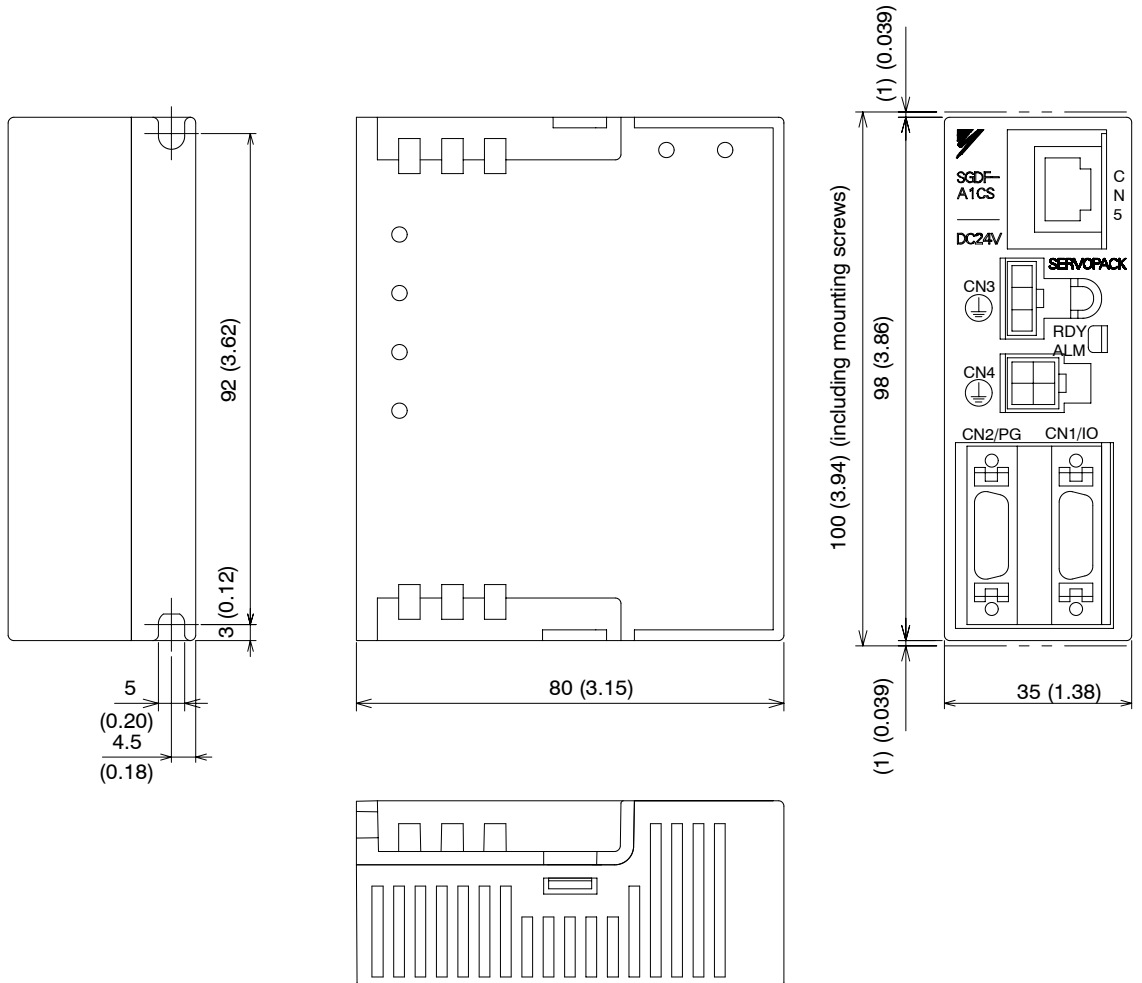

Approx. Mass: 0.3 kg (0.66 lb)

4.4.4 Digital Operator Dimensional Drawings

The following diagram shows the external dimensions of the Digital Operator.

JUSP-OP02A-3

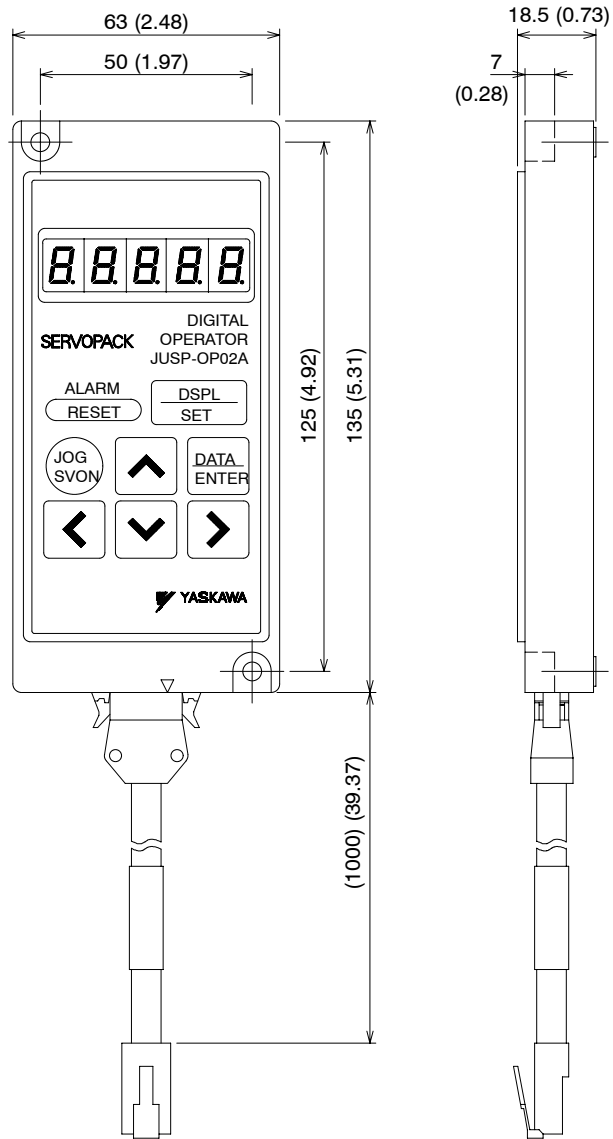

Approx. Mass: 0.18 kg (0.40 lb)

4

4.5 Selecting Peripheral Devices

■ This section shows how to select peripheral devices using flowcharts.

4.5.1 Selecting Peripheral Devices

Select the peripheral devices using the flowcharts on the subsequent pages.

The following items are not included in the flowcharts. Refer to *4.6 Specifications and Dimensional Drawings of Peripheral Devices*.

- Variable resistors for speed setting
- Encoder signal converter units
- Cables for connecting PC and Servopack

Peripheral Device Selection Flowchart

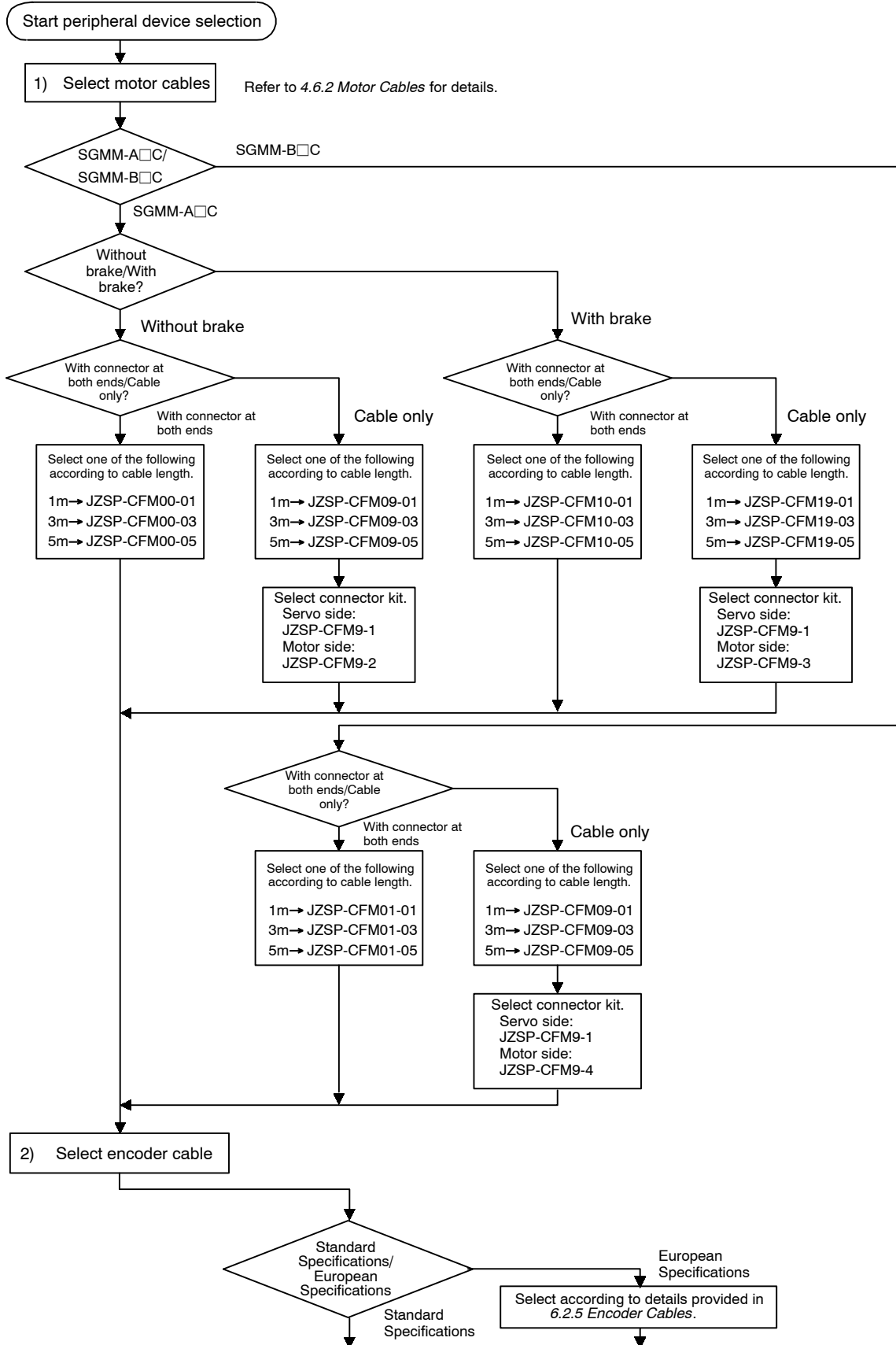

4

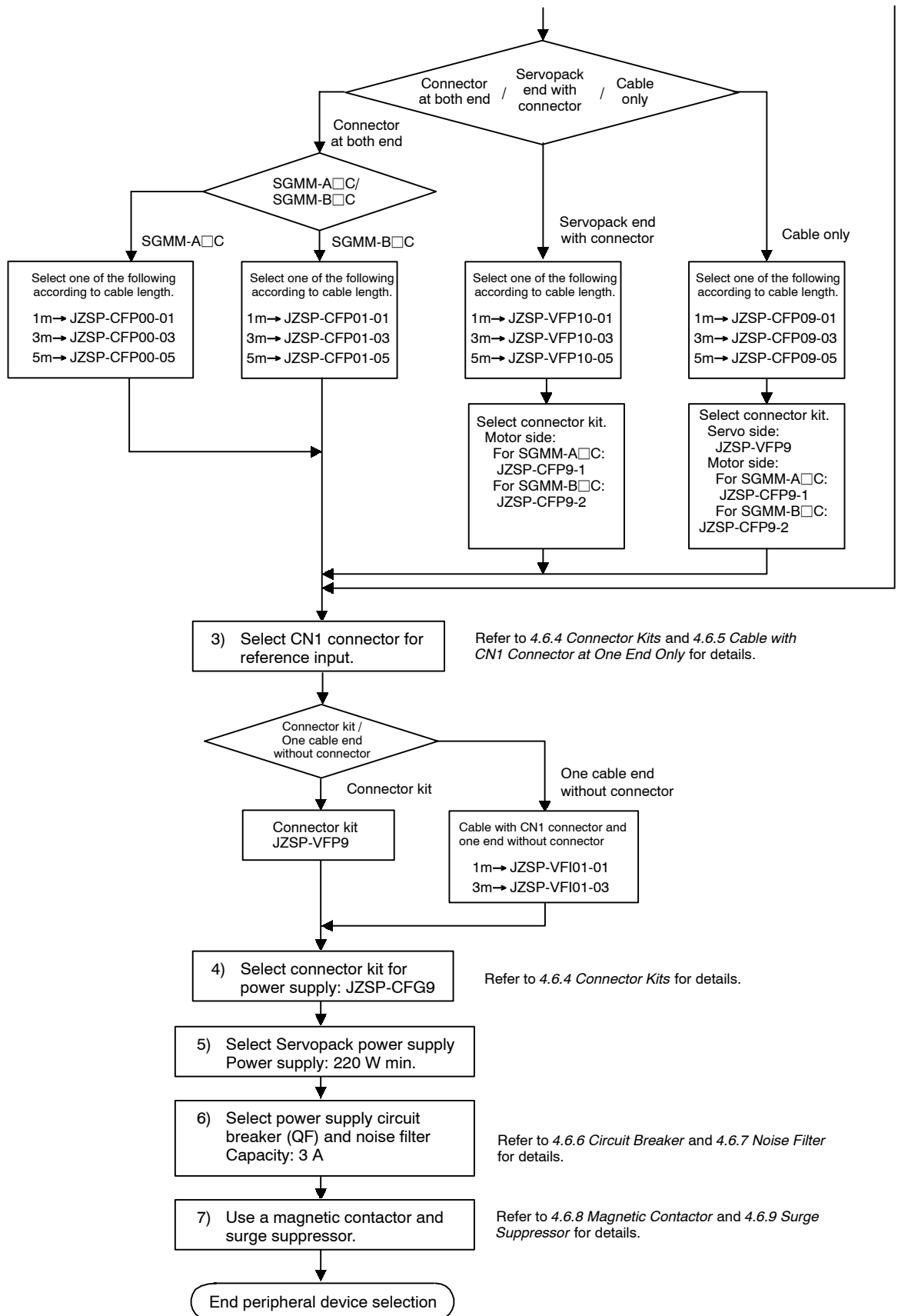

4.6 Specifications and Dimensional Drawings of Peripheral Devices

This section provides the specifications and dimensional drawings of the peripheral devices required for the servo system. The sequence of peripheral devices is given by the Flowchart for Peripheral Device Selection Flowchart in 4.5.1 *Selecting Peripheral Devices*.

4.6.1 Cable Specifications and Peripheral Devices

The rated current of the Servopack external terminals, cable size, and peripheral devices are listed in the next table. The cable specifications and size are selected according to the operating environment and current capacity. The cable specifications were selected under conditions of three cables per bundle at 40°C ambient temperature, with the rated current flowing.

Servopack Type SGDF-	Main Circuit Power Input Terminal 24 VDC, GND		Motor Connection Terminals U, V, W, 		Power Supply Capacity per Servopack* W*2	MCCB or Fuse Capacity A*3	Recommended Noise Filter*4		Magnetic Contactor	Power Supply Capacity to Servopack (W)*5
	Rated Current A(rms)	Cable Spec.	Rated Current A(rms)	Cable Spec.			Type	Spec.		
A1C□	1.2	0.5 mm ² min.	2.1	*1	28	5	LF-205A	Single-phase 200 VAC Class, 5 A	Yaskawa HI-15J5 (35 A), or equivalent	220
A2C□	1.7		2.0		42					
A3C□	2.3		2.9		60					
B3C□	0.9		1.3		22					
B5C□	1.0		1.3		24					
B9C□	1.2		1.9		30					

*1 Be sure to use Yaskawa cables.

*2 Value at rated load.

*3 Braking characteristics (at 25°C): 200% for 2 s min., 700% for 0.01 s min.

*4 Yaskawa recommends noise filters manufactured by Tokin Corp. Yaskawa Controls Co., Ltd. can supply these noise filters.

*5 Power supply capacity required for maximum load.

The types of cable are shown in the following table.

Cable Type		Conductor Allowable Temperature °C
Symbol	Name	
PVC	Normal vinyl cable	---
---	Heat-resistant vinyl cable	80

- Note**
- 1) Use cable with 60 V min. withstand voltage for main circuits.
 - 2) Consider allowable current reduction ratio if cables are bundled in PVC or metal ducts.
 - 3) Use heat-resistant cable under high ambient or panel temperature where normal vinyl cables rapidly deteriorate.

4.6.2 Motor Cables

The dimensions and appearance of the motor cables are shown below. Specify the cable type when ordering.

SGMM-A

- With Connector at Both Ends
- Without Brake

Type	L mm (feet)
JZSP-CFM00-01	1000 ⁺¹⁰⁰ ₀ (3.3 ^{+0.33} ₀)
JZSP-CFM00-03	3000 ⁺¹⁰⁰ ₀ (10 ^{+0.33} ₀)
JZSP-CFM00-05	5000 ⁺¹⁰⁰ ₀ (16.7 ^{+0.33} ₀)

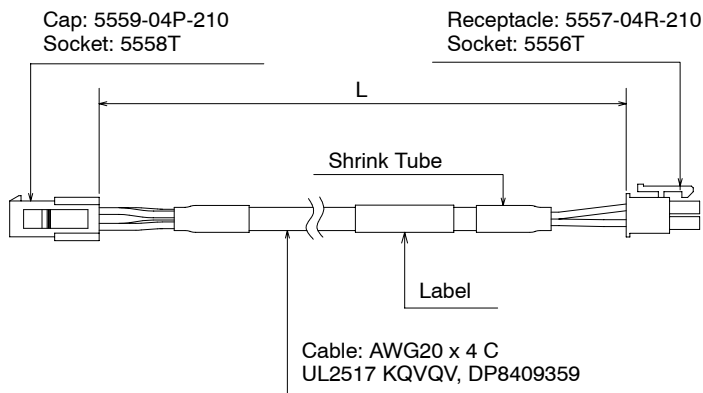

- With Brake

Type	L mm (feet)
JZSP-CFM10-01	1000 $\begin{smallmatrix} +100 \\ 0 \end{smallmatrix}$ (3.3 $\begin{smallmatrix} +0.33 \\ 0 \end{smallmatrix}$)
JZSP-CFM10-03	3000 $\begin{smallmatrix} +100 \\ 0 \end{smallmatrix}$ (10 $\begin{smallmatrix} +0.33 \\ 0 \end{smallmatrix}$)
JZSP-CFM10-05	5000 $\begin{smallmatrix} +100 \\ 0 \end{smallmatrix}$ (16.7 $\begin{smallmatrix} +0.33 \\ 0 \end{smallmatrix}$)

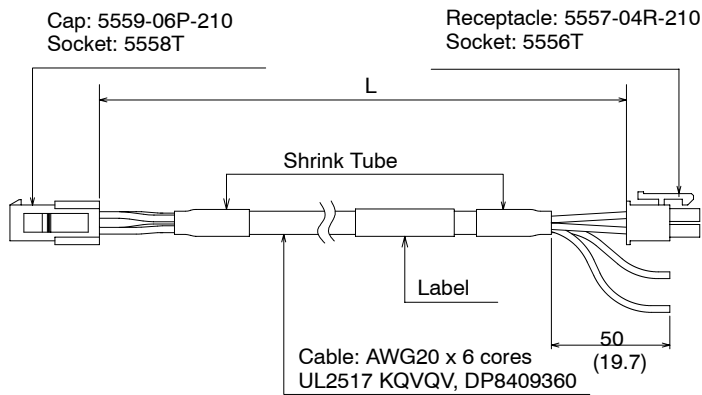

- Cable only

- Without Brake

Type	L mm (feet)
JZSP-CFM09-01	1000 $\begin{smallmatrix} +100 \\ 0 \end{smallmatrix}$ (3.3 $\begin{smallmatrix} +0.33 \\ 0 \end{smallmatrix}$)
JZSP-CFM09-03	3000 $\begin{smallmatrix} +100 \\ 0 \end{smallmatrix}$ (10 $\begin{smallmatrix} +0.33 \\ 0 \end{smallmatrix}$)
JZSP-CFM09-05	5000 $\begin{smallmatrix} +100 \\ 0 \end{smallmatrix}$ (16.7 $\begin{smallmatrix} +0.33 \\ 0 \end{smallmatrix}$)

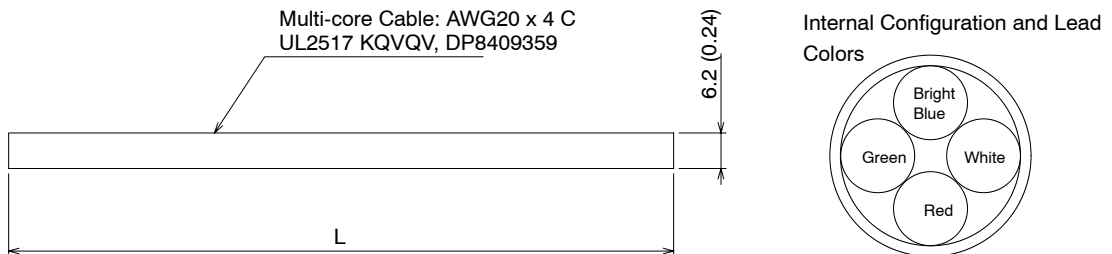

4

- With Brake

Type	L mm (feet)
JZSP-CFM19-01	1000 ⁺¹⁰⁰ ₀ (3.3 ^{+0.33} ₀)
JZSP-CFM19-03	3000 ⁺¹⁰⁰ ₀ (10 ^{+0.33} ₀)
JZSP-CFM19-05	5000 ⁺¹⁰⁰ ₀ (16.7 ^{+0.33} ₀)

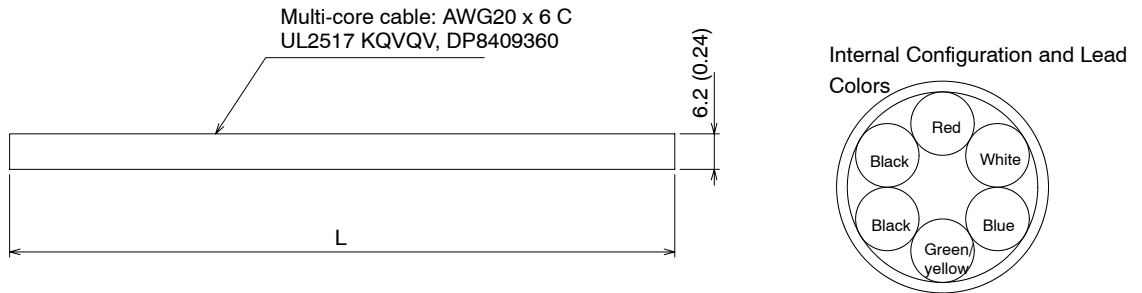

- * If cable only is ordered, purchase the Molex connector separately. Refer to 4.6.4 Connector Kits for details.

SGMM-B

- With Connector at Both Ends

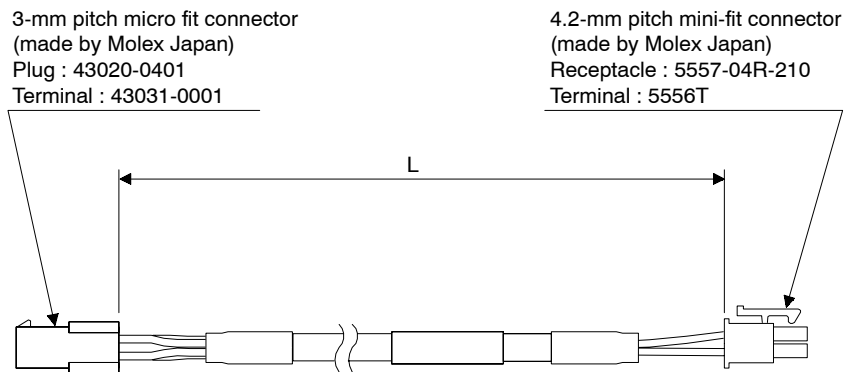

4.6.3 Encoder Cables

- Cable only

Type	L mm (feet)
JZSP-CFM09-01	1000 $\begin{smallmatrix} +100 \\ 0 \end{smallmatrix}$ (3.3 $\begin{smallmatrix} +0.33 \\ 0 \end{smallmatrix}$)
JZSP-CFM09-03	3000 $\begin{smallmatrix} +100 \\ 0 \end{smallmatrix}$ (10 $\begin{smallmatrix} +0.33 \\ 0 \end{smallmatrix}$)
JZSP-CFM09-05	5000 $\begin{smallmatrix} +100 \\ 0 \end{smallmatrix}$ (16.7 $\begin{smallmatrix} +0.33 \\ 0 \end{smallmatrix}$)

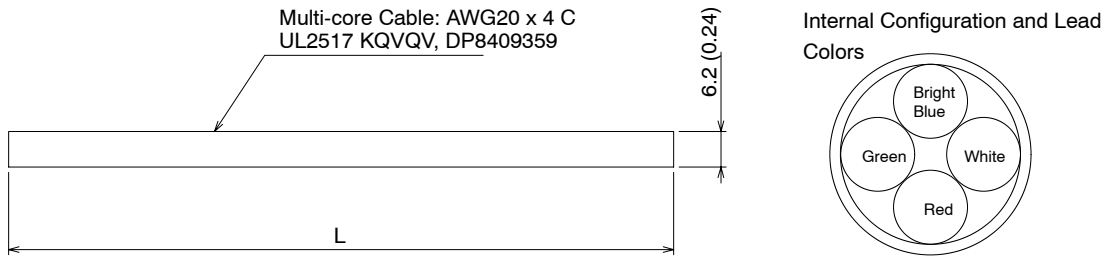

4.6.3 Encoder Cables

The dimensions and appearance of the encoder cables are shown below. Specify the cable type when ordering.

With Connector at Both Ends

- SGDF-A□C□

Type	L mm (feet)
JZSP-CFP00-01	1000 $\begin{smallmatrix} +100 \\ 0 \end{smallmatrix}$ (3.3 $\begin{smallmatrix} +0.33 \\ 0 \end{smallmatrix}$)
JZSP-CFP00-03	3000 $\begin{smallmatrix} +100 \\ 0 \end{smallmatrix}$ (10 $\begin{smallmatrix} +0.33 \\ 0 \end{smallmatrix}$)
JZSP-CFP00-05	5000 $\begin{smallmatrix} +100 \\ 0 \end{smallmatrix}$ (16.7 $\begin{smallmatrix} +0.33 \\ 0 \end{smallmatrix}$)

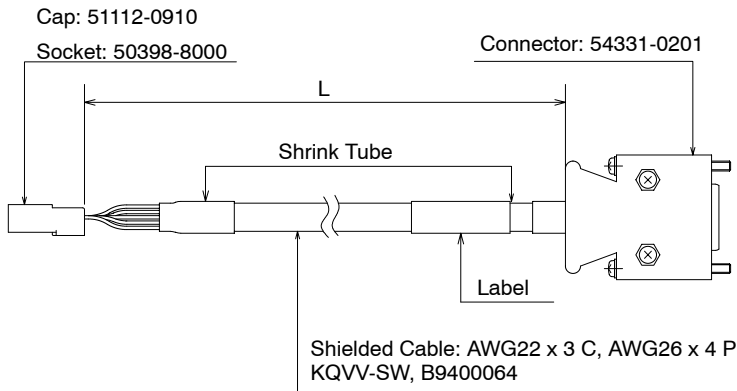

• SGDF-B□C□

Type	L mm (feet)
JZSP-CFP01-01	1000 $\begin{smallmatrix} +100 \\ 0 \end{smallmatrix}$ (3.3 $\begin{smallmatrix} +0.33 \\ 0 \end{smallmatrix}$)
JZSP-CFP01-03	3000 $\begin{smallmatrix} +100 \\ 0 \end{smallmatrix}$ (10 $\begin{smallmatrix} +0.33 \\ 0 \end{smallmatrix}$)
JZSP-CFP01-05	5000 $\begin{smallmatrix} +100 \\ 0 \end{smallmatrix}$ (16.7 $\begin{smallmatrix} +0.33 \\ 0 \end{smallmatrix}$)

3-mm pitch micro fit connector
 (made by Molex Japan)
 Plug : 43020-0401
 Terminal : 43031-0001, 43031-0004

1.27-mm pitch I/O connector
 (made by Molex Japan)
 Cable housing assembly : 54331-0201
 Plug connector : 54306-2011

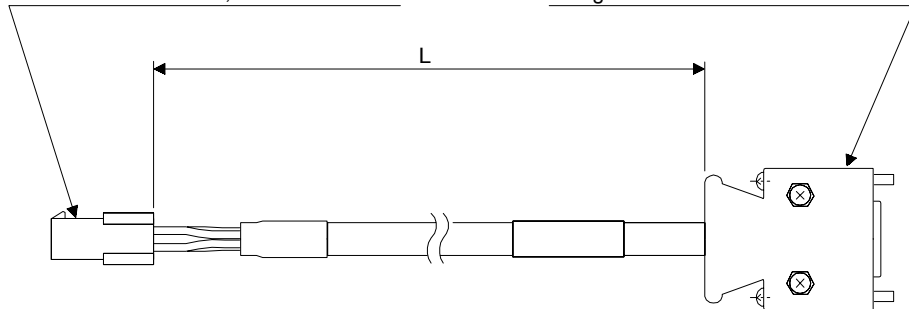

No Connector at Motor End

Type	L mm (feet)
JZSP-VFP01-01	1000 $\begin{smallmatrix} +100 \\ 0 \end{smallmatrix}$ (3.3 $\begin{smallmatrix} +0.33 \\ 0 \end{smallmatrix}$)
JZSP-VFP01-03	3000 $\begin{smallmatrix} +100 \\ 0 \end{smallmatrix}$ (10 $\begin{smallmatrix} +0.33 \\ 0 \end{smallmatrix}$)
JZSP-VFP01-05	5000 $\begin{smallmatrix} +100 \\ 0 \end{smallmatrix}$ (16.7 $\begin{smallmatrix} +0.33 \\ 0 \end{smallmatrix}$)

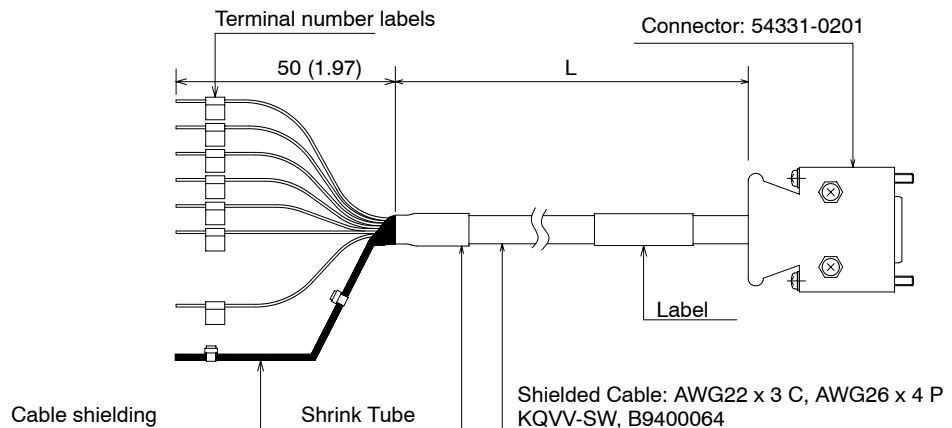

Cable Only

Type	L mm (feet)
JZSP-CFP09-01	1000 $\begin{smallmatrix} +100 \\ 0 \end{smallmatrix}$ (3.3 $\begin{smallmatrix} +0.33 \\ 0 \end{smallmatrix}$)
JZSP-CFP09-03	3000 $\begin{smallmatrix} +100 \\ 0 \end{smallmatrix}$ (10 $\begin{smallmatrix} +0.33 \\ 0 \end{smallmatrix}$)
JZSP-CFP09-05	5000 $\begin{smallmatrix} +100 \\ 0 \end{smallmatrix}$ (16.7 $\begin{smallmatrix} +0.33 \\ 0 \end{smallmatrix}$)

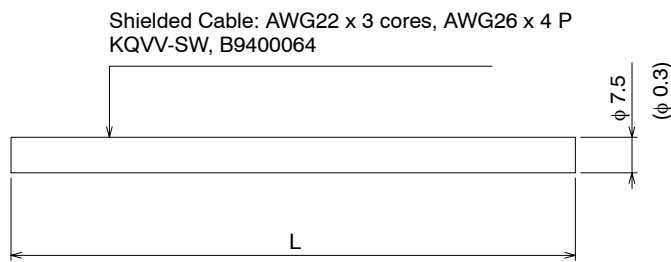

Internal Configuration and Lead Colors

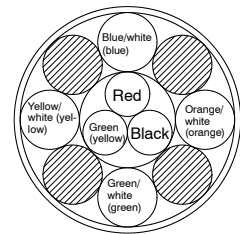

4

* If cable only is ordered, purchase the Molex connectors separately. Refer to 4.6.4 Connector Kits for details.

Cables prepared by Yaskawa are 1 m, 3 m, or 5 m in length. The maximum allowable length between the Servopack and Servomotor (PG) is 5 m.

4.6.4 Connector Kits

Power Supply Connector Kit

Type: JZSP-CFG9

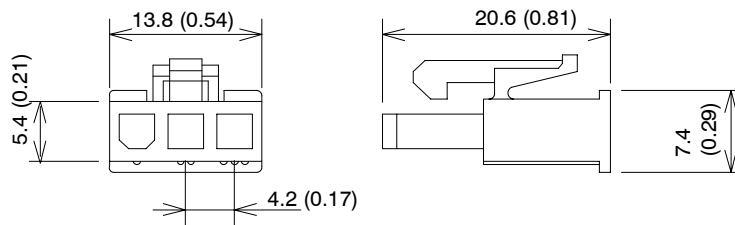

Receptacle: 5557-03R2-210 (made by Molex Japan)

Socket: 5556TL (made by Molex Japan)

Motor Connector Kit

• SGDF-A□C□

• Without Brake

• Servo End

Type: JZSP-CFM9-1

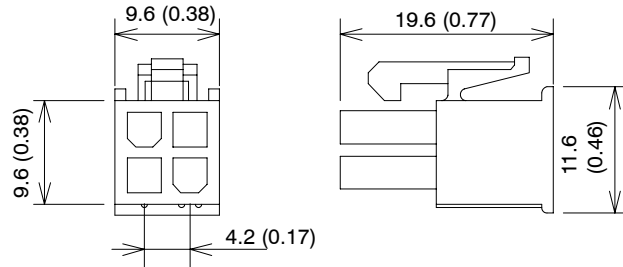

Receptacle: 5557-04R-210 (made by Molex Japan)

Socket: 5556TL (made by Molex Japan)

• Motor End

Type: JZSP-CFM9-2

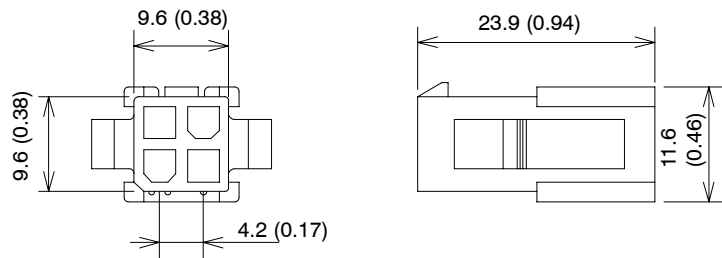

Plug: 5559-04P-210 (made by Molex Japan)

Socket: 5558TL (made by Molex Japan)

• With Brake

• Servo End

Type: JZSP-CFM9-1

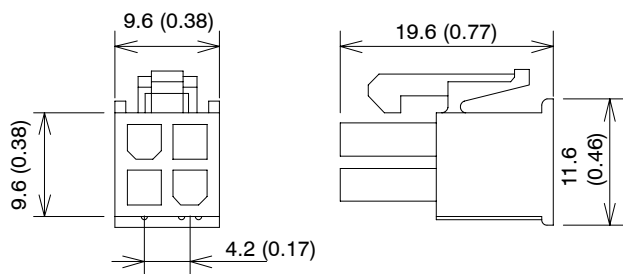

Receptacle: 5557-04R-210 (made by Molex Japan)

Socket: 5556TL (made by Molex Japan)

• Motor End

Type: JZSP-CFM9-3

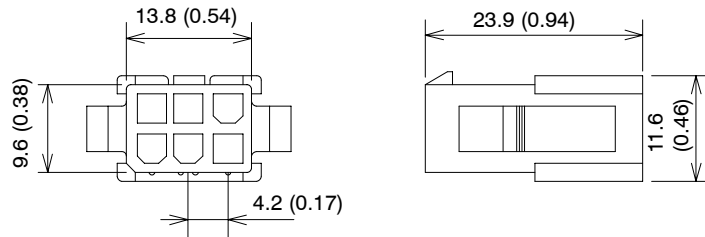

Plug: 5559-06P-210 (made by Molex Japan)

Socket: 5558TL (made by Molex Japan)

• SGDF-B□C□

Type: JZSP-CFM9-4

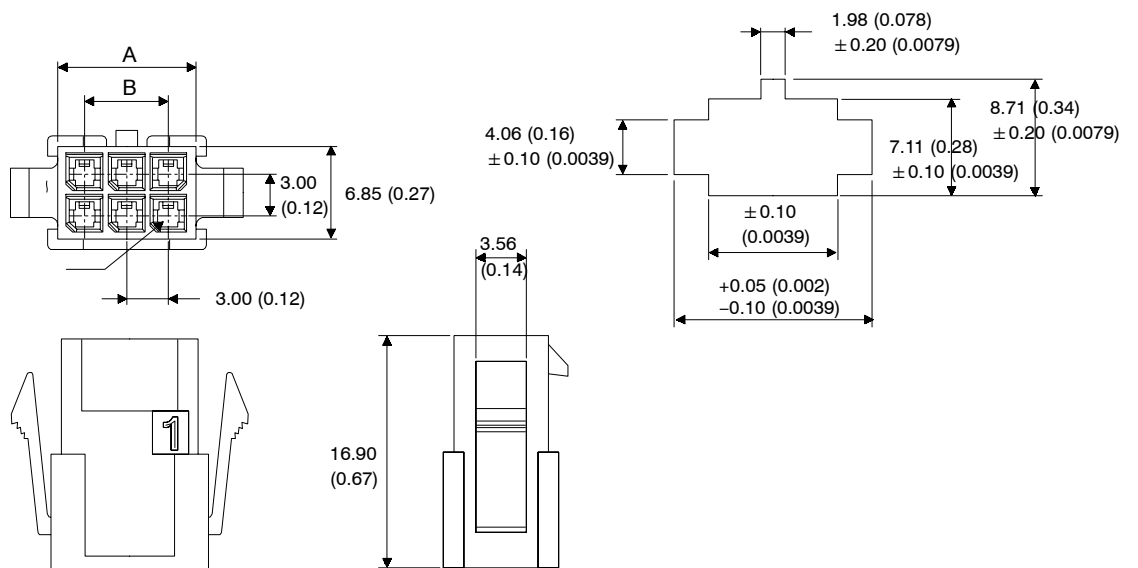

Plug: 43020-0401 (made by Molex Japan)

Socket: 43031-0001 (made by Molex Japan)

Encoder Connector Kit

- SGMM-A□C

- Servo End

Type: JZSP-VFP9

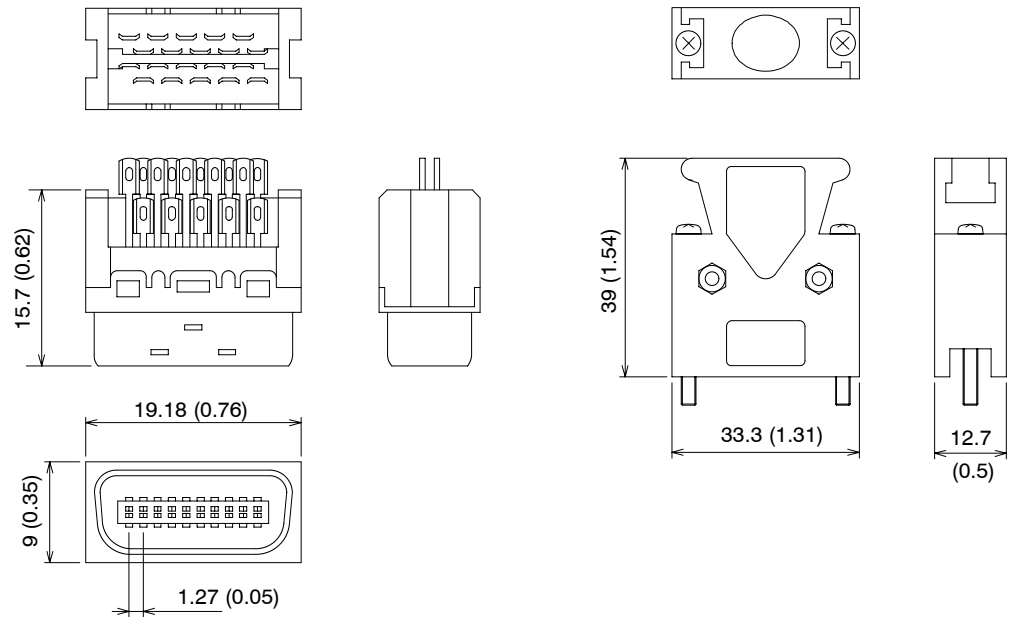

Plug and Shell: 54331-0201 (made by Molex Japan)

- Motor End

Type: JZSP-CFP9-1

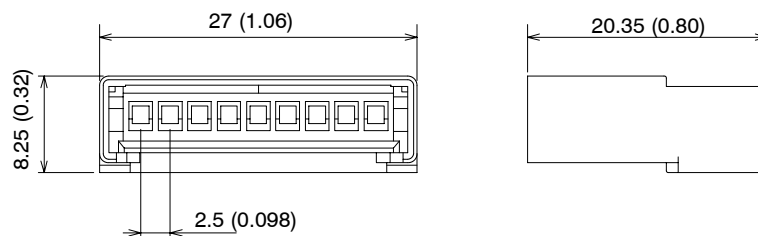

Plug: 51112-0910 (made by Molex Japan)

Socket: 50398-8100 (made by Molex Japan)

- SGMM-B□C

- Servo End

Type: JZSP-VFP9

Plug: 43020-10001 (made by Molex Japan)

Socket: 43031-0001 (made by Molex Japan)

- Motor End

Type: JZSP-VFP9-2

Plug: 43020-10001 (made by Molex Japan)

Socket: 43031-0001 (made by Molex Japan)

Input Reference Connector Kit

- Servo End

Type: JZSP-VFP9

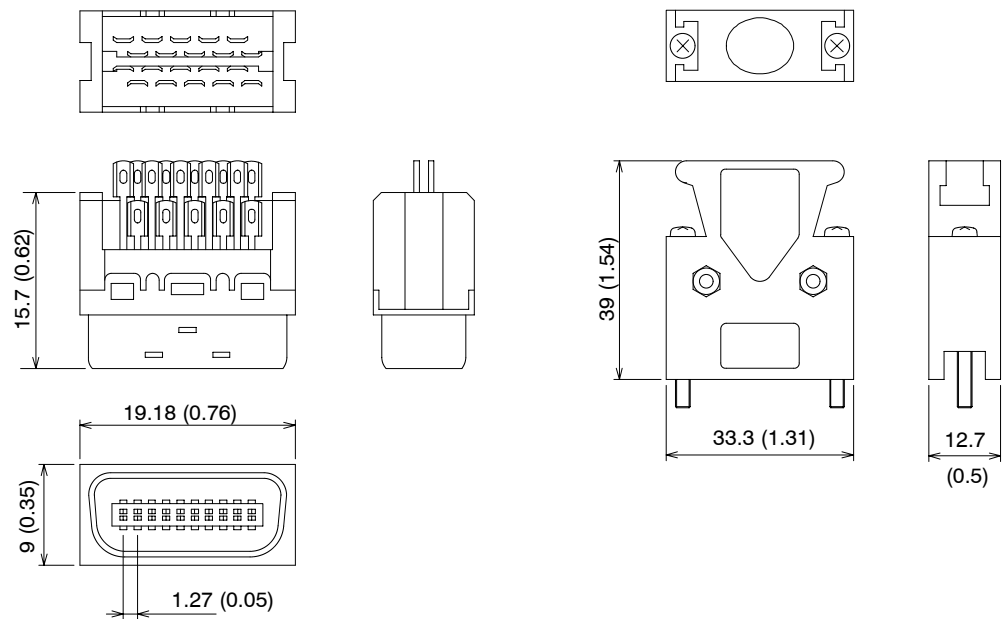

Plug and Shell: 54331-0201 (made by Molex Japan)

4.6.5 Cable with CN1 Connector at One End Only

The following cables do not have a connector at the host controller end. The loose wires at the host controller end are labelled with the terminal numbers.

Type	L mm (feet)
JZSP-VFI01-01	1000 $\begin{matrix} +100 \\ 0 \end{matrix}$ (3.3 $\begin{matrix} +0.33 \\ 0 \end{matrix}$)
JZSP-VFI01-03	3000 $\begin{matrix} +100 \\ 0 \end{matrix}$ (10 $\begin{matrix} +0.33 \\ 0 \end{matrix}$)

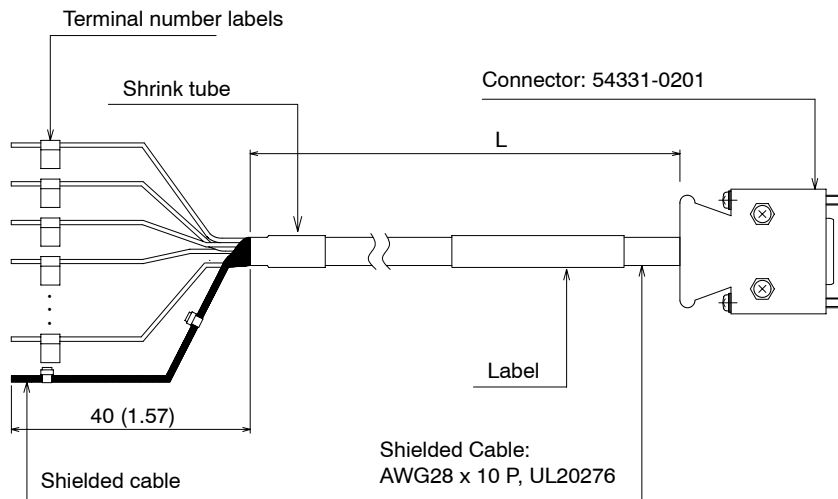

4

4.6.6 Circuit Breaker

The customer should purchase a circuit breaker (MCCB) of appropriate capacity to protect the power lines.

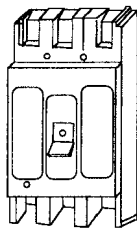

• Recommended Product

Ground fault detector for motor protection manufactured by Mitsubishi Electric Co. Ltd.
 Type: MN50-CF
 Rated Current: 7.1 A

4.6.7 Noise Filter

Install the following noise filter to prevent external noise from the power lines.

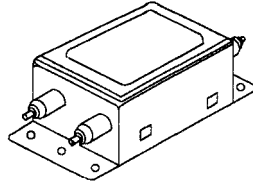

Servopack Capacity	Noise Filter Type
10 W, 20 W, 30 W	LF-205A

- LF-205A (Single-phase 200 VAC Class, 5 A)

4

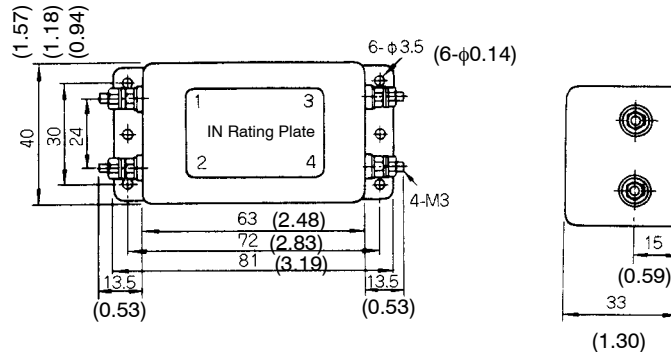

4.6.8 Magnetic Contactor

The magnetic contactor is used to turn the servo power supply ON and OFF. Always attach a surge suppressor to the magnetic contactor before using.

Use one 20-A magnetic contactor of the type shown below for a single Σ Series, regardless of capacity. For multiple servo systems, select the magnetic contactor according to the total capacity.

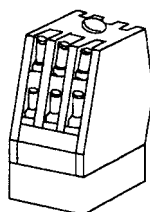

Type: HI-11J (20 A)

External Dimensions and Terminal Symbols for the Magnetic Contactor

Model	External Dimensions [mm (in)]	Mounting Hole Dimensions [mm (in)]	Terminal Symbols
HI-11J HI-14J	<p>Coil terminal M3.5</p> <p>Auxiliary contact terminal M3.5</p> <p>Main contact terminal M3.5</p> <p>Approx. mass: 0.25 kg (0.551 lb)</p>	<p>2xM4 mounting holes</p>	<p>Auxiliary NO contact</p> <p>aA1 — o — A2 b</p> <p>R 1 S 3 T 5 1 13</p> <p>U 2 V 4 W 6 2 14</p> <p>Auxiliary NC contact</p> <p>aA1 — o — A2 b</p> <p>R 1 S 3 T 5 1 11</p> <p>U 2 V 4 W 6 2 12</p>
HI-15J HI-18J	<p>Coil terminal M3.5</p> <p>Auxiliary contact terminal M3.5</p> <p>Main contact terminal M4</p> <p>Approx. mass: 0.38 kg (0.838 lb)</p>	<p>2xM4 mounting holes</p>	<p>Auxiliary NO contact/ Auxiliary NC contact</p> <p>aA1 — o — A2 b</p> <p>R 1 S 3 T 5 1 21 3 13</p> <p>U 2 V 4 W 6 2 22 4 14</p>
HI-20J	<p>Coil terminal M3.5</p> <p>Auxiliary contact terminal M3.5</p> <p>Main contact terminal M4</p> <p>Approx. mass: 0.38 kg (0.838 lb)</p>	<p>2xM4 mounting holes</p>	<p>Auxiliary NO contact/ Auxiliary NC contact</p> <p>aA1 — o — A2 b</p> <p>R 1 S 3 T 5 1 41 3 23</p> <p>U 2 V 4 W 6 2 42 4 24</p>

4.6.9 Surge Suppressor

Attach a surge suppressor to the magnetic contactor to prevent power supply noise and protect contacts.

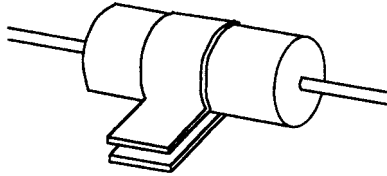

• Recommended Product

Spark Killer manufactured by Okaya Electric Industries Co., Ltd.
 Type: CR50500BL (250 VAC)
 Static Electricity Capacity: 0.5 μ F \pm 20%
 Resistance: 50 Ω (1/2 W) \pm 30%

4.6.10 Variable Resistor for Speed Setting

This variable resistor is used to give speed references by applying the speed reference voltage from the external power supply across CN1-12 and CN1-13.

4

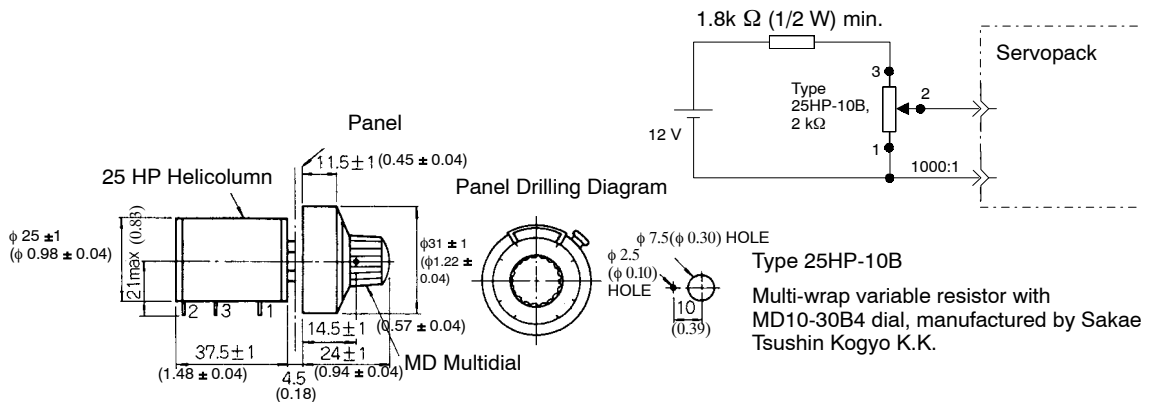

4.6.11 Encoder Signal Converter Unit

The Encoder Signal Converter Unit is used to convert the encoder signal output from the line driver to an open collector output or voltage pulse output.

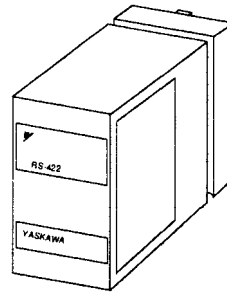

Terminal Numbers

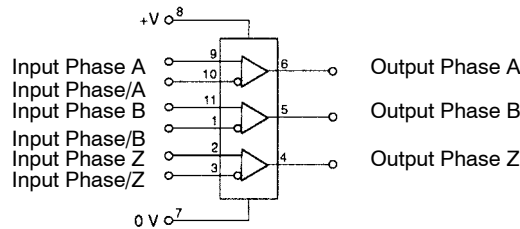

Dimensional Drawings

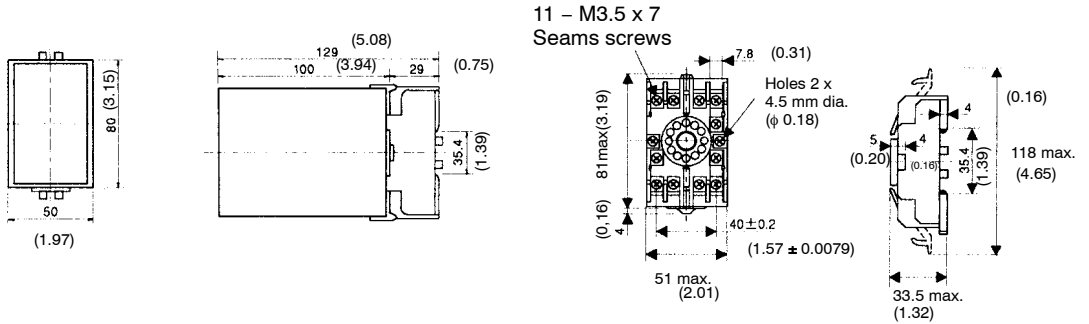

Specifications

Type	Receiver Unit			
Specifications	LRX-01/A1	LRX-01/A2	LRX-01/A3	LRX-01/A4
Power Supply	12 VDC \pm 10%, 100 mA		5 VDC \pm 5%, 100 mA	
Input Signals	Balanced line driver input (RS-422)			
Output Signals	Voltage pulse output	Open collector output	Voltage pulse output	Open collector output
Input Signal Level	Voltage differential \geq 0.3 V, internal termination resistance 100 Ω			
Output Signal Level	H: 10 V min. (1 mA) L: 0.5 V max. (30 mA)	L: 0.5 V max. (30 mA) Withstand voltage: 50 V	H: 3 V min. (1 mA) L: 0.5 V max. (30 mA)	L: 0.5 V max. (30 mA) Withstand voltage: 50 V
Operating Ambient Temperature Range	0 to +60°C			
IC Used	AM26LS32C Receiver IC, or equivalent			

4.6.12 Cables for Connecting PC and Servopack

Special cables are used to connect a PC to a Servopack. With these cables, parameters can be monitored and set with a PC.

Communications software that controls the Servodrive from a PC is available from Yaskawa. Contact your Yaskawa representative for more details, and operate the software as described in the manual supplied.

■ D-sub, 25-pin Connector Cable

Connecting a Personal Computer to a Servopack

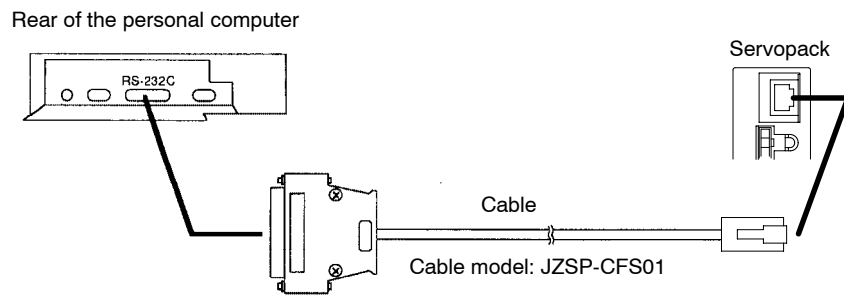

Cable Configuration

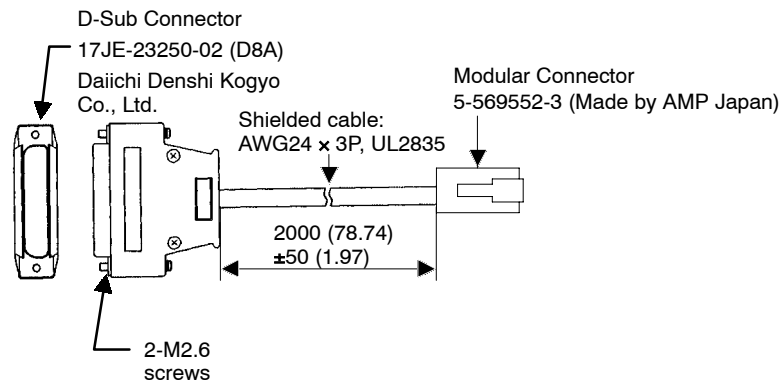

Communications Specifications

The communications specifications are as follows:

- Baud Rate: 9600 bps
- Number of Bits: Start: 1 bit
Data: 7 bits
Stop: 1 bit
Parity: 1 bit (even)
- Synchronization Method: Start-Stop
- XON/XOFF Control: None
- Shift Control: None
- Communications Method: Semi-duplex

Connection Circuits

• **With an RS-232C Port**

Maximum cable length is 2 m (6.56 ft). In this case, the connection circuit is as follows:

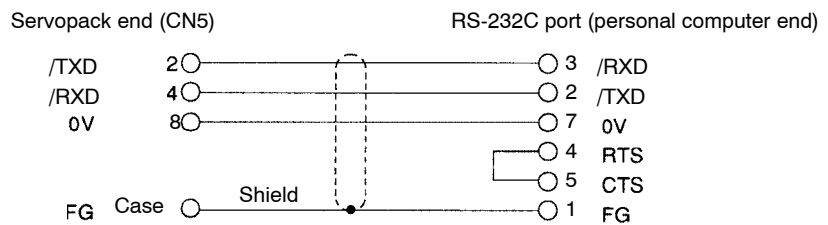

4

■ Other Cables for Connecting Personal Computers

Yaskawa also provides cables for connecting NEC PC98 Series and IBM PC compatible to a Servopack.

D-sub, 9-pin Connector Cable for IBM PC Compatible

The JZSP-CFS02 cable must be purchased at customer side.

• Cable Configuration

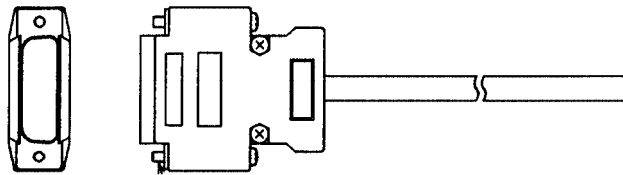

• Connecting Circuit

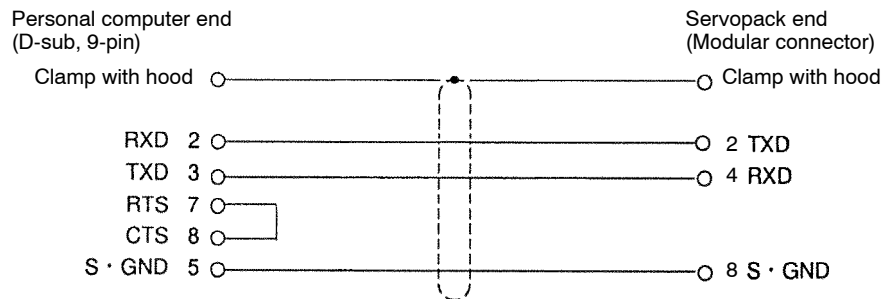

14-pin Half-pitch Connector Cable for NEC PC-98 Series PC

The JZSP-CFS02 cable must be purchased at customer side.

• **Cable Configuration**

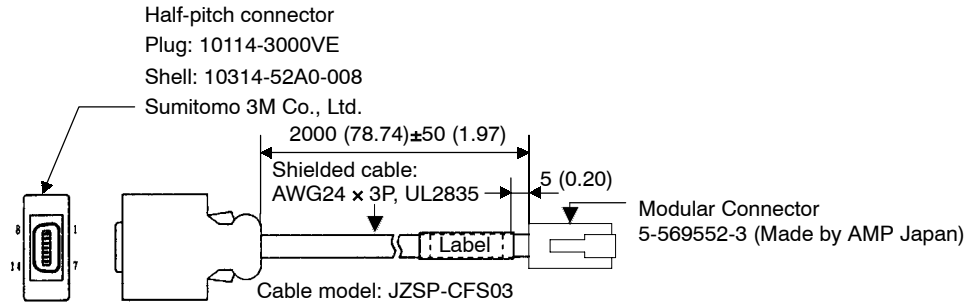

• **Connecting Circuit**

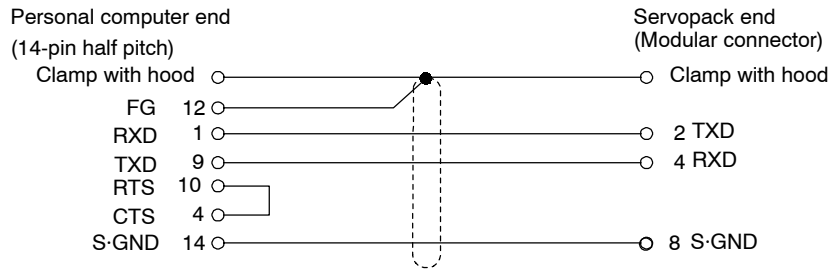

4

INSPECTION AND MAINTENANCE

5

This chapter describes the basic inspections and maintenance to be carried out by the customer. In addition, troubleshooting procedures are provided for problems which cause an alarm display and for problems which result in no alarm display.

5.1	Servo Drive Inspection and Maintenance	5-2
5.1.1	Servomotors	5-2
5.1.2	Servopack	5-3
5.2	Error Diagnosis and Troubleshooting	5-4
5.2.1	Troubleshooting Problems with Alarm Display	5-4
5.2.2	Troubleshooting Problems With No Alarm Display	5-13
5.2.3	Servopack Connection Diagrams	5-15

5.1 Servo Drive Inspection and Maintenance

This section describes the basic inspections and maintenance for Servomotors and Servopacks.

5.1.1 Servomotors

For inspection and maintenance of Servomotors, follow the simple, daily inspection procedures in the table below.

The Servomotors are brushless. Simple, daily inspection is sufficient. The inspection and maintenance frequencies in the table are only guidelines. Increase or decrease the frequency to suit the operating conditions and environment.

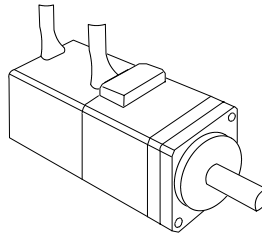

Item	Frequency	Procedure	Comments
Vibration and noise	Daily	Touch and listen.	Levels higher than normal?
Appearance	According to degree of contamination	Clean with cloth or compressed air.	---
Insulation resistance measurement	At least once a year	Disconnect Servopack and test insulation resistance at 500 V. Resistance is normal if it exceeds 10 M Ω . (See note below)	Contact your Yaskawa representative if the insulation resistance is below 10 M Ω .
Replace oil seal	At least once every 5,000 hours	Remove Servomotor from machine and replace oil seal.	Applies only to motors with oil seal.
Overhaul	At least once every 20,000 hours or 5 years	Contact your Yaskawa representative.	The customer should not disassemble and clean the Servomotor.

Note Measure across the Servomotor FG and the U-phase, V-phase, or W-phase power lead.

During inspection and maintenance, do not disassemble the Servomotor. If disassembly of the Servomotor is required, contact your Yaskawa representative.

5.1.2 Servopack

For inspection and maintenance of the Servopack, follow the inspection procedures in the following table at least once every year. Daily inspection of the Servopack is not required.

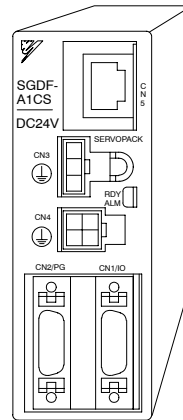

Item	Frequency	Procedure	Maintenance
Clean unit interior and circuit boards	At least once a year	Check for dust, dirt, and oil on the surfaces.	Clean with compressed air or cloth.
Loose screws	At least once a year	Check for loose terminal block and connector screws.	Tighten any loose screws.
Defective parts in unit or on circuit boards.	At least once a year	Check for discoloration, damage or discontinuities due to heating.	Contact your Yaskawa representative.

Part Replacement Schedule

The following parts are subject to mechanical wear or deterioration over time. To avoid failure, replace these parts at the frequency indicated.

Part	Standard Replacement Period	Replacement Method
Smoothing Capacitor	7 to 8 years	Test. Replace with new part if necessary.
Relays	---	Test. Replace if necessary.
Fuse	10 years	Replace with new part.
Aluminium electrolytic capacitor	5 years	Replace with new part if necessary.

Note Operating Conditions:

- Ambient Temperature: annual average 30°C
- Load Factor: 80% max.
- Operation Rate: 20 hours/day max.

5.2 Error Diagnosis and Troubleshooting

This section describes causes and remedies for problems which cause an alarm display and for problems which result in no alarm display.

5.2.1 Troubleshooting Problems with Alarm Display

Refer to the following tables to identify causes of Servo Drive problems that cause an alarm display at the Digital Operator (A.□□ or CPF□□) and take the remedy described. The display, A.99, does not indicate an alarm.

Contact your Yaskawa representative if the problem cannot be solved by the described procedures.

1. A.02

Display and Outputs

Digital Operator Display	Alarm Name	Alarm Output
A.02	Parameters breakdown	Output transistor is OFF (alarm state)

Status when Alarm Occurred

The letters A and B in the following diagram correspond to the letters in the table. The letters in bold type indicate the main causes of the display.



	Cause	Remedy
A	Power turned OFF during parameter write. Alarm occurred next power ON.	Replace Servopack.
B	Circuit board (1PWB) defective	Replace Servopack.

2. A.04

Display and Outputs

Digital Operator Display	Alarm Name	Alarm Output
A.04	Parameter setting error	Output transistor is OFF (alarm state)

Status when Alarm Occurred

	Cause	Remedy
A	An out-of-range parameter was previously set or loaded.	Reset all parameters in range. Otherwise, re-load correct parameters.
B	Circuit board (1PWB) defective	Replace Servopack.

3. A.10**Display and Outputs**

Digital Operator Display	Alarm Name	Alarm Output
A.10	Overcurrent	Output transistor is OFF (alarm state)

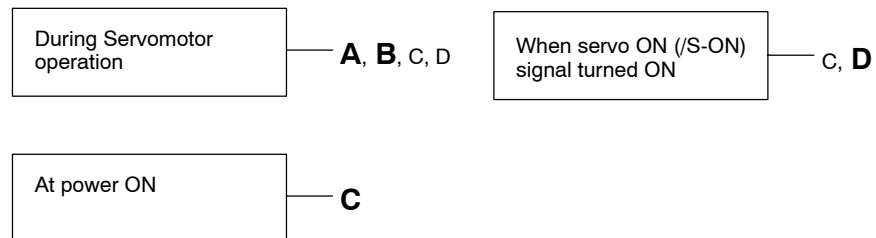
Status when Alarm Occurred

	Cause	Remedy
A	Wiring grounded between Servopack and Servomotor.	Check and correct wiring.
B	Servomotor phase-U, -V, or -W grounded.	Replace Servomotor.
C	<ul style="list-style-type: none"> • Circuit board (1PWB) defective • Power transistor defective 	Replace Servopack.
D	Current feedback circuit, power transistor, or circuit board defective.	Replace Servopack.

4. A.31**Display and Outputs**

Digital Operator Display	Alarm Name	Alarm Output
A.31	Position error pulse overflow (position control only)	Output transistor is OFF (alarm state)

Status when Alarm Occurred

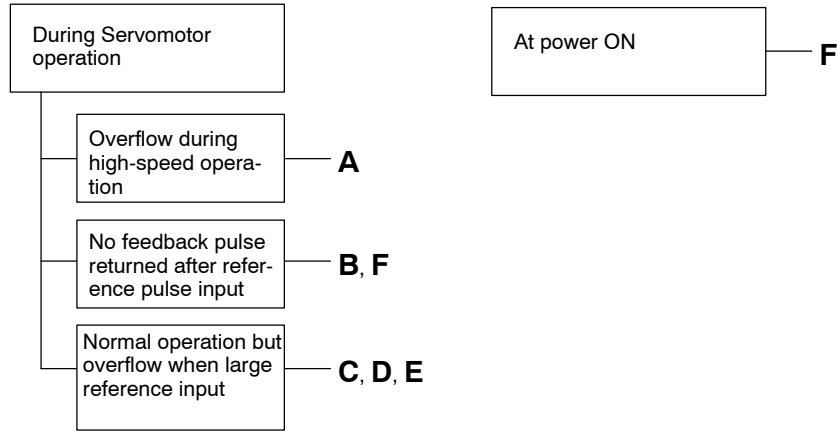

	Cause	Remedy
A	Servomotor wiring incorrect.	Check and correct wiring. (Check phase-A, -B, -C pulses correct at CN2.)
B	Encoder wiring incorrect (disconnection, short circuit, power supply, etc.)	
C	Servopack adjustment incorrect	Increase speed loop gain (Cn-04) and/or position loop gain (Cn-1A).
D	Servomotor overloaded	Reduce load torque and load moment of inertia. Otherwise, replace with larger capacity Servomotor.
E	Position reference pulse frequency too high	<ul style="list-style-type: none"> • Decrease reference pulse frequency. • Use smoothing function. • Change electronic gear ratio.
F	Circuit board (1PWB) defective.	Replace Servopack.

5. A.51

Display and Outputs

Digital Operator Display	Alarm Name	Alarm Output
A.51	Overspeed	Output transistor is OFF (alarm state)

Status when Alarm Occurred

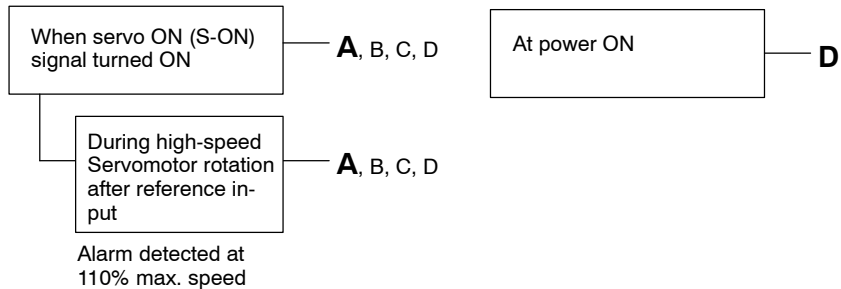

5

	Cause	Remedy
A	<ul style="list-style-type: none"> • Servomotor wiring incorrect. • Encoder wiring incorrect (disconnection, short circuit, power supply, etc.) 	Check and correct wiring. (Check phase-A, -B, -C pulses correct at CN2.)
B	Incremental encoder power not supplied from Servopack.	Use the Servopack power supply for the encoder.
C	Noise in encoder wiring.	Separate encoder wiring from main wiring circuits.
D	Circuit board (1PWB) defective	Replace Servopack.

6. A.70

Display and Outputs

Digital Operator Display	Alarm Name	Alarm Output
A.70	Overload	Output transistor is OFF (alarm state)

Status when Alarm Occurred

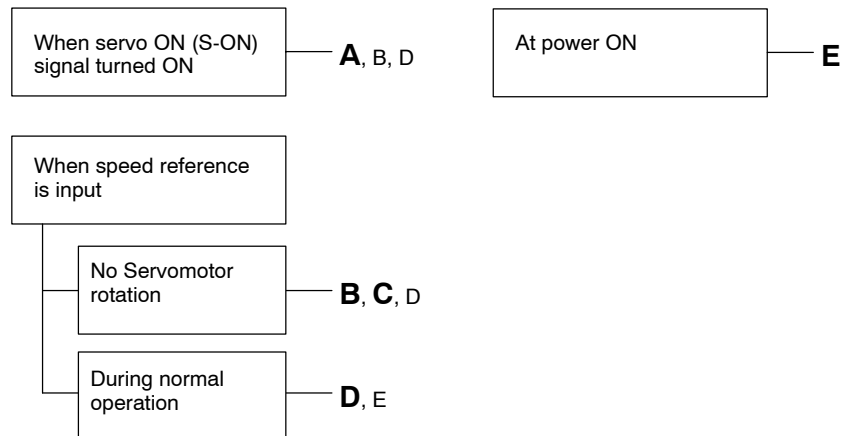

	Cause	Remedy
A	Servomotor wiring incorrect or disconnected	Check wiring and connectors at Servomotor.
B	Encoder wiring incorrect or disconnected	Check wiring and connectors at encoder.
C	Load greatly exceeds rated torque	Reduce load torque and load moment of inertia. Otherwise, replace with larger capacity Servomotor.
D	Incremental encoder power not supplied from Servopack.	Use the Servopack power supply for the encoder.
E	Circuit board (1PWB) defective	Replace Servopack.

7. A.80

Display and Outputs

Digital Operator Display	Alarm Name	Alarm Output
A.80	Encoder error	Output transistor is OFF (alarm state)

Status when Alarm Occurred

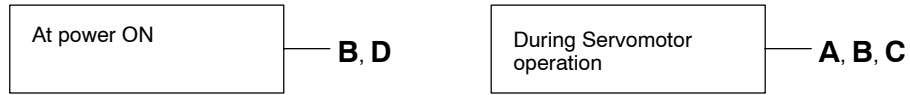

	Cause	Remedy
A	Servopack miscounted pulses or malfunctioned due to noise.	Separate encoder wiring from main wiring circuits turn ON Servopack power again.
B	Incorrect encoder wiring or poor connection.	Check the encoder wiring and connectors at encoder.
C	Encoder malfunctioned.	Replace Servopack.
D	Circuit board (1PWB) defective.	Replace Servopack.

8. A.b1

Display and Outputs

Digital Operator Display	Alarm Name	Alarm Output
A.b1	Reference input read error (for speed/torque control only)	Output transistor is OFF (alarm state)

Status when Alarm Occurred



	Cause	Remedy
A	Part malfunctioned in reference read-in unit (A/D converter, etc.).	Reset alarm and restart operation.
B	Part defective in reference read-in unit (A/D converter, etc.).	Replace Servopack.
C	Circuit board (1PWB) defective	Replace Servopack.

9. A.C1

Display and Outputs

Digital Operator Display	Alarm Name	Alarm Output
A.C1	Servo overrun	Output transistor is OFF (alarm state)

5

Status when Alarm Occurred

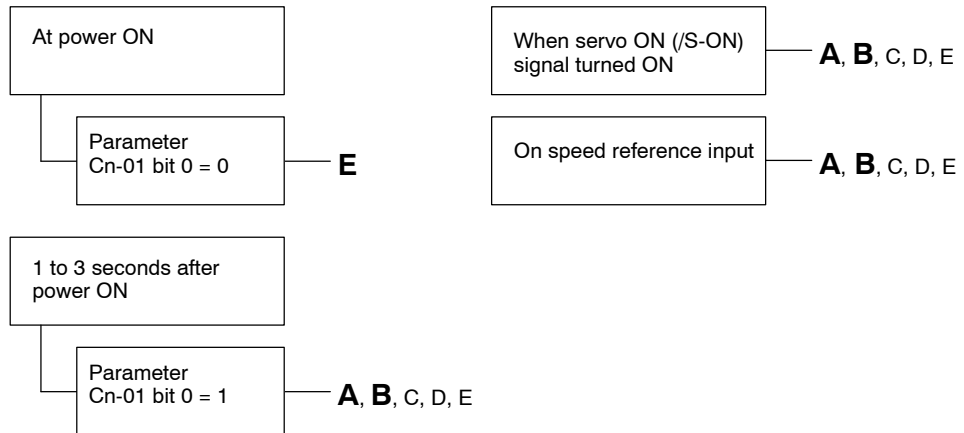

	Cause	Remedy
A	Servomotor wiring incorrect or disconnected.	Check wiring and connectors at Servomotor.
B	Encoder wiring incorrect or disconnected.	Check wiring and connectors at encoder.
C	Incremental encoder power not supplied from Servopack.	Use the Servopack power supply for the encoder.
D	Encoder defective.	Replace Servomotor.
E	Circuit board (1PWB) defective.	Replace Servopack.

5

10.A.C2

Display and Outputs

Digital Operator Display	Alarm Name	Alarm Output
A.C2	Encoder phase detection error	Output transistor is OFF (alarm state)

Status when Alarm Occurred

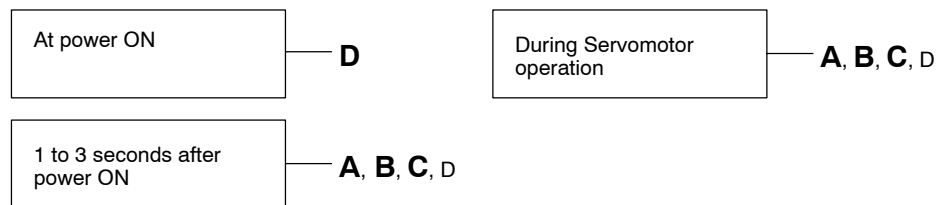

	Cause	Remedy
A	Noise in encoder wiring.	Separate encoder wiring from main wiring circuits.
B	Encoder wiring incorrect or poor connection.	Check wiring and connectors at encoder.
C	Encoder defective.	Replace Servomotor.
D	Circuit board (1PWB) defective.	Replace Servopack.

11.A.C3

Display and Outputs

Digital Operator Display	Alarm Name	Alarm Output
A.C3	Encoder phase-A, -B discontinuity	Output transistor is OFF (alarm state)

Status when Alarm Occurred

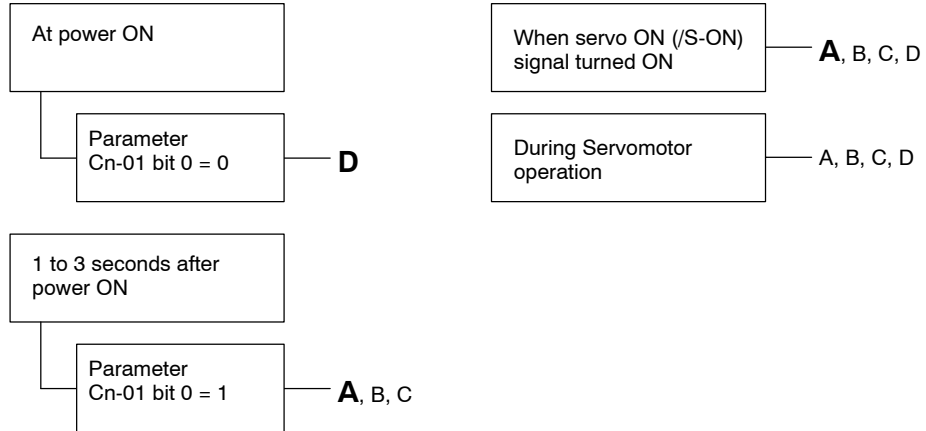

	Cause	Remedy
A	Encoder wiring incorrect or poor connection.	Check wiring and connectors at encoder.
B	Noise in encoder wiring.	Separate encoder wiring from main wiring circuits.
C	Encoder defective.	Replace Servomotor.
D	Circuit board (1PWB) defective.	Replace Servopack.

12.A.C4

Display and Outputs

Digital Operator Display	Alarm Name	Alarm Output
A.C4	Encoder phase-C discontinuity	Output transistor is OFF (alarm state)

Status when Alarm Occurred

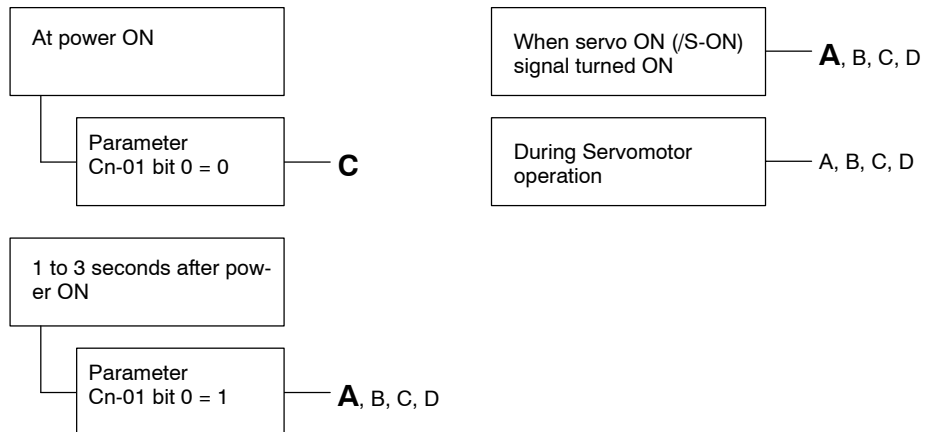

5

	Cause	Remedy
A	Encoder wiring incorrect or poor connection.	Check wiring and connectors at encoder.
B	Noise in encoder wiring.	Separate encoder wiring from main wiring circuits.
C	Encoder defective.	Replace Servomotor.
D	Circuit board (1PWB) defective.	Replace Servopack.

13.CPF00

Display and Outputs

Digital Operator Display	Alarm Name	Alarm Output
CPF00	Digital Operator transmission error 1	Not specified.

Note This alarm is not stored in alarm traceback function memory.

Status when Alarm Occurred

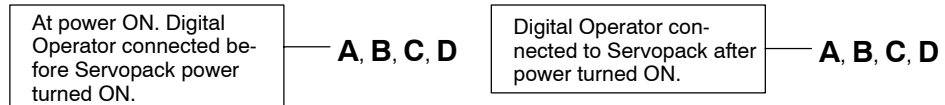

	Cause	Remedy
A	Cable defective or poor contact between Digital Operator and Servopack.	<ul style="list-style-type: none"> • Check connector connections. • Replace cable.
B	Malfunction due to external noise.	Separate Digital Operator and cable from noise source.
C	Digital Operator defective.	Replace Digital Operator.
D	Servopack defective.	Replace Servopack.

14.CPF01

Display and Outputs

Digital Operator Display	Alarm Name	Alarm Output
CPF01	Digital Operator transmission error 2	Not specified.

Note This alarm is not stored in alarm traceback function memory.

Status when Alarm Occurred

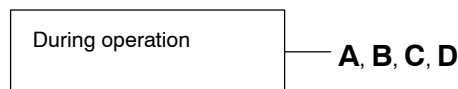

5.2.1 Troubleshooting Problems with Alarm Display

	Cause	Remedy
A	Cable defective or poor contact between Digital Operator and Servopack.	<ul style="list-style-type: none">• Check connector connections.• Replace cable.
B	Malfunction due to external noise.	Separate Digital Operator and cable from noise source.
C	Digital Operator defective.	Replace Digital Operator.
D	Servopack defective.	Replace Servopack.

15.A.99

Display and Outputs

Digital Operator Display	Alarm Name	Alarm Output
A.99	---	Output transistor is ON.

Status when Alarm Occurred

A.99 is not an alarm. The display A.99 indicates normal operation.

5.2.2 Troubleshooting Problems With No Alarm Display

Refer to the following table to identify the cause of a problem that causes no alarm display and take the remedy described.

Turn OFF the servo system power supply before commencing the procedures indicated with shading.

Contact your Yaskawa representative if the problem cannot be solved by the described procedures.

Symptom	Cause	Inspection	Remedy
Servomotor does not start	Power not connected	Check voltage across 24 VDC and GND.	Correct the power circuit.
	Loose connection	Check terminals of connectors (CN1, CN2).	Tighten any loose parts.
	Connector (CN1) external wiring incorrect	Check connector (CN1) external wiring	Refer to connection diagram and correct wiring.
	Servomotor or encoder wiring disconnected.		Reconnect wiring
	Overloaded	Run under no load.	Reduce load or replace with larger capacity Servomotor.
	Speed/position references not input	Check input pins.	Correctly input speed/position references.
	/S-ON is turned OFF	Cn-01 bit 0 is 0.	Turn /S-ON input ON.
	/P-CON input function setting incorrect	Check parameters Cn-01 bits A, B.	Refer to 2.2.1 <i>Speed References</i> and set parameters to match application.
	Reference pulse mode selection incorrect.	Refer to 2.2.2 <i>Position References</i> .	Select correct parameters Cn-02 bits 3, 4, 5.
/CLR input is turned ON	Check status of error counter clear input.	Turn /CLR input OFF.	
Servomotor moves instantaneously, then stops	Servomotor or encoder wiring incorrect.		Refer to 2.8 <i>Special Wiring</i> and correct wiring.
Suddenly stops during operation and will not restart	Alarm reset signal (/ALMRST) is turned ON because an alarm occurred.		Remove cause of alarm. Turn alarm reset signal (/ALMRST) from ON to OFF.
Servomotor speed unstable	Wiring connection to Servomotor defective	Check connection of power lead (phases U, V, and W) and encoder connectors.	Tighten any loose terminals or connectors.
Servomotor vibrates at approximately 200 to 400 Hz.	Speed loop gain value too high.		Reduce speed loop gain (Cn-04) preset value.
	Speed/position reference input lead too long.		Minimize length of speed/position reference input lead, with impedance not exceeding several hundred ohms
	Speed/position reference input lead is bundled with power cables.		Separate reference input lead at least 30 cm from power cables.
High rotation speed overshoot on starting and stopping.	Speed loop gain value too high.		Reduce speed loop gain (Cn-04) preset value.

INSPECTION AND MAINTENANCE

5.2.2 Troubleshooting Problems With No Alarm Display

Symptom	Cause	Inspection	Remedy
Servomotor overheated	Ambient temperature too high	Measure Servomotor ambient temperature.	Reduce ambient temperature to 40°C max.
	Servomotor surface dirty	Visual check	Clean dust and oil from motor surface.
	Overloaded	Run under no load.	Reduce load or replace with larger capacity Servomotor.
Abnormal noise	Mechanical mounting incorrect	Servomotor mounting screws loose?	Tighten mounting screws.
		Coupling not centered?	Center coupling.
		Coupling unbalanced?	Balance coupling.
	Bearing defective	Check noise and vibration near bearing.	Consult your Yaskawa representative if defective.
	Machine causing vibrations	Foreign object intrusion, damage or deformation of sliding parts of machine.	Consult with machine manufacturer.
Speed reference 0 V but Servomotor rotates.	Speed reference voltage offset applied	---	Refer to 3.2.4 <i>Reference Offset Automatic Adjustment Mode</i> and 3.2.5 <i>Reference Offset Manual Adjustment Mode</i> and adjust reference offset.

5.2.3 Servopack Connection Diagrams

This section provides Servopack internal connection diagram and instrument connection examples.

Refer to these diagrams during inspection and maintenance.

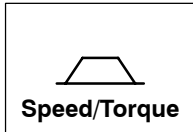

Internal Connection Diagram (for Speed/Torque Control)

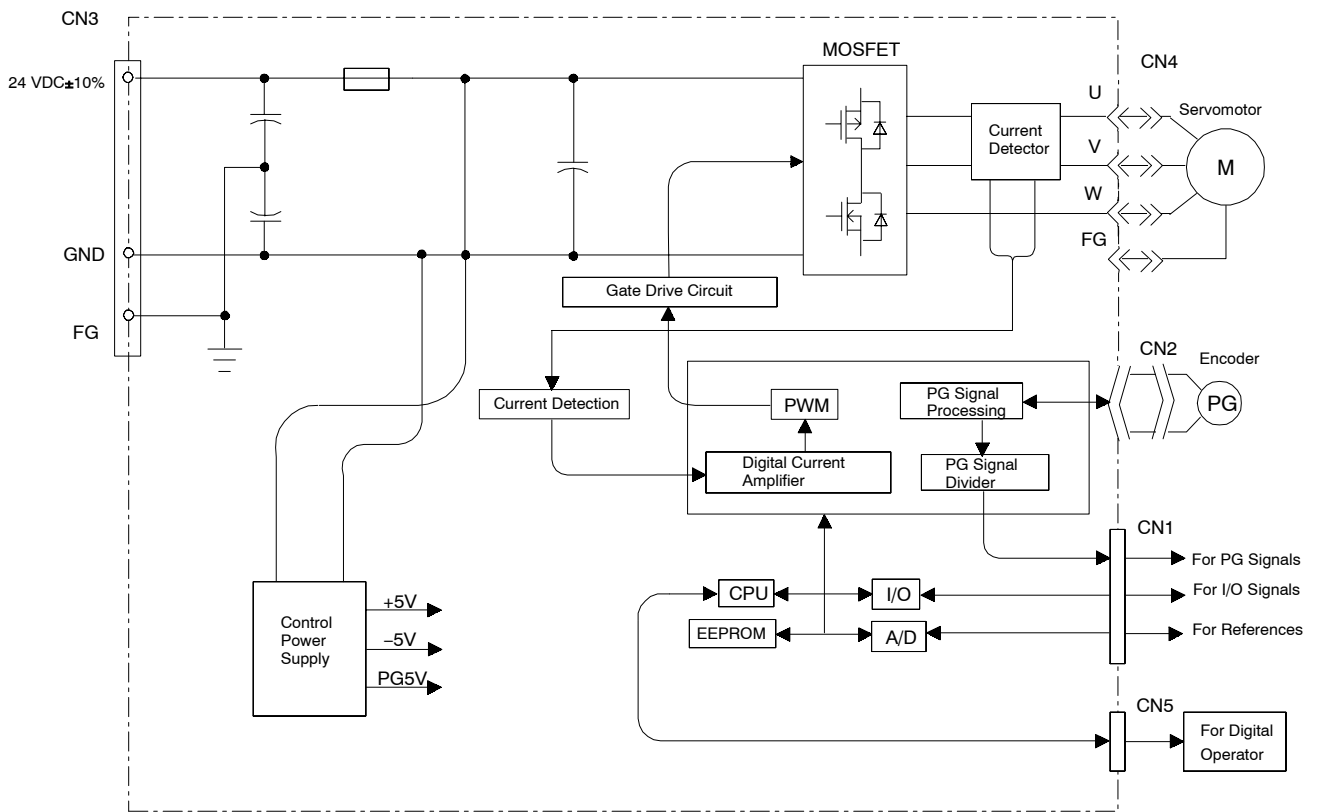

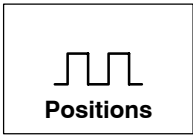

Internal Connection Diagram (for Position Control)

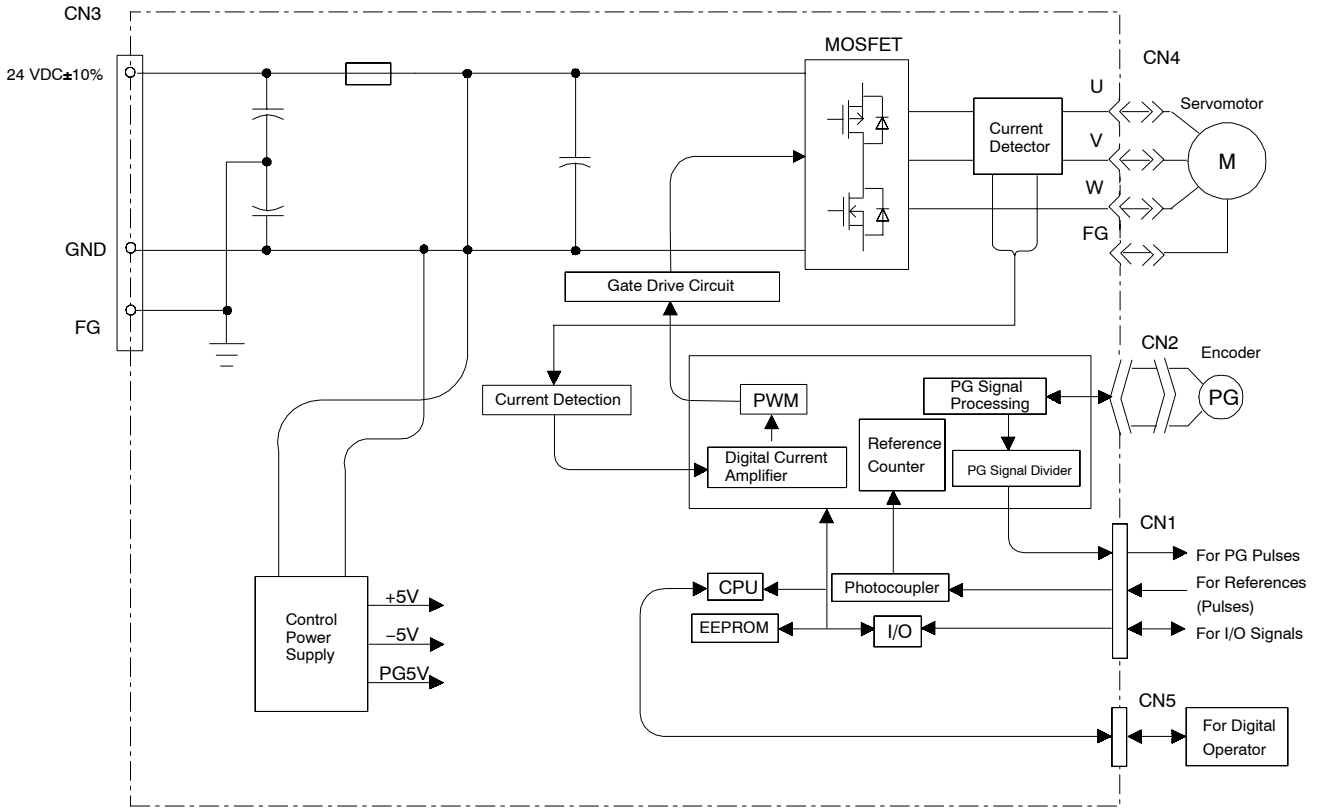

5

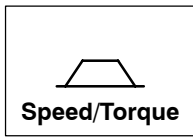

Instrument Connection Examples (for Speed/Torque Control)

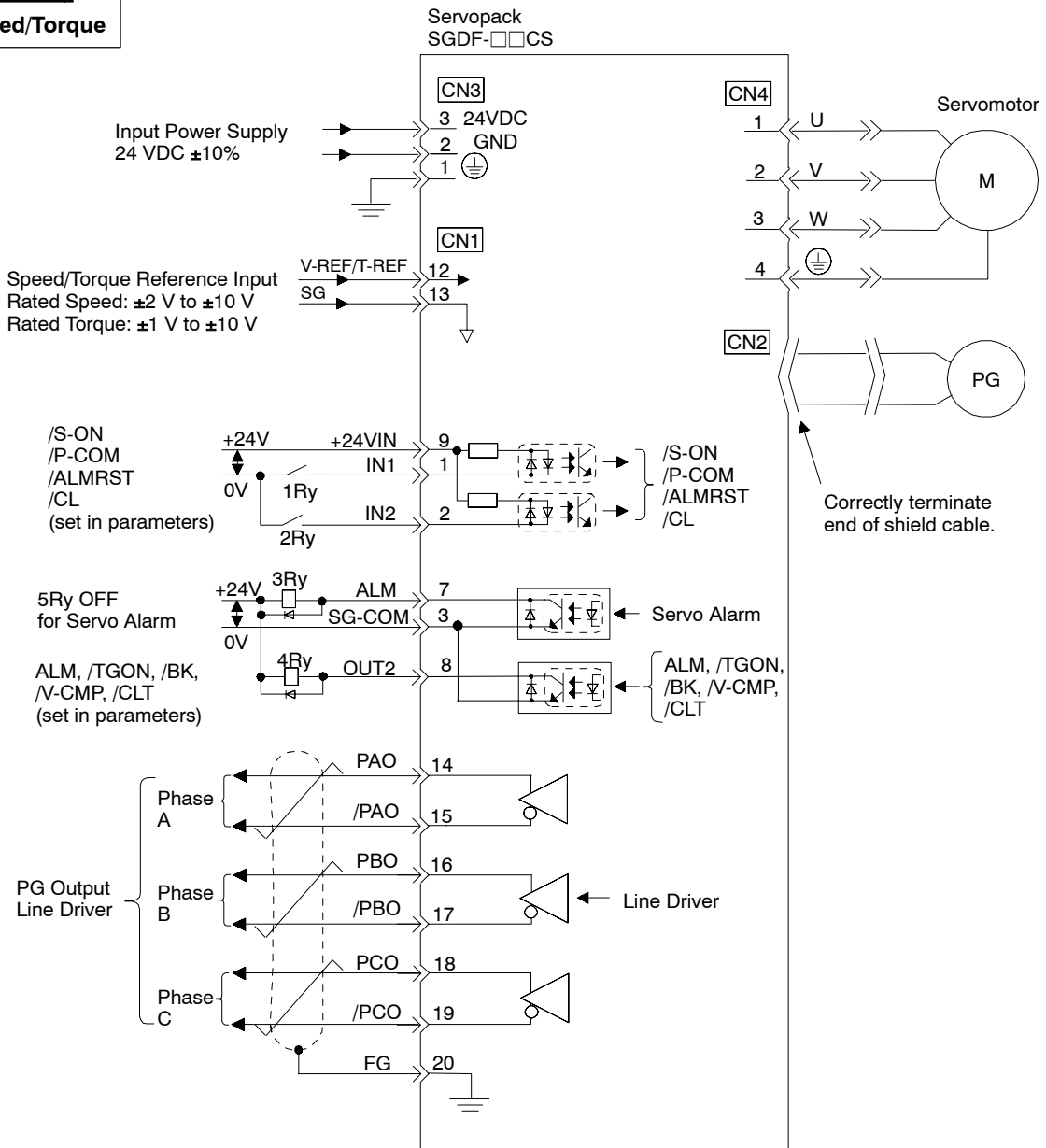

- Note 1:** The capacity of each output circuit is below 30 VDC and 50 mA.
Note 2: Signal input line ↓P represents twisted-pair cable.
Note 3: I/O power supply (+24 V) must be prepared by customers.

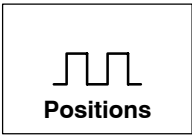

Instrument Connection Examples (for Position Control)

Positions

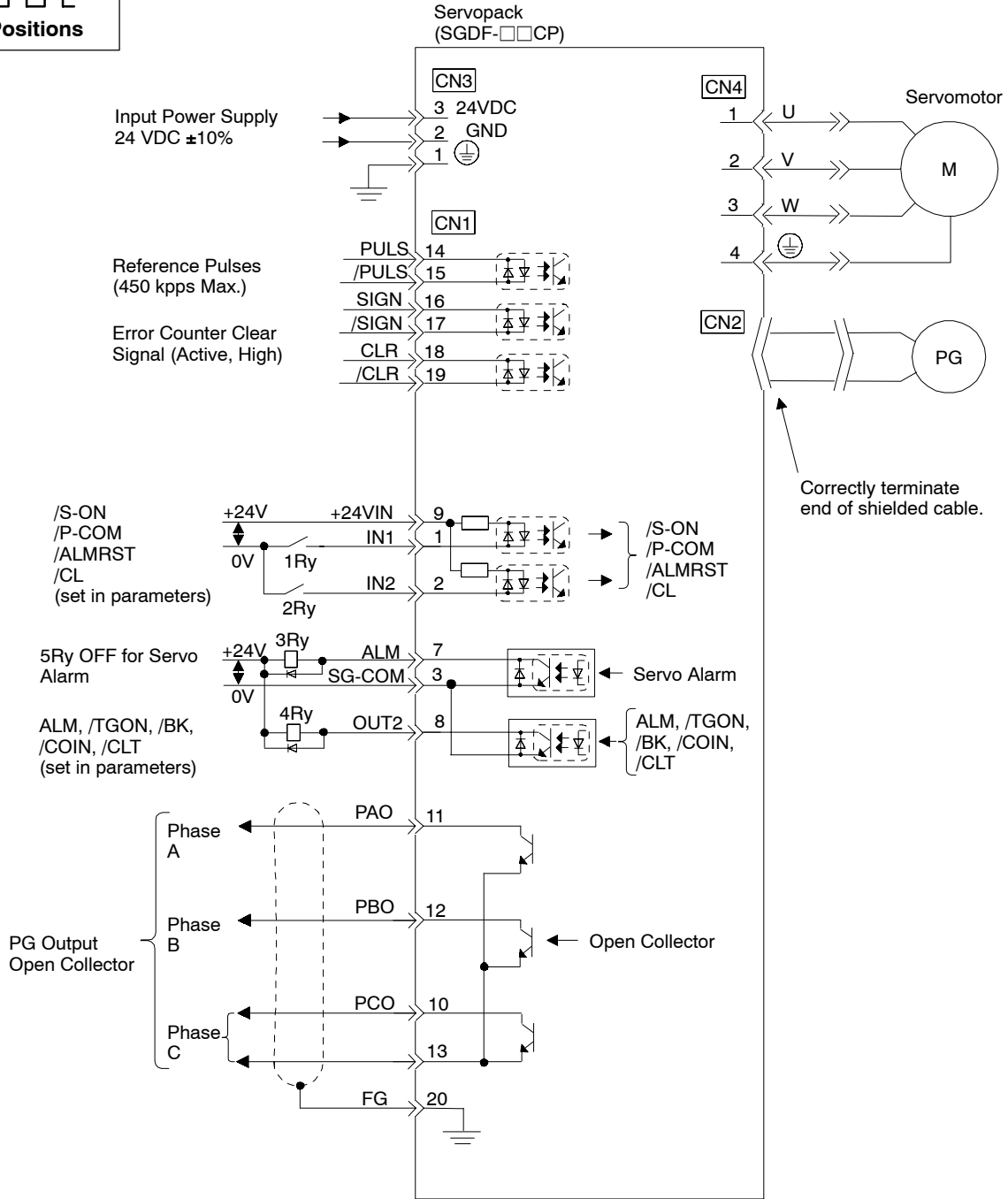

- Note 1:** The capacity of each output circuit is below 30 VDC and 50 mA.
- 2:** Signal input line †P represents twisted-pair cable.
- 3:** I/O power supply (+24 V) must be prepared by customers.

5

EMC DIRECTIVE MEASURES

6

This chapter describes the EMC Directives, which is one of the European safety standards applicable to Servopacks. In *6.2 Measures to Satisfy EMC Directives*, concrete measures are provided for the Servopack to conform to EN standards.

6.1	Servo Drive Inspection and Maintenance	6-2
6.1.1	What are EN Standards?	6-2
6.1.2	What is the CE Marking?	6-2
6.1.3	EMC Directive	6-2
6.1.4	TÜV Certification Body Authorized by EU	6-3
6.2	Measures to Satisfy the EMC Directive	6-4
6.2.1	Applicable Servomotors	6-4
6.2.2	Applicable Noise Filter	6-4
6.2.3	Applicable Power Supply	6-4
6.2.4	Motor Cables	6-4
6.2.5	Encoder Cables	6-5
6.2.6	Control I/O	6-7
6.2.7	Digital Operator and Monitoring by Personal Computer	6-7
6.2.8	Cable Core	6-7
6.2.9	Wiring Examples	6-8

6.1 Servo Drive Inspection and Maintenance

■ This section provides details on the EN Standards, CE marking, and EMC Directive.

6.1.1 What are EN Standards?

- 1) A board of directors consisting of EC cabinet members provided the EC Directives in 1985 when the European Union was called the EC. The purpose of the EC Directives was to manage products from all areas of Europe under one set of standards over the applicable standards of member countries.
- 2) The concrete standards for satisfying the EC Directives are the EN Standards (European standards). Currently, there are 12 different types of directives, such as the Machine Directive, the Low-voltage Directive, and the EMC Directive, that are specified as 12 standards.

6.1.2 What is the CE Marking?

- 1) The CE marking is a mark to indicate that a product is a safe product conforming to the protection level specified by the EC Directives. Attaching this mark to a machine indicates that the machine conforms to EN Standards based on the EC Directives. In Europe, every industrial machine must have a CE marking for the Machine Directive since January 1, 1995.
- 2) “CE” is an abbreviation of Communauté Européenne in French, which means European Communities (EC). Due to the increase of member countries, the name has been changed to EU (European Union), but EC is still used for the name of the directives.

6.1.3 EMC Directive

- 1) The EMC Directive is one of the EC Directives relating to safety requirements for industrial products. The EMC Directive is concerned with electromagnetic interference (magnetic noise) mainly from electronic devices. The two countermeasures specified are whether a product controls generating electromagnetic interference down to a level where it does not affect other devices (generating side) and whether any measures are provided to prevent an electronic device receiving electromagnetic interference from malfunctions (receiving side). If a product is considered to provide proper countermeasures for electromagnetic interference at both the generating side and the receiving side, the product is said to coexist with the electromagnetic environment, which means that the product satisfies EMC requirements.
- 2) EMC is an abbreviation of Electromagnetic Compatibility, indicating the electromagnetic compatibility of a product.

The following diagram illustrates the explanation provided in 1).

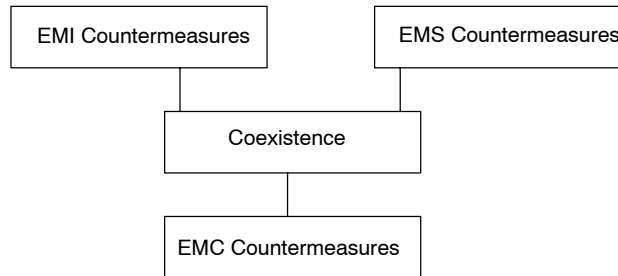

EMI: Electromagnetic Interference (generating side)

EMS: Electromagnetic Susceptibility (receiving side)

Machines are to be tested for EMC conformance according to their operating status.

6.1.4 TÜV Certification Body Authorized by EU

- 1) TÜV is one of the certification bodies authorized by the European Union (EU) specifying organization, which is the abbreviation of the “Technical Inspection Association” in German. TÜV has offices (TÜV Product Services, etc.) in Japan, through which Yaskawa obtains approvals. The Servopack has been approved by this TÜV.

6.2 Measures to Satisfy the EMC Directive

This section describes the measures required for Servopacks to conform to EMC Directive (EN55011, EN50082-2).

6.2.1 Applicable Servomotors

Use a Yaskawa Servomotor conforming to EN standards.

- Servomotor Models: SGMM-A1S312 (10 W)
SGMM-A2S312 (20 W)

Refer to 4.4.2 *Servomotor Dimensional Drawings: European Safety Standards* for details on the above Servomotors.

The difference with standard Servomotors is in the encoder connector only.

6.2.2 Applicable Noise Filter

Model	MYB-1206-33
Manufacturer	NEMIC-LAMBDA K.K

Make sure to ground the noise filter properly.

6.2.3 Applicable Power Supply

Use a power supply conforming to EN standards.

Make sure to ground the power supply properly.

Recommended power supply is as follows:

Model	PLEY24HSZ-PU
Manufacturer	ETA ELECTRIC IND. Co., Ltd

6.2.4 Motor Cables

The maximum cable length is 5 m (16.7 feet).

6.2.5 Encoder Cables

The maximum cable length is 5 m (16.7 feet). Select cables and connectors according to the following chart.

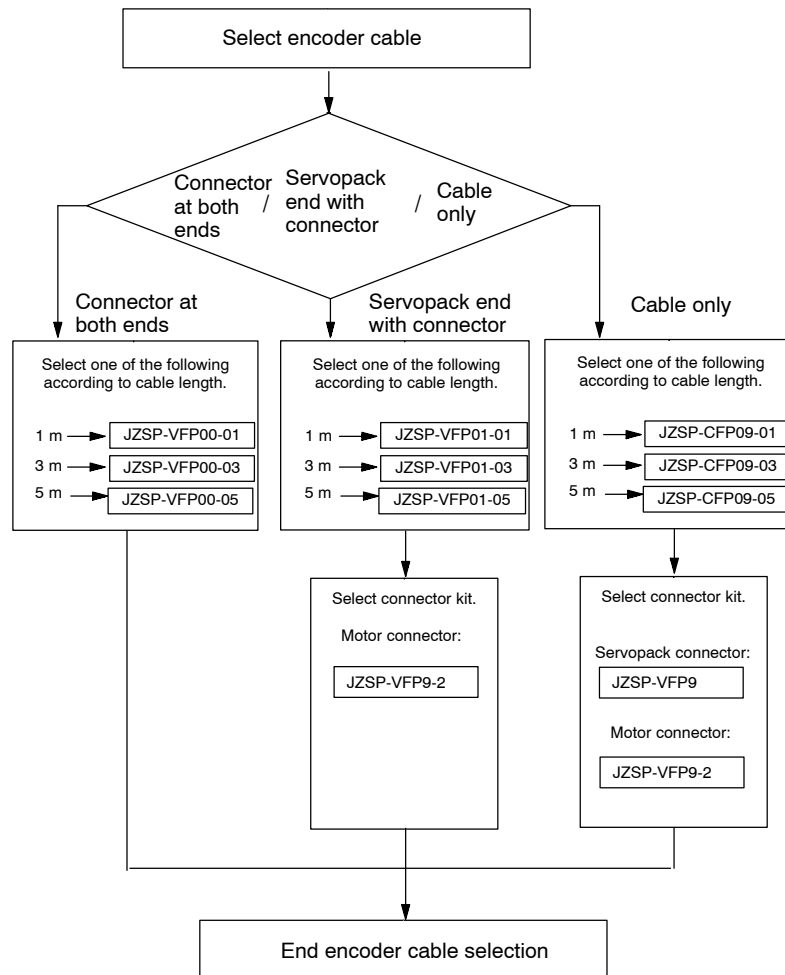

Encoder Cables: Connector at Both Ends

Model	L mm (feet)
JZSP-VFP00-01	1000 ⁺¹⁰⁰ ₀ (3.3 ^{+0.33} ₀)
JZSP-VFP00-03	3000 ⁺¹⁰⁰ ₀ (10 ^{+0.33} ₀)
JZSP-VFP00-05	5000 ⁺¹⁰⁰ ₀ (16.7 ^{+0.33} ₀)

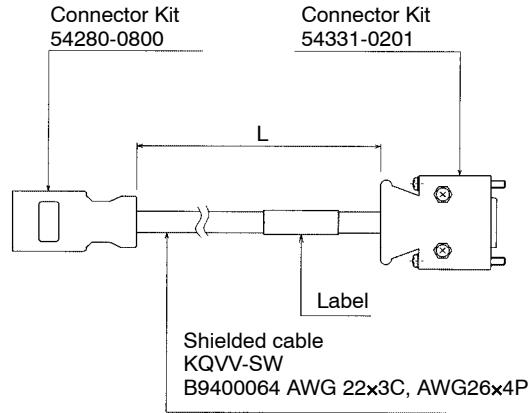

Encoder Connector Kit

- Motor Connector: JZSP-VFP9-2

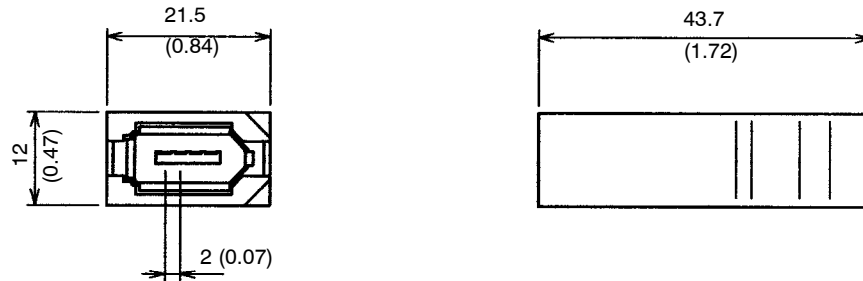

Socket Connector Kit: 54280-0800 (Product of Molex Japan)

Cable Connections

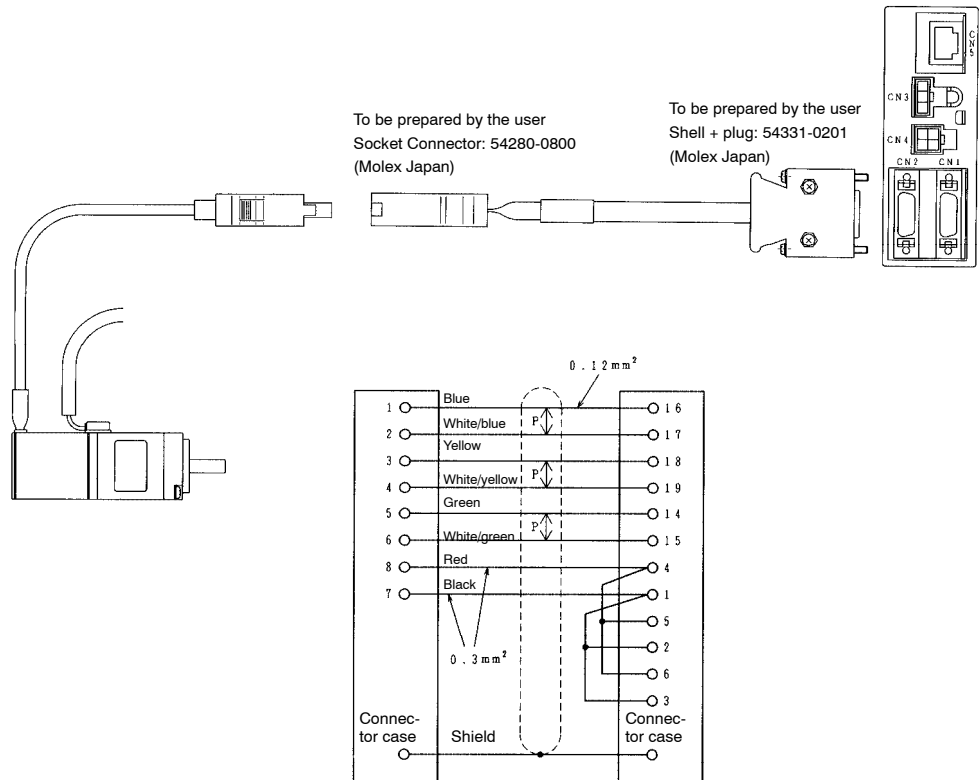

6.2.6 Control I/O

Use cables with CN1 connectors for control I/O. When using connector kits, use shielded cable for the CN1 cable and make sure to ground between the cable shield and connector case. Connect the shield at the host controller properly.

6.2.7 Digital Operator and Monitoring by Personal Computer

Use the Digital Operator or personal computer (for monitoring) for trial operation only. Disconnect them during normal operation.

6.2.8 Cable Core

Model	ESD-SR-25
Manufacturer	Token Corp.

The cable line and line position where the core is attached is as follows:

Cable Line	Encoder Line	Motor Line
Line Position	Servopack end Motor end	Servopack end

6.2.9 Wiring Examples

The following diagram shows the wiring conditions conforming to EMC Directive. The noise filter and the core are shown in the diagram.

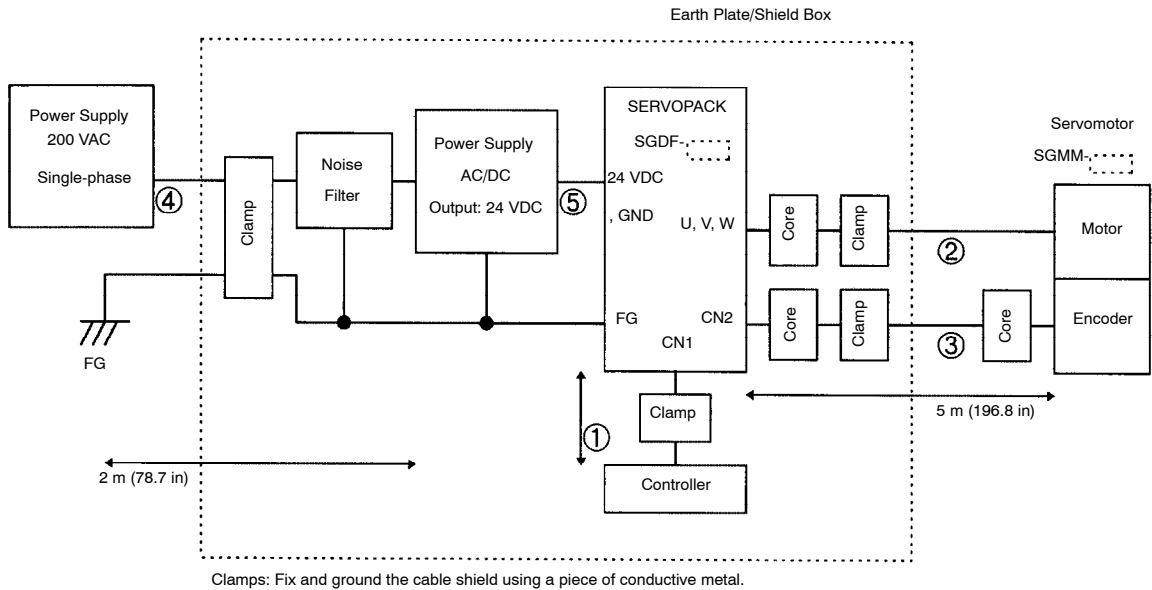

Symbol	Name	Specification
①	Controller cable	Shield cable (0.5 m)
②	Motor cable	Shield cable (5 m)
③	Encoder cable	Shield cable (5 m)
④	AC Line cable	Shield cable (2 m)
⑤	DC Line cable	Shield cable (0.5 m)

Appendix A

Servo Adjustment

A

This appendix provides the basic rules for Σ -Series AC Servopack gain adjustment, describes various adjustment techniques, and gives some preset values as guidelines.

A.1 Σ-Series AC Servopack Gain Adjustment	A-2
A.1.1 Σ -Series AC Servopacks and Gain Adjustment Methods	A-2
A.1.2 Basic Rules for Gain Adjustment	A-3
A.2 Adjusting a Speed-control Servopack	A-4
A.2.1 Adjusting Using Autotuning	A-4
A.2.2 Manual Adjustment	A-5
A.3 Adjusting a Position-control Servopack	A-8
A.3.1 Adjusting Using Autotuning	A-8
A.3.2 Manual Adjustment	A-9
A.4 Gain Setting References	A-13
A.4.1 Guidelines for Gain Settings According to Load Inertia Ratio	A-13

A.1 Σ -Series AC Servopack Gain Adjustment

This section provides some basic information required to adjust the servo system.

A.1.1 Σ -Series AC Servopacks and Gain Adjustment Methods

1) The main parameters changed by the customer to adjust the servo system include the following:

- Cn-04 (Speed Loop Gain)
- Cn-05 (Speed Loop Integration Time Constant)
- Cn-17 (Torque Reference Filter Time Constant)
- Cn-1A (Position Loop Gain)

In a Servopack for speed control (where speed references are applied as analog voltages), the position loop is controlled by the host controller, so the position loop gain is normally adjusted at the host controller.

If adjustment is not possible at the host controller, the same adjustment can be achieved using Cn-03 (Speed Reference Gain), but the Servomotor may not reach maximum speed for some preset values of this parameter.

A simple block diagram of the servo system is shown below.

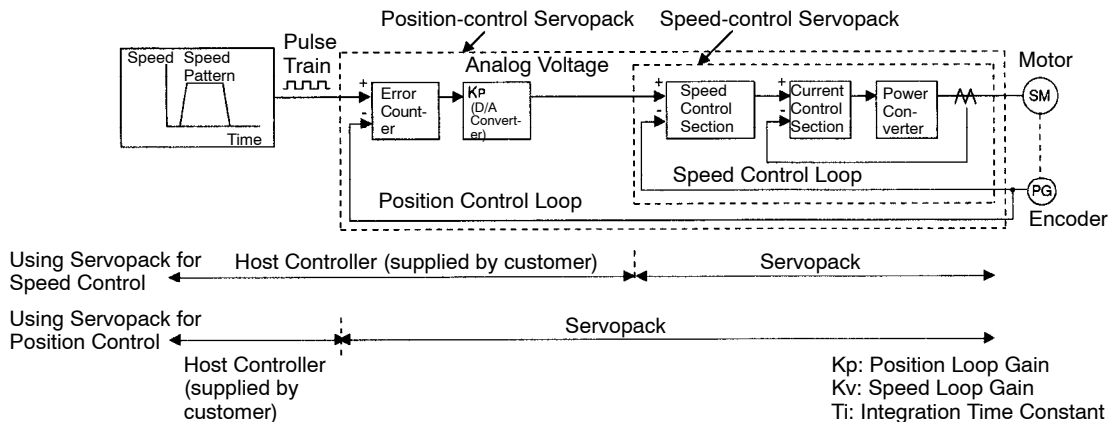

Note: A position-control Servopack has no D/A converter for speed reference output. This conversion is handled by internal calculations.

A.1.2 Basic Rules for Gain Adjustment

- 1) The servo system comprises three feedback systems: position loop, speed loop, and current loop. The response must increase from outer loop to inner loop (see the previous *Servo System Block Diagram*). The response deteriorates and oscillates if this principle is not obeyed.

The customer cannot adjust the current loop. Sufficient response is assured for the current loop.

The customer can adjust the position loop gain and speed loop gain, as well as the speed loop integration time constant and torque reference filter.

- 2) The position loop and speed loop must be adjusted to provide a balanced response. In particular, if the position loop gain only is increased (adjustment with Cn-03 at the Servopack if position loop gain adjustment is not possible at the host controller), the speed references oscillate and the result is increased, oscillating position control times.

If the position loop gain (or Cn-03) is increased, the speed loop gain (Cn-04) must be similarly increased.

If the mechanical system starts to oscillate after the position loop gain and speed loop gain are increased, do not increase the gains further.

- 3) The position loop gain should not normally be increased above the characteristic frequency of the mechanical system.

For example, the harmonic gears used in an articulated robot form a structure with extremely poor rigidity and a characteristic frequency of approximately 10 to 20 Hz. This type of machine allows a position loop gain of only 10 to 20 (1/s).

Conversely, the characteristic frequency of a precision machine tool such as a chip moulder or IC bonder exceeds 70 Hz, allowing a position loop gain exceeding 70 (1/s) for some machines.

Therefore, although the response of the servo system (controller, Servo Drive, motor, detectors, etc.) is an important factor where good response is required, it is also important to improve the rigidity of the mechanical system.

- 4) In cases where the position loop response is greater than or equal to the speed loop response and linear acceleration or deceleration is attempted, the poor speed loop response and follow-up cause an accumulation of position loop errors and result in increased output of speed references from the position loop.

The motor moves faster and overshoots as a result of increased speed references, and the position loop tends to decrease the speed references. However, the poor motor follow-up due to the poor speed loop response results in oscillating speed references, as shown in the diagram below.

If this problem occurs, reduce the position loop gain or increase the speed loop gain to eliminate the speed reference oscillations.

The following graph shows the speed reference output when the position loop gain and speed loop gain are unbalanced.

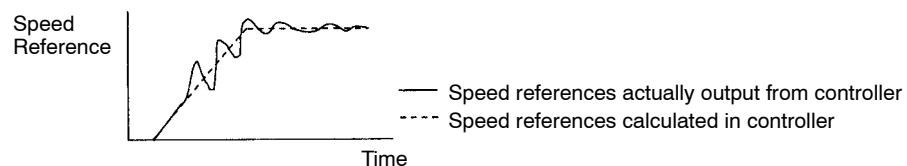

A.2 Adjusting a Speed-control Servopack

This section gives examples of adjusting the gains of a speed-control Servopack manually and using autotuning.

A.2.1 Adjusting Using Autotuning

Important Points about Autotuning

Speed During Autotuning

Autotuning may not function correctly if the speed is too low. Set the speed to approximately 500 min^{-1} .

Set the speed with the parameter Cn-10 (Jog Speed).

Machine Rigidity Selection

If the machine rigidity is unknown, select the rigidity according to the following standards.

Drive Method	Machine Rigidity
Ball screw, direct	3 (C-003) to 7 (C-007)
Ball screw, with reduction gears	2 (C-002) to 3 (C-003)
Timing belt	1 (C-001) to 3 (C-003)
Chain	1 (C-001) to 2 (C-002)
Wave decelerator (Harmonic Driver)	1 (C-001) to 2 (C-002)

Select the machine rigidity level according to the table.

Level	Rigidity
7 (C-007)	High
6 (C-006)	⋮
5 (C-005)	⋮
4 (C-004)	⋮
3 (C-003)	Medium
2 (C-002)	⋮
1 (C-001)	Low

Autotuning may not end if high response is selected for a low-rigidity machine or low response is selected for a high-rigidity machine.

If this occurs, halt the autotuning and change the machine rigidity selection.

If Autotuning is Unsuccessful

Autotuning may be unsuccessful (the end of autotuning not displayed) for machines with large play or extremely low rigidity.

Similarly, autotuning may be unsuccessful for a machine with high load moment of inertia (exceeding 15 to 30 times the motor moment of inertia).

In these cases, use conventional manual adjustment.

Even if autotuning is successful for a machine with large fluctuations in load rotor moment of inertia or load torque, vibrations or noise may still occur in some positions.

Response During Operation is Unsatisfactory after Autotuning

Autotuning sets the gain and integration time constant with some safety margin (to avoid oscillations). This can result in positioning times.

In particular, the target position may not be reached if low response is selected, because the machine does not move in response to the final minute references. An excessively high setting of the integration time constant (Cn-05) during autotuning is one cause of this problem.

If response is slow after autotuning, the speed loop gain cannot be manually increased very much before oscillation starts.

In this case, manually reduce the integration time constant while observing the machine behavior to ensure oscillation does not occur.

Autotuning does not set the torque reference filter (Cn-17) or speed reference gain (Cn-03).

A.2.2 Manual Adjustment

Applicable Parameters

The role of each parameter is briefly described below.

Speed Loop Gain (Cn-04)

This parameter sets the speed loop response.

The response is improved by setting this parameter to the maximum value in the range which does not cause vibrations in the mechanical system.

The following formula relates the speed loop gain to the load moment of inertia.

$$\text{Speed Loop Gain } K_v \text{ [Hz]} = \frac{2}{\frac{GD_L^2}{GD_M^2} + 1} \times (\text{Cn-04 Preset value})$$

GD_L^2 : Motor Axis Converted Load Moment of Inertia

GD_M^2 : Motor Moment of Inertia

Speed Loop Integration Time Constant (Cn-05)

The speed loop has an integration element to allow response to micro-inputs. This integration element can produce a delay in the servo system, and the positioning setting time increases and response becomes slower as the time constant increases. However, the integration time constant must be increased to prevent machine vibration if the load moment of inertia is large or the mechanical system includes a element that is prone to vibration.

The following formula calculates a guideline value.

$$T_i \geq 2.3 \times \frac{1}{2\pi \times K_v}$$

Ti: Integration Time Constant (s)

Kv: Speed Loop Gain (Hz)

Torque Reference Filter Time Constant (Cn-17)

When a ball screw is used, torsional resonance may occur which increases the pitch of the vibration noise.

This vibration can sometimes be overcome by increasing the torque reference filter time constant.

This filter will, however, produce a delay in the servo system, just like the integration time constant (Cn-05), and its value should not be increased more than necessary.

Speed Reference Gain (Cn-03)

Changing the speed reference gain (Cn-03) changes the position loop gain an equivalent amount. That is, reducing the speed reference gain is equivalent to reducing the position loop gain and increasing it is equivalent to increasing the position loop gain.

Use this parameter (Cn-03) in the following circumstances:

- No position loop gain adjustment at host controller (including cases where fine adjustment not possible by changing number of D/A converter bits)
- Clamping the speed reference output range to specific speeds

Normally leave at the factory setting.

Note For a speed-control Servopack, the position loop gain (Cn-1A) is valid in zero-clamp mode only.

For normal control, change the position loop gain at the host controller or adjust the speed reference gain (Cn-03) in the Servopack.

Changing Cn-1A does not change the position loop gain.

Adjustment Procedure

- 1) Set the position loop gain at the host controller to a low value and increase the speed loop gain (Cn-04) within the range that no abnormal noise or vibration occurs.
If adjustment of the position loop gain is not possible at the host controller, reduce the speed reference gain (Cn-03).
- 2) Slightly reduce the speed loop gain from the value at step 1, and increase the position loop gain at the host controller in the range that no overshooting or vibration occurs.
If adjustment of the position loop gain is not possible at the host controller, increase the speed reference gain (Cn-03).
- 3) Determine the speed loop integration time constant (Cn-05), by observing the positioning setting time and vibrations in the mechanical system.
The positioning setting time may become excessive if the speed loop integration time constant (Cn-05) is too large.
- 4) It is not necessary to change the torque reference filter time constant (Cn-17) unless torsional resonance occurs in the machine shafts.
Torsional resonance may be indicated by a high vibration noise. Adjust the torque reference filter time constant (Cn-17) to reduce the vibration noise.
- 5) Finally, fine adjustment of the position gain, speed gain, and integration time constant is required to determine the optimum point for step response.

A.3 Adjusting a Position-control Servopack

This section provides examples of adjusting the gains of a position-control Servopack manually and using autotuning.

A.3.1 Adjusting Using Autotuning

Autotuning

Speed During Autotuning

Autotuning may not function correctly if the speed is too low. Set the speed to approximately 500 min^{-1} .

Set the speed with the parameter Cn-10 (Jog Speed).

Machine Rigidity Selection

If the machine rigidity is unknown, select the rigidity according to the following standards.

Drive Method	Machine Rigidity
Ball screw, direct	3 (C-003) to 7 (C-007)
Ball screw, with reduction gears	2 (C-002) to 3 (C-003)
Timing belt	1 (C-001) to 3 (C-003)
Chain	1 (C-001) to 2 (C-002)
Wave decelerator (Harmonic Driver)	1 (C-001) to 2 (C-002)

Select the machine rigidity level according to the following table.

Level	Rigidity
7 (C-007)	High
6 (C-006)	:
5 (C-005)	:
4 (C-004)	:
3 (C-003)	Medium
2 (C-002)	:
1 (C-001)	Low

Autotuning may not end if high response is selected for a low-rigidity machine or low response is selected for a high-rigidity machine.

If this occurs, halt the autotuning and change the machine rigidity selection.

If Autotuning is Unsuccessful

Autotuning may be unsuccessful (the end of autotuning not displayed) for machines with large play or extremely low rigidity.

Similarly, autotuning may be unsuccessful for a machine with high load moment of inertia (exceeding 15 to 30 times the motor moment of inertia).

In these cases, use conventional manual adjustment.

Even if autotuning is successful for a machine with large fluctuations in load moment of inertia or load torque, vibrations or noise may still occur in some positions.

Response During Operation is Unsatisfactory after Autotuning

Autotuning sets the gain and integration time constant with some safety margin (to avoid oscillations). This can result in positioning times.

In particular, the target position may not be reached if low response is selected, because the machine does not move in response to the final minute references. An excessively high setting of the integration time constant (Cn-05) during autotuning is one cause of this problem.

If response is slow after autotuning, the speed loop gain cannot be manually increased very much before vibration starts.

In this case, manually reduce the integration time constant while observing the machine behavior to ensure oscillation does not occur.

Autotuning does not set the torque reference filter (Cn-17).

A.3.2 Manual Adjustment

Applicable Parameters

The role of each parameter is briefly described below.

Speed Loop Gain (Cn-04)

This parameter sets the speed loop response.

The response is improved by setting this parameter to the maximum value in the range which does not cause vibrations in the mechanical system.

The following formula relates the speed loop gain to the load moment of inertia.

$$\text{Speed Loop Gain } K_v \text{ [Hz]} = \frac{2}{\frac{GD_L^2}{GD_M^2} + 1} \times (\text{Cn-04 Preset value})$$

GD_L^2 : Motor Axis Converted Load Moment of Inertia

GD_M^2 : Motor Moment of Inertia

Speed Loop Integration Time Constant (Cn-05)

The speed loop has an integration element to allow response to micro-inputs. This integration element can produce a delay in the servo system, and the positioning setting time increases and response becomes slower as the time constant increases. However, the integration time constant must be increased to prevent machine vibration if the load moment of inertia is large or the mechanical system includes a vibration elements.

The following formula calculates a guideline value.

$$T_i \geq 2.3 \times \frac{1}{2\pi \times K_v}$$

T_i: Integration Time Constant (s)

K_v: Speed Loop Gain (Hz)

Torque Reference Filter Time Constant (Cn-17)

When a ball screw is used, torsional resonance may occur which increases the pitch of the vibration noise.

These vibrations can sometimes be overcome by increasing the torque reference filter time constant.

This filter will, however, produce a delay in the servo system, just like the integration time constant (Cn-05), and its value should not be increased more than necessary.

Position Loop Gain

The position loop gain parameter sets the servo system response.

The higher the position loop gain is set, the better the response and shorter the positioning times.

To enable a high setting of the position loop gain, increase the machine rigidity and raise the machine characteristic frequency.

Increasing the position loop gain only to improve the response can result in oscillating response of the overall servo system, that is, the speed references output from the position loop oscillate. Therefore, also increase the speed loop gain while observing the response.

Adjustment Procedure

- 1) Set the position loop gain to a low value and increase the speed loop gain (Cn-04) within the range so that no abnormal noise or oscillation occurs.
- 2) Slightly reduce the speed loop gain from the value at step 1, and increase the position loop gain in the range that no overshooting or oscillation occurs.
- 3) Determine the speed loop integration time constant (Cn-05), by observing the positioning set time and vibrations in the mechanical system.
The positioning set time may become excessive if the speed loop integration time constant is too large.

- 4) It is not necessary to change the torque reference filter time constant (Cn-17) unless torsional resonance occurs in the machine shafts.
Torsional resonance may be indicated by a high vibration noise. Adjust the torque reference filter time constant (Cn-17) to reduce the vibration noise.
- 5) Finally, fine adjustment of the position gain, speed gain, and integration time constant is required to determine the optimum point for step response, etc.

Functions to Improve Response

The mode switch, feed-forward, and bias functions improve response. However, they are not certain to improve response and may even worsen it in some cases. Follow the points outlined below and observe the actual response while making adjustments.

Mode Switch

The mode switch improves the transition characteristics when the torque references become saturated during acceleration or deceleration. Above the set level, the speed loop control switches from PI (proportional/integral) control to P (proportional) control.

Feed-forward Function

Use feed-forward to improve the response speed. However, feed-forward may be ineffective in systems where a sufficiently high value of position loop gain is not possible. Follow the procedure below to adjust the feed-forward amount (Cn-1D).

- a) Adjust the speed loop and position loop, as described above.
- b) Gradually increase the feed-forward amount (Cn-1D), such that the positioning complete (/COIN) signal is output early.

At this point, ensure that the positioning complete (/COIN) signal breaks up (alternately turns ON/OFF) and that the speed does not overshoot. These problems can arise if the feed-forward is set too high.

This filter can be used to correct breakup (alternately turning ON/OFF) of the positioning complete (/COIN) signal or speed overshoot arising when feed-forward is activated.

Bias Function

When the lag pulses in the error counter exceeds the positioning complete width (Cn-1B), the bias amount (Cn-1C) is added to the error counter output (speed reference). If the lag pulses in the error counter lies within the positioning complete width (Cn-1B), the bias amount (Cn-1C) is no longer added.

This reduces the number of pulses in the error counter and shortens the positioning time. The motor speed becomes unstable if the bias amount is too large.

Observe the response during adjustment as the optimum value depends on the load, gain, and positioning complete width.

Set Cn-0C to zero (0) when the bias is not used.

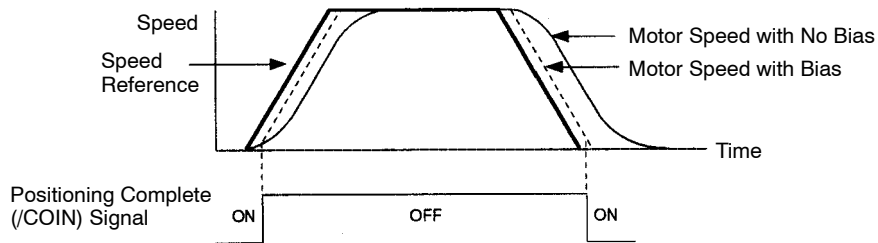

The adjustment procedures described above are common for all Yaskawa digital AC Servopacks. However, not all functions are available on each Servopack. Consult the technical specifications of your Servopack for details.

The adjustment procedures are also identical for conventional analog servos. However, in this case, the adjustments are made using potentiometers instead of the parameters.

A.4 Gain Setting References

This section presents tables of load moment of inertia values for reference when adjusting the gain.

A.4.1 Guidelines for Gain Settings According to Load Inertia Ratio

Adjustment guidelines are given below according to the rigidity of the mechanical system and load moment of inertia. Use these values as guidelines when adjusting according to the procedures described above.

These values are given as guidelines only. Oscillations and poor response may occur inside the specified value ranges. Observe the response (waveform) when optimizing the adjustment.

Higher gains are possible for machines with high rigidity.

Machines with High Rigidity

Ball Screw, Direct Drive Machines

Example: Chip moulder, IC bonder, precision machine tools

Load/Inertia Ratio (GD_L^2/GD_M^2)	Position Loop Gain (Cn-1A) [1/s]	Speed Loop Gain (Cn-04) [Hz]	Speed Loop Integration Time Constant (Cn-05) [ms]
1 x	50 to 70	50 to 70	5 to 20 Slightly increase for inertia ratio of 20 x, or greater.
3 x		100 to 140	
5 x		150 to 200	
10 x		270 to 380	
15 x		400 to 560	
20 x		500 to 730	
30 x		700 to 1100	

Note For an inertia ratio of 10 x, or greater, slightly reduce the position loop gain and speed loop gain below the values shown and set the integration time constant to a higher value before starting the adjustment.

As the inertia ratio increases, set the position loop gain and speed loop gain to the lower limit of the range of values specified. Conversely, increase the speed loop integration time constant.

Machines with Medium Rigidity

Machines driven by ball screw through reduction gears, or machines directly driven by long ball screws.

Example: General machine tools, orthogonal robots, conveyors

Load/Inertia Ratio (GD_L^2/GD_M^2)	Position Loop Gain (Cn-1A) [1/s]	Speed Loop Gain (Cn-04) [Hz]	Speed Loop Integration Time Constant (Cn-05) [ms]
1 x	30 to 50	30 to 50	10 to 40 Slightly increase for inertia ratio of 20 x, or greater.
3 x		60 to 100	
5 x		90 to 150	
10 x		160 to 270	
15 x		240 to 400	
20 x		310 to 520	
30 x		450 to 770	

Note For an inertia ratio of 10 x, or greater, slightly reduce the position loop gain and speed loop gain below the values shown and set the integration time constant to a higher value before starting the adjustment.

As the inertia ratio increases, set the position loop gain and speed loop gain to the lower limit of the range of values specified. Conversely, increase the speed loop integration time constant.

Machines with Low Rigidity

Machines driven by timing belts, chains or wave reduction gears (product name: Harmonic Drive).

Example: Conveyors, articulated robots

Load/Inertia Ratio (GD_L^2/GD_M^2)	Position Loop Gain (Cn-1A) [1/s]	Speed Loop Gain (Cn-04) [Hz]	Speed Loop Integration Time Constant (Cn-05) [ms]
1 x	10 to 20	10 to 20	50 to 120 Slightly increase for inertia ratio of 20 x, or greater.
3 x		20 to 40	
5 x		30 to 60	
10 x		50 to 110	
15 x		80 to 160	
20 x		100 to 210	
30 x		150 to 310	

Note For an inertia ratio of 10 x, or greater, slightly reduce the position loop gain and speed loop gain below the values shown and set the integration time constant to a higher value before starting the adjustment.

As the inertia ratio increases, set the position loop gain and speed loop gain to the lower limit of the range of values specified. Conversely, increase the speed loop integration time constant.

When a speed-control Servopack is used, set the position loop gain at the host controller. If the position loop gain cannot be set at the host controller, adjust the Servopack speed reference gain (Cn-03).

The position loop gain (Cn-1A) of a speed-control Servopack is valid in zero-clamp mode only.

The position loop gain is determined from the following relationship.

$$K_p = \frac{VS}{\epsilon}$$

K_p [1/s]: Position loop gain

VS [PPS]: Steady speed reference

ϵ : (pulse): Steady error

(The number of pulses in the error counter at steady speed.)

A

Appendix B

List of I/O Signals

This appendix lists I/O signal terminals (CN1 connector) on Servopacks which connect to a host controller or external circuit.

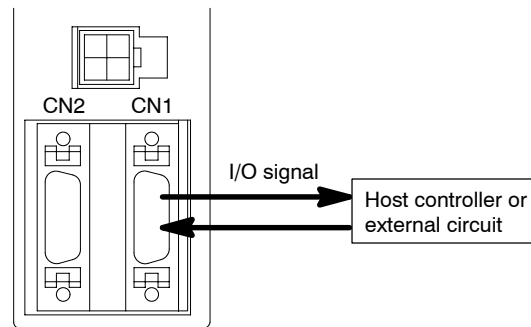

- Note**
- 1) The meanings of some signals for speed/torque control and position control are different. Always refer to the correct list for the Servopack type.
 - 2) Refer to *Chapter 2* for details of how to use I/O signals.
 - 3) The functions of I/O signal terminals differ according to the memory switch (Cn-01, Cn-02) settings.

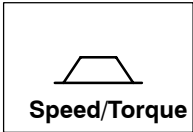

List of Input Signals for Speed/Torque Control

Spec-ifications	Standard Specifica-tions		Control Mode				I/O Signal	Zero-clamp		Contact Input Speed Control			
			Cn-01 Bit B = 0		Cn-01 Bit B = 1			Cn-01 Bit A = 1 Bit B = 0 Cn-2A or Cn-2B= 1		Cn-02 Bit 2 = 1		Cn-02 Bit 3, 4, 5 Rotation Direction	
1	IN1	Input signal 1					Input signal selection	/P-CON	Zero-clamp operation reference	IN1	Contact input speed selection		
2	IN2	Input signal 2					Input signal selection	/P-CON		IN2			
3	SG-COM	Signal ground common					Output signal selection						
4	---	Unused											
5	---	Unused											
6	---	Unused											
7	ALM	Alarm output											
8	OUT 2	Output signal 2											
9	+24V IN	24-V external power input											
10	---	Unused											
11	---	Unused											
12	V-REF/T-REF	Speed/torque reference input	V-REF	Speed reference input	T-REF	Torque reference input							
13	SG	Signal ground	SG	Signal ground	SG	Signal ground	---	Un-used	SG	Signal ground			
14	PAO	Phase A											
15	/PAO	Phase /A											
16	PBO	Phase B											
17	/PBO	Phase /B											
18	PCO	Phase C											
19	/PCO	Phase /C											
20	FG	Frame ground											

-
- Note**
- 1) Information described in the “Standard Specifications” column is also applicable to blank columns.
 - 2) Number “x.x.x” in box represents a section number corresponding to each signal name. For example, 2.2.1 represents section 2.2.1.



List of I/O Signals for Position Control

Specifications	Standard Specifications		I/O Signals	CCW Pulse + CW Pulse Reference		90° Different Two-phase Pulse Reference	
CN1 Terminal	Standard Setting		Cn-2A Cn-2B Cn-2C	Cn-02 Bits 5, 4, 3 = 0, 0, 1		Cn-02 Bits 5, 4, 3 = 0, 1, 0 (x 1 multiplication) = 0, 1, 1 (x 2 multiplication) = 1, 0, 0 (x 4 multiplication)	
1	IN1	Input signal 1	Input signal selection				
2	IN2	Input signal 2	Input signal selection				
3	SG-COM	Signal ground common					
4	---	Unused					
5	---	Unused					
6	---	Unused					
7	ALM	Alarm output					
8	OUT2	Output signal 2	Output signal selection				
9	+24VIN	24-V external power supply input					
10	PCO	Phase C	PG signal output				
11	PAO	Phase A					
12	PBO	Phase B					
13	SG	Signal ground					
14	PULS	Reference pulse input	PULS	Forward-run reference pulse input (CCW)	PULS	Phase-A reference pulse input	
15	/PULS		/PULS	Reverse-run reference pulse input (CW)	/PULS		
16	SIGN	Reference sign input	SIGN	Reverse-run reference pulse input (CW)	SIGN	Phase-B reference pulse input	
17	/SIGN		/SIGN		/SIGN		
18	CLR	Clear signal input					
19	/CLR						
20	FG	Frame ground					

Note 1) Information described in the “Standard Specifications” column is also applicable to blank columns.

2) Number “x.x.x” in box represents a section number corresponding to each signal name. For example, 2.2.1 represents section 2.2.1.

Appendix C

List of Parameters

- Servopacks provide many functions, and have parameters called “parameters” to allow the user to select each function and perform fine adjustment. This appendix lists these parameters.
- Parameters are divided into the following two types:

Memory switch Cn-01, Cn-02	Each bit of this switch is turned ON or OFF to select a function.
Parameter setting Cn-03 and later	A numerical value such as a torque limit value or speed loop gain is set in this constant.

Note Some parameters for speed/torque control and position control are different. Always refer to the correct list of parameters for the Servopack type.

Refer to *2.3.1 Setting Parameters* for details of how to use parameters.

For details of how to set parameters, refer to *3.1.5 Operation in Parameter Setting Mode*.

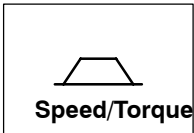

For Speed/Torque Control

List of Parameters (Parameter Setting)

Category	Parameter No.	Code	Name	Unit	Lower Limit	Upper Limit	Factory Setting	Remarks
-	Cn-00	Not a parameter. (Cn-00 is used to select special mode for digital operator.)						
	Cn-01	Memory switch (see page C-4) See note 1						
	Cn-02	Memory switch (see page C-4) See note 1						
Gain Related Constants	Cn-03	VREFGN	Speed reference adjustment gain	(min ⁻¹)/V	0	2162	500	
	Cn-04	LOOPHZ	Speed loop gain	Hz	1	2000	80	See note 2
	Cn-05	PITIME	Speed loop integration time constant	ms	2	10000	20	See note 2
	Cn-1A	POSGN	Position loop gain	1/s	1	500	40	See note 2 and 3
Torque Related Constants	Cn-13	TCRFGN	Torque reference gain	(0.1 V/100%)	10	100	30	
	Cn-08	TLMTF	Forward rotation torque limit	%	0	Maximum torque	Maximum torque	
	Cn-09	TLMTR	Reverse rotation torque limit	%	0	Maximum torque	Maximum torque	
	Cn-14	TCRLMT	Speed limit for torque control	min ⁻¹	0	Maximum speed	Maximum speed	
	Cn-17	TRQFIL	Torque reference filter time constant	0.1 ms	0	250	4	
	Cn-18	CLMI	Forward/reverse external torque limit	%	0	Maximum torque	100	
Sequence Related Constants	Cn-07	SFSACC	Soft start time (acceleration)	ms	0	10000	0	See note 4
	Cn-23	SFSDEC	Soft start time (deceleration)	ms	0	10000	0	See note 4
	Cn-0B	TGONLV	Zero-speed level	min ⁻¹	1		20	
	Cn-0F	ZCLVL	Zero-clamp level	min ⁻¹	0	16383	10	
	Cn-12	BRKTIM	Base block wait time	10 ms	0	50	0	
	Cn-15	BRKSPD	Brake wait speed	min ⁻¹	0	Maximum speed	100	
	Cn-16	BRKWAI	Brake wait time	10 ms	10	100	50	
	Cn-22	VCMPPLV	Speed coincidence signal output range	min ⁻¹	0	100	10	
Pulse Related Constants	Cn-0A	PGRAT	PG dividing ratio	P/R	16	32768	2048	See note 1
	Cn-11	PULSNO	Number of encoder pulses	P/R	513	32768	2048	See note 1

Category	Parameter No.	Code	Name	Unit	Lower Limit	Upper Limit	Factory Setting	Remarks
Other Constants	Cn-0C	TRQMSW	Mode switch (torque reference)	%	0	Maximum torque	200	
	Cn-0D	REFMSW	Mode switch (speed reference)	min ⁻¹	0	Maximum speed	0	
	Cn-0E	ACCMSW	Mode switch (acceleration reference)	10 (min ⁻¹)/s	0	3000	0	
	Cn-10	JOGSPD	Jog speed	min ⁻¹	0	Maximum speed	500	
	Cn-1F	SPEED1	1st speed (contact input speed control)	min ⁻¹	0	Maximum speed	100	
	Cn-20	SPEED2	2nd speed (contact input speed control)	min ⁻¹	0	Maximum speed	200	
	Cn-21	SPEED3	3rd speed (contact input speed control)	min ⁻¹	0	Maximum speed	300	
	Cn-28	NFBCC	Speed loop compensation constant	---	0	100	0	
	Cn-29	AXISNO	Axis address	---	0	14	0	
	Cn-2A	INS1	Input signal selection 1	---	0	3	0	See note 1
	Cn-2B	INS2	Input signal selection 2	---	0	3	2	See note 1
	Cn-2C	OUTS2	Output signal selection 2	---	0	4	3	See note 1

- Note**
- 1) After changing the setting, always turn OFF the power, then turn ON again to validate the new settings.
 - 2) Automatically set by autotuning function.
 - 3) Valid only when zero-clamp function is used.
 - 4) To use soft start function, always set both Cn-07 and Cn-23.

List of Parameters (Memory Switch Setting)

	Parameter No.	Bit No.	Setting		Factory Setting
			0	1	
Input signal enable/disable	Cn-01	0	Uses servo ON input.	Does not use servo ON input. Servo is always ON.	0
Not used		1, 2, 3, 4, 5, 6, 7, 8, 9	Not used (Do not set.)		0
Control mode selection		B-A	0-0: Speed control 0-1: Speed control with zero-clamp function 1-0: Torque control 1-1: Not used (Do not set.)		0-0
Mode switch selection		D-C	0-0: Uses internal torque reference as a condition. (Level setting: Cn-0C) 0-1: Uses speed reference as a condition. (Level setting: Cn-0D) 1-0: Uses acceleration as a condition. (Level setting: Cn-0E) 1-1: Does not use mode switch function.		0-0
Not used		E-F	Not used (Do not set.)		0
Rotation direction selection	Cn-02	0	Defines counterclockwise (CCW) rotation as forward rotation.	Defines clockwise (CW) rotation as forward rotation (reverse rotation mode).	0
Home position error processing selection		1	Detects home position error.	Does not detect home position error.	0
Contact input speed control		2	Does not use contact input speed control.	Uses contact input speed control.	0
Contact input speed control rotation direction selection		3	Contact input speed control Speed 1: Forward	Contact input speed control Speed 1: Reverse	0
		4	Contact input speed control Speed 2: Forward	Contact input speed control Speed 2: Reverse	0
		5	Contact input speed control Speed 3: Forward	Contact input speed control Speed 3: Reverse	0
Integration time constant setting unit		B	1 ms	0.01 ms	0
Torque reference filter type		C	Primary	Secondary	0
Not used	D, E, F	Not used (Do not set.)		0	

Note For the Cn-01 and Cn-02 memory switches, always turn OFF the power, then turn ON again to validate the new settings.

Input Signal Selection (Cn-2A, Cn-2B) Setting Values

Select the functions of input signals CN1-1 and CN1-2.

Setting Value	Function
0	/S-ON
1	/P-CON
2	/ALMRST
3	/CL

Output Signal Selection (Cn-2C) Setting Values

Select the functions of output signal CN1-8.

Setting Value	Function
0	ALM
1	/TGON
2	/BK
3	/V-CMP
4	/CLT

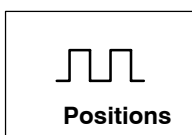

For Position Control

List of Parameters (Parameter Setting)

Category	Parameter No.	Code	Name	Unit	Lower Limit	Upper Limit	Factory Setting	Remarks	
	Cn-00		Not a parameter. (Cn-00 is used to select special mode for digital operator.)						
	Cn-01		Memory switch (see on page C-7)						See note 1
	Cn-02		Memory switch (see on page C-7)						See note 1
Gain Related Constants	Cn-04	LOOPH	Speed loop gain	Hz	1	2000	80	See note 2	
	Cn-05	PITIME	Speed loop integration time constant	ms	2	10000	20	See note 2	
	Cn-1A	POSGN	Position loop gain	1/s	1	500	40		
	Cn-1C	BIASLV	Bias	min ⁻¹	0	450	0		
	Cn-1D	FFGN	Feed-forward	%	0	100	0		
	Cn-26	ACCTME	Position reference acceleration/deceleration time constant	100 μs	0	640	0		
	Cn-27	FFFILT	Feed-forward reference filter	100 μs	0	640	0		
	Cn-08	TLMTF	Forward rotation torque limit	%	0	Maximum torque	Maximum torque		
	Cn-09	TLMTR	Reverse rotation torque limit	%	0	Maximum torque	Maximum torque		
	Cn-17	TRQFIL	Torque reference filter time constant	0.1 ms	0	250	4		
Cn-28	CLMI	Forward/reverse external torque limit	%	0	Maximum torque	100			
Sequence Related Constants	Cn-07	SFSACC	Soft start time (acceleration)	ms	0	10000	0	See note 4	
	Cn-23	SFSDEC	Soft start time (deceleration)	ms	0	10000	0	See note 4	
	Cn-0B	TGONLV	Zero-speed level	min ⁻¹	1		20		
	Cn-12	BRKTIM	Base block wait time	10 ms	0	50	0		
	Cn-15	BRKSPD	Brake wait speed	min ⁻¹	0	Maximum speed	100		
	Cn-16	BRKWAI	Brake wait time	10 ms	10	100	50		
	Cn-1B	COINLV	Positioning complete range	Reference unit	0	250	7		

LIST OF PARAMETERS

Category	Parameter No.	Code	Name	Unit	Lower Limit	Upper Limit	Factory Setting	Remarks
Pulse Related Constants	Cn-0A	PGRAT	PG dividing ratio	P/R	16	32768	2048	
	Cn-11	PULSNO	Number of encoder pulses	P/R	513	32768	2048	
	Cn-24	RATB	Electronic gear ratio (numerator)		1	65535	4	See note 3
	Cn-25	RATA	Electronic gear ratio (denominator)		1	65535	1	See note 3
Other Constants	Cn-0C	TRQMSW	Mode switch (torque reference)	%	0	Maximum torque	200	
	Cn-0D	REFMSW	Mode switch (speed reference)	min ⁻¹	0	Maximum speed	0	
	Cn-0E	ACCMSW	Mode switch (acceleration reference)	10 (min ⁻¹)/s	0	3000	0	
	Cn-0F	ERPMSW	Mode switch (error pulse)	Reference unit	0	10000	10	
	Cn-10	JOGSPD	Jog speed	min ⁻¹	0	Maximum speed	500	
	Cn-1E	OVRLV	Overflow	256 reference unit	1	32767	1024	
	Cn-28	NFBCC	Speed loop compensation constant	---	0	100	0	
	Cn-29	AXISNO	Axis address	---	0	14	0	
	Cn-2A	INS1	Input signal selection 1	---	0	3	0	See note 1
	Cn-2B	INS2	Input signal selection 2	---	0	3	2	See note 1
Cn-2C	OUTS2	Output signal selection 2	---	0	4	3	See note 1	

: Parameters that must always be set before turning ON power to the Servomotor.

Note 1) After changing the setting, always turn OFF the power, and then turn ON again to validate the new settings.

2) Automatically set by autotuning function.

3) The following restriction applies to electronic gear ratio (Cn-24 and Cn-25):

$$0.01 \leq \frac{B(Cn-24)}{A(Cn-25)} \leq 100$$

4) The soft-start function is valid during the jog operation or when the contact input speed control mode is selected. The function is invalid during pulse command operations.

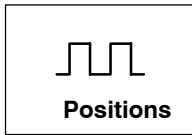

For Position Control

List of Parameters (Memory Switch Setting)

	Parameter No.	Bit No.	Setting		Factory Setting
			0	1	
Input signal enable/disable	Cn-01	0	Uses servo ON input.	Does not use servo ON input. Servo is always ON.	0
Not used		1, 2, 3, 4, 5, 6, 7, 8, 9	Not used (Do not set.)		0
Operation performed at servo OFF		A	Clears error pulse when servo is turned OFF.	Does not clear error pulse when servo is turned OFF.	0
Mode switch selection		B	Uses mode switch function as set in bits D and C of Cn-01.	Does not use mode switch function.	0
		D.C	0.0: Uses internal torque reference as a condition. (Level setting: Cn-0C) 0.1: Uses speed reference as a condition. (Level setting: Cn-0D) 1.0: Uses acceleration as a condition. (Level setting: Cn-0E) 1.1: Does not use mode switch function.		0.0
Not used		E	Not used (Do not set)		0
INHIBIT function			Always receives pulse reference.	Enables INHIBIT function.	0
Rotation direction selection		Cn-02	0	Defines counterclockwise (CCW) rotation as forward rotation.	Defines clockwise (CW) rotation as forward rotation (reverse rotation mode).
Home position error processing selection	1		Detects home position error.	Does not detect home position error.	0
Not used	2		Not used (Do not set)		0
Reference pulse form selection	5.4.3		0.0.0: Sign + Pulse 0.0.1: CW + CCW 0.1.0: Phase A + Phase B (x 1 multiplication) 0.1.1: Phase A + Phase B (x 2 multiplication) 1.0.0: Phase A + Phase B (x 4 multiplication)		0.0.0
Not used	6, 7, 8		Not used (Do not set)		0
Error counter clear signal	A		Clears the error counter when an error counter clear signal is at high level.	Clears the error counter when the leading edge of an error counter clear signal rises.	0
Integration time constant setting unit	B		1 ms	0.01 ms	0
Torque reference filter	C		Primary	Secondary	0
Reference pulse logic	D		Does not invert reference pulse logic.	Inverts reference pulse logic.	
Others	E		Displays position error Un-08 in x 1 reference units while in monitor mode.	Displays position error Un-08 in x 100 reference units while in monitor mode.	0
	F	Line driver (Maximum reference pulse frequency: 450 kpps)	Open collector (Maximum reference pulse frequency: 200 kpps)	0	

Note For the Cn-01 and Cn-02 memory switches, always turn OFF the power, and then turn ON again to validate the new settings.

Input Signal Selection (Cn-2A, Cn-2B) Setting Values

Select the functions of input signals CN1-1 and CN1-2.

Setting Value	Function
0	/S-ON
1	/P-CON
2	/ALMRST
3	/CL

Output Signal Selection (Cn-2C) Setting Values

Select the functions of output signal CN1-8.

Setting Value	Function
0	ALM
1	/TGON
2	/BK
3	/COIN
4	/CLT

C

Appendix D

List of Alarm Displays

- The Servopack allows up to 10 previous alarms to be displayed at a Digital Operator. This function is called a traceback function.

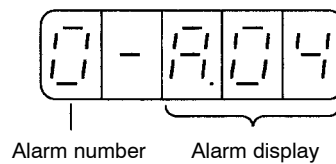

- This appendix provides the name and meaning of each alarm display.
- For details of how to display an alarm, refer to the following section:
3.2.1 Operation in Alarm Traceback Mode
- For details on causes of each alarm and the actions to be taken, refer to the following section:
5.2.1 Troubleshooting Problems with Alarm Display

Alarm Display

Alarm Display on Digital Operator	Alarm Output	Alarm Name	Meaning	Remarks
A.02	OFF	Parameter breakdown	Checksum results of parameters are abnormal.	
A.04	OFF	Parameter setting error	The parameter setting is outside the allowable setting range.	
A.10	OFF	Overcurrent	An overcurrent flowed through the power transistor.	
A.31	OFF	Position error pulse overflow	Position error pulse has exceeded the value set in parameter Cn-1E (overflow).	For the speed/torque control (only with the zero-clamp function), and for the position control
A.51	OFF	Overspeed	Motor speed has exceeded 4950 min ⁻¹ .	
A.70	OFF	Overload	Rated torque was exceeded during continuous operation.	
A.80	OFF	Encoder error	The number of encoder feedback pulses is abnormal.	
A.b1	OFF	Reference input read error	Servopack CPU failed to detect reference input.	For speed/torque control
A.C1	OFF	Servo overrun detected	The Servomotor (encoder) ran out of control.	
A.C2	OFF	Encoder output phase error	Phase-A, -B and -C output by the encoder are abnormal.	
A.C3	OFF	Encoder phase-A, -B disconnection	Wiring in encoder phase A or B is disconnected.	
A.C4	OFF	Encoder phase-C disconnection	Wiring in encoder phase C is disconnected.	
CPF00	Undefined	Digital Operator transmission error 1	Digital Operator fails to communicate with Servopack even five seconds after power is turned ON.	These alarms are not stored in alarm traceback memory.
CPF01	Undefined	Digital Operator transmission error 2	Transmission error has occurred five consecutive times.	
A.99	ON	Not an error	Normal operation status	

OFF: Output transistor is OFF (alarm state)
 ON: Output transistor is ON



Checksum

An automatic check function for a set of data such as parameters. It stores the sum of parameter data, recalculates the sum at specific timing, and then checks whether the stored value matches the recalculated value. This function is a simple method of checking whether a set of data is correct.

INDEX

A

- alarm, display, list, D-2
- alarm code output, 2-60
- alarm output signals, wiring, 2-60
- alarm traceback data, clearing, 3-25
- alarm traceback mode, 3-13
- alarms
 - display, troubleshooting, 5-4
 - Servo, resetting using Digital Operator, 3-3
 - servo, reset, 3-3
- alignment, 1-7
 - radial load, 1-8
 - thrust load, 1-8
- autotuning, 3-18
 - adjustment of position control Servopacks, A-8
 - adjustment of speed-control Servopacks, A-4
 - precautions, 3-19

B

- bits, turning ON and OFF, 3-8
- brake control relay, 2-43

C

- cables
 - 14-pin half-pitch connector, 4-70
 - D-sub, 24-pin connector, 4-67
 - D-sub, 9-pin connector, 4-69
- encoders
 - dimensional drawings, 4-54
 - specifications, 4-54
- for connecting personal computers, 4-69
- motor
 - dimensional drawings, 4-51
 - specifications, 4-51
 - specifications, 4-50
- communications specifications, 4-68
- connections
 - contact input signal terminals, 2-21
 - contact output signal terminals, 2-22
 - I/O signal terminals, Servopack, 1-16
- connectors
 - 1CN, test run, 1-24

- Digital Operator, 2-80
- incremental encoder, 2-76
- standard-type motor, 2-78
- terminal layouts, 2-74
 - Servopack position control, 2-75
 - Servopack speed/torque control, 2-74
- contact input signal terminals, connections, 2-21
- contact input speed control function, 2-28
 - motor speeds, 2-29
 - soft start time, 2-30
- contact output signal terminals, connections, 2-22

D

- Digital Operators
 - alarm traceback mode, 3-13
 - connection, 3-2
 - dimensional drawings, 4-46
 - mode selection, 3-4
 - monitor mode, 3-9
 - status display mode, 3-5
 - user constant setting mode, 3-7
 - motor operation, 3-15
 - servo alarm reset, 3-3
 - test run, 1-24
- dimensional diagrams, noise filter, 4-62
- dimensional drawings, 4-28, 4-37
 - cables, encoders, 4-54
 - Digital Operators, 4-46
 - Encoder Signal Converter Unit, 4-65
 - magnetic contactor, 4-62
 - motor cables, 4-51
 - Servomotors, 4-28-4-71
 - Servopacks, 4-45
 - variable resistors, 4-64
- dividing, 2-17

E

- electronic gear function, 2-24
 - setting, 2-24
- electronic gear ratio, 2-24
 - for different load mechanisms, 2-27
 - load travel distance per revolution of load shaft in reference units, 2-25
 - machine specifications, 2-24
 - number of encoder pulses for the SGM Servomotor, 2-24

- reference unit, 2-25
- encoder output, 2-17
 - signals, divided, 2-17
- Encoder Signal Converter Unit
 - dimensional drawings, 4-65
 - specifications, 4-65
- encoders, cables
 - dimensional drawings, 4-54
 - specifications, 4-54
- error counter, clearing, 2-16
- external torque limit, 2-6
- external torque limit input, 2-7
 - forward, 2-7
 - reverse, 2-7

F

- feed-forward control, 2-51
- fuse, 2-68

G

- gain
 - adjustment, 2-47, 2-49
 - AC Servopack, A-2
 - setting references, load inertia ratio, A-13
- grounding, 1-3
 - wiring, 2-70

H

- holding brake, 2-43
- hot start, 4-25

I

- I/O signal terminals, list
 - position control, B-4
 - speed/torque control, B-2
- impact resistance, 4-17
- INHIBIT function. *See* reference pulse inhibit function
- input pulse multiply function, 2-15
- input signal terminals
 - alarm reset, 2-61
 - error counter clear input, 2-16
 - forward external torque limit input, 2-7

- I/O power supply, 2-21
- proportional/integral control, 2-12
- reference pulse input, 2-14
- reference sign input, 2-14
- reverse external torque limit input, 2-7
- servo ON, 2-62
- signal ground for speed reference input, 2-9, 2-34
- signal ground for torque reference input, 2-34
- speed reference input, 2-9, 2-34
- speed selection, 2-31
- torque reference input, 2-34
- zero-clamp speed control, 2-41

- inspection, 5-2, 5-3
 - Servomotors, 5-2
 - Servopacks, 5-3
- installation, 1-4
 - servomotor, alignment, 1-7
 - Servomotors, 1-6
 - Servopacks, 1-9
- internal torque limit, 2-5

J

- jog speed, 2-39

L

- load inertia, gain settings, A-13
- loads
 - allowable radial load, 4-16
 - allowable thrust load, 4-16

M

- machine data table, 4-7
- machine rigidity, 3-17
 - selection, 3-19
- magnetic contactor, 1-13
 - dimensional drawings, 4-62
 - specifications, 4-62
- maintenance, 5-2, 5-3
 - Servomotors, 5-2
 - Servopacks, 5-3
- MCCB, 1-13, 2-68, 4-61
- mechanical tolerance, 4-16
- mode selection, Digital Operators, 3-4
- mode switch, 2-53
 - detection points
 - error pulse, 2-56

- motor acceleration, 2-55
- speed reference, 2-55
- torque reference, 2-54

molded-case circuit breaker. *See* MCCB

monitor mode, 3-9

motor

- operation, Digital Operators, 3-15
- type check, 3-26

N

noise control, 1-3

- filter, 1-13

- dimensional diagrams, 4-62

- installation, 2-70

- specifications, 4-62

- wiring, 2-69

O

output phase, form, 2-20

- absolute encoder, 2-20

- incremental encoder, 2-20

output signal terminals

- brake interlock output, 2-43

- encoder output, 2-18, 2-19

- frame ground, 2-20

- output signal ground common, 2-22, 2-44

- positioning complete output, 2-63

- running output, 2-65

- servo alarm output, 2-60

- signal ground for encoder output, 2-20

- signal ground for servo alarm output, 2-60

- speed coincidence output, 2-64

- torque limit output, 2-6

overhanging load

- precautions, 1-3

- Servomotors, 4-26

overload, characteristics, Servopacks, 4-25

P

parameters

- dividing ratio setting, 2-20

- dividing ratio settings, 2-19

- zero-clamp level, 2-42

peripheral devices

- selection, 4-47

- flowchart, 4-48

- specifications, 4-50

- wiring, 1-12

position references, inputs, 2-13

- line driver output, 2-13

- open collector output, 2-13

positioning complete signal, 2-63

positioning time, minimizing, 2-49

precautions, 1-2

pressure control, 2-33

proportional control, 2-51

proportional/integral control, 2-51

- signal, 2-12

protective sequence, 2-60

pulse dividing ratio, 2-20

R

radial load, 1-8

reference offset, 3-21

- automatic adjustment, 2-40, 2-48, 3-21

- manual adjustment, 2-40, 2-48

reference pulse

- form, 2-14

- input

- allowable voltage level, 2-16

- timing, 2-16

reference pulse inhibit function, 2-36

reference pulse input filter selection function, 2-37

residual voltage, precautions, 1-2

reverse rotation mode, 2-4

- user constant, 2-4

RS-232C port, 4-68

running output signal, 2-65

S

servo ON input signal, 2-62

Servomotors, 5-2

- 200-VAC SGM torque-motor speed characteristics, 4-15

- dimensional drawings, 4-28–4-71

- inspection, 5-2

- installation, 1-6

- maintenance, 5-2

- overhanging load, 4-26

- selection, 4-3

- flowchart, 4-5

- machine data table, 4-7

- test run, 1-24

- Servopacks, 5-3
 - AC, gain adjustment, A-2
 - dimensional drawings, 4-45
 - inspection, 5-3
 - installation, 1-9
 - instrument connection examples, 5-15
 - internal connection diagram, 5-15
 - maintenance, 5-3
 - overload characteristics, 4-25
 - position control
 - autotuning, A-8
 - manual adjustment, A-9
 - ratings, 4-18
 - for position control, 4-22
 - selection, 4-9
 - flowchart, 4-10
 - specifications, 4-18
 - for position control, 4-22
 - speed-control
 - autotuning, A-4
 - manual adjustment, A-5
 - test run, 1-26
- servos
 - alarm output, 2-60
 - alarm reset, 3-3
 - gain adjustment, 2-47, 2-49
- smoothing function, 2-47
 - position reference acceleration/deceleration time constant, 2-47
- soft start function, 2-32, 2-46
- software, version check, 3-26
- specifications
 - cables, 4-50
 - encoders, 4-54
 - communications, 4-68
 - magnetic contactor, 4-62
 - noise filter, 4-62
 - peripheral devices, 4-50
- speed bias, 2-52
- speed coincidence output signal, 2-64
- speed control, 2-11
 - zero-clamp, 2-11
- Speed Loop Compensation Function, 2-58
- speed reference offset, manual adjustment mode, 3-22
- speed references, 2-9
 - gain, 2-12
 - inputs, 2-9
- starting time, 4-26
- status display mode, 3-5
- stop mode, setting, 2-40

- stopping time, 4-26
- surge suppressor, 4-64

T

- tension control, 2-33
- terminals, standard-type motor without brake, 2-78
- test run, 1-23
 - minimum user constants, 1-30
 - motor alone, 1-24
 - position control from the host controller, 1-29
 - servomotor with brake, 1-29
- thrust load, 1-8
- torque control, 2-5, 2-32
- torque limit
 - input signals, 2-8
 - output signal, 2-6
- torque reference filter time constant, 2-48
- torque restriction function, 2-7
 - torque limit value, 2-7
- troubleshooting
 - alarm display, 5-4
 - without alarm display, 5-13

U

- user constant setting mode, 3-7
- user constants, 2-4
 - bias, 2-52
 - brake signal output timing during motor operation, 2-45
 - brake signal speed level output during motor operation, 2-45
 - contact input speed control selection, 2-29
 - control mode selection, 2-10
 - error counter clear signal selection, 2-17
 - feed-forward gain, 2-51
 - forward external torque limit, 2-7
 - forward rotation torque limit, 2-5
 - jog speed, 2-39
 - list
 - position control, C-5
 - speed/torque control, C-2
 - mode switch ON/OFF, 2-56
 - mode switch selection, 2-57
 - motor speeds, 2-29
 - overflow, 2-50
 - PI/P changeover, 2-51
 - position loop gain, 2-50
 - positioning complete range, 2-63
 - reference pulse form selection, 2-14

reference pulse inhibit function, 2-36
reference pulse input filter selection function, 2-37
reverse rotation mode, 2-4
reverse rotation torque limit, 2-5
rotation direction selection, 2-4
servo ON input signal, 2-62
soft start time, 2-30, 2-46
speed coincidence signal output width, 2-65
speed limit for torque control I, 2-35
speed loop gain, 2-49
speed loop integration time constant, 2-49
speed reference gain, 2-12
time delay from brake signal output to servo OFF, 2-44
torque control, 2-33
torque reference filter time constant, 2-48
torque reference gain, 2-35
zero-clamp speed control, 2-41
zero-speed level, 2-66

V

variable resistor, dimensional drawings, 4-64
vibration class, 4-17
vibration resistance, 4-17

W

wiring, 1-12, 2-67
 grounding, 2-70
 more than one servo drive, 2-73
 noise control, 2-69
 peripheral devices, 1-12
 precautions, 1-2, 2-67

Z

zero-clamp function, 2-12, 2-41

Revision History

The revision dates and numbers of the revised manuals are given on the bottom of the back cover.

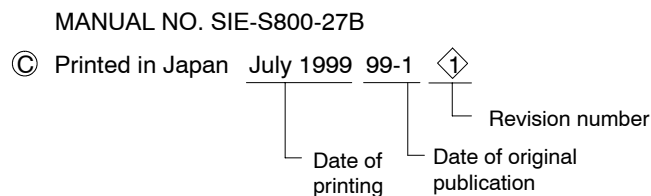

Date of Printing	Rev. No.	Section	Revised Content
January 1999	-	-	First edition
July 1999	◊ ₁	Back cover	Revision: Address
March 2000	◊ ₂	All chapters	Addition: 30-kW servomotors
February 2001	◊ ₃	Back cover	Revision: Address
December 2001	◊ ₄	All chapters	Revision: r/min→min ⁻¹ user constant→parameter
			Based on Japanese user's manual, SI-S800-27C<4> printed in December 2001.
November 2002	◊ ₅	Back cover	Revision: Address
May 2003	◊ ₆	Back cover	Revision: Address
April 2006	◊ ₇	Back cover	Revision: Address
April 2007	◊ ₈	4.2	Addition: Description of vibration resistance

Σ-mini Series SGMM/SGDF USER'S MANUAL

IRUMA BUSINESS CENTER (SOLUTION CENTER)

480, Kamifujisawa, Iruma, Saitama 358-8555, Japan
Phone 81-4-2962-5696 Fax 81-4-2962-6138

YASKAWA ELECTRIC AMERICA, INC.

2121 Norman Drive South, Waukegan, IL 60085, U.S.A.
Phone 1-847-887-7000 Fax 1-847-887-7370

YASKAWA ELÉTRICO DO BRASIL COMÉRCIO LTD.A.

Avenida Fagundes Filho, 620 Bairro Saude-Sao Paulo-SP, Brazil CEP: 04304-000
Phone 55-11-5071-2552 Fax 55-11-5581-8795

YASKAWA ELECTRIC EUROPE GmbH

Am Kronberger Hang 2, 65824 Schwalbach, Germany
Phone 49-6196-569-300 Fax 49-6196-569-312

YASKAWA ELECTRIC UK LTD.

1 Hunt Hill Orchardton Woods Cumbernauld, G68 9LF, United Kingdom
Phone 44-1236-735000 Fax 44-1236-458182

YASKAWA ELECTRIC KOREA CORPORATION

7F, Doore Bldg. 24, Yeoido-dong, Youngdungpo-Ku, Seoul 150-877, Korea
Phone 82-2-784-7844 Fax 82-2-784-8495

YASKAWA ELECTRIC (SINGAPORE) PTE. LTD.

151 Lorong Chuan, #04-01, New Tech Park 556741, Singapore
Phone 65-6282-3003 Fax 65-6289-3003

YASKAWA ELECTRIC (SHANGHAI) CO., LTD.

No.18 Xizang Zhong Road, Room 1702-1707, Harbour Ring Plaza Shanghai 200001, China
Phone 86-21-5385-2200 Fax 86-21-5385-3299

YASKAWA ELECTRIC (SHANGHAI) CO., LTD. BEIJING OFFICE

Room 1011A, Tower W3 Oriental Plaza, No.1 East Chang An Ave.,
Dong Cheng District, Beijing 100738, China
Phone 86-10-8518-4086 Fax 86-10-8518-4082

YASKAWA ELECTRIC TAIWAN CORPORATION

9F, 16, Nanking E. Rd., Sec. 3, Taipei, Taiwan
Phone 886-2-2502-5003 Fax 886-2-2505-1280



YASKAWA ELECTRIC CORPORATION

YASKAWA

In the event that the end user of this product is to be the military and said product is to be employed in any weapons systems or the manufacture thereof, the export will fall under the relevant regulations as stipulated in the Foreign Exchange and Foreign Trade Regulations. Therefore, be sure to follow all procedures and submit all relevant documentation according to any and all rules, regulations and laws that may apply.

Specifications are subject to change without notice for ongoing product modifications and improvements.

© 1999-2007 YASKAWA ELECTRIC CORPORATION. All rights reserved.

MANUAL NO. SIE-S800-27C

Printed in Japan April 2007 99-1 05-7⑦